

SelectaVision® VideoDisc System **CED** Basic Service Data

Model SJT 400

RCA Corporation
Consumer Electronics
Technical Publications
P.O. Box 1976 Indianapolis Indiana 46206

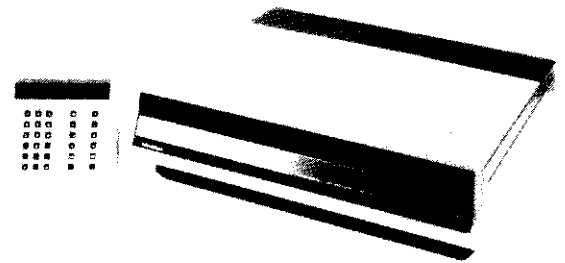

SJT 400

RCA Inc.
Technical Publications
5575 Royalmount Avenue Town of Mount-Royal Quebec, Canada H4P 1J8

Canada Stock Numbers:
Add prefix 62 to all stock numbers.

TO AVOID ERROR file all supplements and addendums as soon as received. Consult these before ordering parts.

Service Data Contents

	Page		Page
Abbreviations (Frequently Used)	9	Glossary	10
Adjustments		Integrated Circuit Block Diagrams	41
Electrical	23 thru 26	Instrument Disassembly	17 thru 22
Mechanical	16	Instrument Shipping	8
Alignment Stylus Lifter	69	Interconnect Wiring Diagram	43, 44
Circuit Boards		Mechanical Operation	12, 13
PW 400 Arm Preamp	60	Operating Controls & Functions	6
PW 600 AC Input	60	Replacement Parts	70 thru 76
PW 900 Remote I/R Preamp	60	Safety Precautions	2
PW 1000 Remote I/R Transmitter	68	Schematics	
PW 1700 Display	60	Audio—Stereo	52, 53
PW 6100 Features	54	Pickup Arm	45
PW Arm Interconnect	60	Player Control	46, 47, 48
PW Master	55, 56, 57	Power Supply	54
Circuit Protection	6	Remote Transmitter CRK36	68
Critical Copper Pattern	9	RKM/Features/OSD	58, 59
Component Numbering System	8	Signal Processing	49, 50, 51
Electrical Adjustment Location Guide	40	Service Alignment Disc Contents	11
Electronic Systems Description	14, 15, 16	Servicing Precautions	3, 4
Exploded Views		Specifications	5
Arm Assembly	67	Test Point and Active Device Location Chart	32 & 34
Arm Drive Assembly	67	Test Point and Active Device Identification	33
Cabinet and Mechanism	64, 65, 66	Turntable Height Adjust	16
Frequently Used Abbreviations	9	Voltage Charts	
Functional Block Diagram	61, 62, 63	Integrated Circuits	26 thru 29
Functional Block Diagram Features	42	Transistors	30, 31
General Information	7	Waveforms	35 thru 39

CAUTION: DO NOT USE MONAURAL ALIGNMENT (TEST) DISC STK. NO. 149235 WITH MODELS COVERED BY THIS SERVICE DATA.

SAFETY NOTICE

Components having special safety characteristics are identified by shading on schematics and by * stars on the parts list in this Service Data and its supplements and bulletins. Before servicing this instrument, it is important that the service technician read and follow the "Safety Precautions" and "Product Safety Notices" in this Service Data.

1. **Before returning the VideoDisc Player to the customer**, always make a safety check of the entire instrument, including, but not limited to, the following items.
 - a. Be sure that no built-in protective devices are defective and/or have been defeated during servicing (1) Protective shields are provided on this VideoDisc Player to protect both the technician and the customer. Correctly replace all missing protective shields, including any removed for servicing convenience. (2) When reassembling the VideoDisc Player, be sure to put back in place all protective devices, including, but not limited to, non-metallic control knobs, insulating fishpapers, adjustment and compartment covers/shields, and isolation resistor/capacitor networks. **Do not operate this instrument or permit it to be operated without all protective devices correctly installed and functioning. Servicers who defeat safety features or fail to perform safety checks may be liable for any resulting damage.**
 - b. Be sure that there are no cabinet openings through which an adult or child might be able to insert their fingers and contact a hazardous voltage. Such openings include, but are not limited to, (1) excessively wide cabinet ventilation slots, and (2) improperly fitted and/or incorrectly secured cabinet covers.
 - c. **Leakage Cold Check** — With the VideoDisc Player AC plug removed from any AC source, connect an electrical jumper across the two AC plug prongs. Place the VideoDisc Player AC switch in the on position. Connect one lead of an ohmmeter to the AC plug prongs tied together and touch the other ohmmeter lead in turn to each push button/customer control, exposed metal screws, metalized overlays and to each cable connector. If the measured resistance is less than 1.0 megohm or greater than 5.2 megohm (except for the center conductor of the F connector that feeds the TV receiver which will measure *open* when the function switch is in the play position) an abnormality exists that must be corrected before the VideoDisc Player is returned to the customer. Repeat this test with the VideoDisc Player AC switch in the *off* position. All the preceding tests should be made with a *Disc* in the player and repeated *without a Disc* in the player.

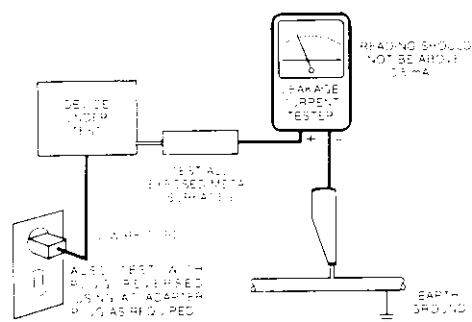

AC Leakage Test

d. **Leakage Current Hot Checks**

On completely assembled instrument, with a *Disc* in the Player and all tests repeated without a *Disc* in the Player, plug the AC line cord directly into a 120V AC outlet. (Do not use an isolation transformer during this test.) Use a leakage current tester or a metering system that complies with American National Standards Institute (ANSI) *C101.1 Leakage Current for Appliances* and Underwriters Laboratories (UL) *1410, (50.7)*. Measure for current, with the

player in the *play* position and repeat with the player in the *Load—Unload* and *off* positions from a known earth ground (metal waterpipe, conduit, etc.) to all exposed metal or conductive parts of the instrument (antenna connections, handle bracket, metal cabinet, screwheads, metallic overlays, push-buttons, control shafts, etc.), especially any exposed metal parts that offer an electrical return path to the Player deck. Any current measured must not exceed 0.5 milliamp. Reverse the instrument power cord plug in the outlet and repeat test.

ANY MEASUREMENTS NOT WITHIN THE LIMITS SPECIFIED HEREIN INDICATE A POTENTIAL SHOCK HAZARD THAT MUST BE ELIMINATED BEFORE RETURNING THE INSTRUMENT TO THE CUSTOMER OR BEFORE CONNECTING TO AN ANTENNA OR ACCESSORIES.

e. **Interconnected Equipment AC Leakage Test**

Avoid shock hazards. The television instrument, accessory, or cable(s) to which this VideoDisc Player is connected should have the applicable sections of the leakage resistance cold check and the leakage current hot check performed. Do not connect this VideoDisc Player to a TV antenna, cable or accessory that exhibits excessive leakage currents.

2. Read and comply with all caution and safety-related notes on or inside the VideoDisc Player cabinet, and on the Player deck.
3. **Design Alteration Warning** — Do *not* alter or add to the mechanical or electrical design of this VideoDisc Player. Design alterations and additions, including, but not limited to, circuit modifications and the addition of items such as auxiliary audio and/or video output connections, cables and accessories etc. might alter the safety characteristics of this VideoDisc Player and create a hazard to the user. Any design alterations or additions may void the manufacturer's warranty and may make you, the servicer responsible for personal injury or property damage resulting therefrom.
4. Observe original lead dress. Take extra care to assure correct lead dress in the following areas: a. near sharp edges, b. near thermally hot parts — be sure that leads and components do not touch thermally hot parts in the AC and DC supplies. Always inspect in all areas for pinched, out-of-place, or frayed wiring. Do not change spacing between components, and between components and the printed-circuit board. Check AC power cord for damage.
5. Components, parts, and/or wiring that appear to have overheated or are otherwise damaged should be replaced with components, parts, or wiring that meet original specifications. Additionally, determine the cause of overheating and/or damage and, if necessary, take corrective action to remove any potential safety hazard.
6. **PRODUCT SAFETY NOTICE** — Many electrical and mechanical parts have special safety-related characteristics some of which are often not evident from visual inspection, nor can the protection they give necessarily be obtained by replacing them with components rated for higher voltage, wattage, etc. Parts that have special safety characteristics are identified in RCA service data by *shading* on schematics and by a (*) in the parts list. Use of a substitute replacement that does not have the same safety characteristics as the recommended replacement part in RCA service data parts list might create shock, fire, and/or other hazards. Product Safety is under review continuously and new instructions are issued whenever appropriate. For the latest information, always consult the appropriate current RCA service literature. A subscription to, or additional copies of, RCA service literature may be obtained at a nominal charge from your RCA Consumer Electronics Distributor or from RCA Technical Publications, P.O. Box 1976, Indianapolis, IN 46206, or Canadian residents may order from RCA Inc., Technical Publications, 5575 Royalmount Ave., Town of Mount-Royal, Quebec H4P 1J8 Canada.

CAUTION: Before servicing instruments covered by this service data and its supplements and addendums, read and follow the **SAFETY PRECAUTIONS** on page 2 of this publication. **NOTE:** If unforeseen circumstances create conflict between the following servicing precautions and any of the safety precautions on page 2 of this publication, always follow the safety precautions. *Remember Safety First.*

General Servicing Precautions

1. Always unplug the instrument AC power cord from the AC power source before
 - a. Removing or reinstalling any component, circuit board, module, or any other instrument assembly.
 - b. Disconnecting or reconnecting any instrument electrical plug or other electrical connection.
 - c. Connecting a test substitute in parallel with an electrolytic capacitor in the instrument.

Caution: A wrong part substitute or incorrect polarity installation of electrolytic capacitors may result in an explosion hazard.
2. Do *not* spray chemical on or near this instrument or any of its assemblies.
3. Unless specified otherwise in this service data, clean electrical contacts by applying the following mixture to the contacts with a pipe cleaner, cotton-tipped stick or comparable nonabrasive applicator. 10% (by volume) Acetone and 90% (by volume) isopropyl alcohol (90% - 99% strength).

Caution: *This is a flammable mixture.*

Unless specified otherwise in this service data, lubrication of contacts is not required.

4. Do *not* defeat any plug/socket B+ voltage interlocks with which instruments covered by this service data might be equipped
5. Do *not* apply AC power to this instrument and/or any of its electrical assemblies unless *all* solid-state device heat sinks are correctly installed
6. Always connect the test instrument ground lead to the appropriate instrument chassis ground *before* connecting the test instrument positive lead. Always remove the test instrument ground lead *last*.

Electrostatically Sensitive (ES) Devices

Some semiconductor (solid state) devices can be damaged easily by static electricity. Such components commonly are called *Electrostatically Sensitive (ES) Devices*. Examples of typical ES devices are integrated circuits and some field-effect transistors and semiconductor "chip" components. The following techniques should be used to help reduce the incidence of component damage caused by static electricity.

1. Immediately before handling any semiconductor component or semiconductor-equipped assembly, drain off any electrostatic charge on your body by touching a known earth ground. Alternatively, obtain and wear a commercially available discharging wrist strap device, which should be removed for potential shock reasons prior to applying power to the unit under test.
2. After removing an electrical assembly equipped with ES devices, place the assembly on a conductive surface such as aluminum foil, to prevent electrostatic charge buildup or exposure of the assembly.
3. Use only a *grounded-tip* soldering iron to solder or unsolder ES devices.

4. Use only an *anti-static* type solder removal device. Some solder removal devices not classified as "anti-static" can generate electrical charges sufficient to damage ES devices.
5. Do *not* use freon-propelled chemicals. These can generate electrical charges sufficient to damage ES devices.
6. Do *not* remove a replacement ES device from its protective package until immediately before you are ready to install it. (Most replacement ES devices are packaged with leads electrically shorted together by conductive foam, aluminum foil or comparable conductive material.)
7. Immediately before removing the protective material from the leads of a replacement ES device, touch the protective material to the instrument ground or circuit assembly into which the device will be installed. **CAUTION:** Be sure no power is applied to the instrument or circuit, and observe all other safety precautions.
8. Minimize bodily motions when handling unpackaged replacement ES devices. (Otherwise harmless motion such as the brushing together of your clothes fabric or the lifting of your foot from a carpeted floor can generate static electricity sufficient to damage an ES device.)

General Soldering Guidelines

1. Use a grounded-tip, low-wattage soldering iron and appropriate tip size and shape that will maintain tip temperature within the range 500° F to 600° F.
2. Use an appropriate gauge of RMA resin-core solder composed of 60 parts tin/40 parts lead.
3. Keep the soldering iron tip clean and well tinned.
4. Thoroughly clean the surfaces to be soldered. Use a small wire-bristle (0.5 inch, or 1.25 cm) brush with a metal handle. Do not use freon-propelled spray-on cleaners.
5. Use the following unsoldering technique.
 - a. Allow the soldering iron tip to reach normal temperature (500° F to 600° F).
 - b. Heat the component lead until the solder melts.
 - c. Quickly draw away the melted solder with an anti-static, suction-type solder removal device or with solder braid.

CAUTION: Work quickly to avoid overheating the circuit board printed foil.
6. Use the following soldering technique:
 - a. Allow the soldering iron tip to reach normal temperature (500° F to 600° F).
 - b. First, hold the soldering iron tip and solder strand against the component lead until the solder melts.
 - c. Quickly move the soldering iron tip to the junction of the component lead and the printed circuit foil, and hold it there only until the solder flows onto and around both the component lead and the foil.

CAUTION: Work quickly to avoid overheating the circuit board printed foil.

 - d. Closely inspect the solder area and remove any excess or splashed solder with a small wire-bristle brush.

IC Removal/Replacement

Use the following technique for IC removal and replacement.

Removal

1. Desolder and draw away the melted solder with an anti-static suction-type solder removal device (or with solder braid) before removing the IC.

Replacement

1. Carefully insert the replacement IC in the circuit board.
2. Carefully bend each IC lead against the circuit foil pad and solder it.
3. Clean the soldered areas with a small wire-bristle brush. (It is not necessary to reapply acrylic coating to the areas.)

"Small-Signal" Discrete Transistor Removal/Replacement

1. Remove the defective transistor by clipping its leads as close as possible to the component body.
2. Bend into a "U" shape the end of each of three leads remaining on the circuit board.
3. Bend into a "U" shape the replacement transistor leads.
4. Connect the replacement transistor leads to the corresponding leads extending from the circuit board and crimp the "U" with long nose pliers to insure metal to metal contact, then solder each connection.

Power Output Transistor Devices Removal/Replacement

1. Heat and remove all solder from around the transistor leads.
2. Remove the heatsink mounting screw (if so equipped).
3. Carefully remove the transistor from the circuit board.
4. Insert new transistor in circuit board.
5. Solder each transistor lead, and clip off excess lead.
6. Replace heatsink.

Diode Removal/Replacement

1. Remove defective diode by clipping its leads as close as possible to diode body.
2. Bend the two remaining leads perpendicularly to the circuit board.
3. Observing diode polarity, wrap each lead of the new diode around the corresponding lead on the circuit board.
4. Securely crimp each connection and solder it.
5. Inspect (on the circuit board copper side) the solder joints of the two "original" leads. If they are not shiny, reheat them and, if necessary, apply additional solder.

Fuse and Conventional Resistor Removal/Replacement

1. Clip each fuse or resistor lead at top of circuit board hollow stake.
2. Securely crimp leads of replacement component around notch at stake top.
3. Solder the connections.

CAUTION: Maintain original spacing between the replaced component and adjacent components and the circuit board, to prevent excessive component temperatures.

Circuit Board Foil Repair

Excessive heat applied to the copper foil of any printed circuit board will weaken the adhesive that bonds the foil to the circuit board, causing the foil to separate from, or "lift-off", the board. The following guidelines and procedures should be followed whenever this condition is encountered.

In Critical Copper Pattern Areas

High component/copper pattern density and/or special voltage/current characteristics make the spacing and integrity of copper pattern in some circuit board areas more critical than in others. The circuit foil in these areas is designated as *Critical Copper Pattern* and is identified and illustrated in this service data in the section titled *Safety Related Copper Pattern* (see table of contents for page number). Because Critical Copper Pattern requires special soldering techniques to ensure the maintenance of reliability and safety standards, contact your local RCA Consumer

Electronics Distributor Service Manager before attempting repair of Critical Copper Pattern.

At IC Connections

To repair defective copper pattern at IC connections, use the following procedure to install a jumper wire on the copper pattern side of the circuit board. (Use this technique only on IC connections.)

1. Carefully remove the damaged copper pattern with a sharp knife. (Remove only as much copper as absolutely necessary.)
2. Carefully scratch away the solder resist and acrylic coating (if used) from the end of the remaining copper pattern.

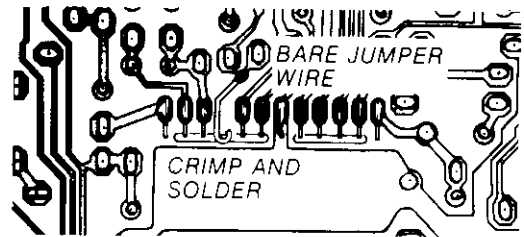

Install Jumper Wire and Solder

3. Bend a small "U" in one end of a small-gauge jumper wire and carefully crimp it around the IC pin. Solder the IC connection.
4. Route the jumper wire along the path of the cut-away copper pattern and let it overlap the previously scraped end of the good copper pattern. Solder the overlapped area, and clip off any excess jumper wire.

At Other Connections

Use the following techniques to repair defective copper pattern at connections other than IC Pins. This technique involves the installation of a jumper wire on the component side of the circuit board.

1. Remove the defective copper pattern with a sharp knife. Remove at least 1/4 inch of copper, to ensure that a hazardous condition will not exist if the jumper wire opens.
2. Trace along the copper pattern from both sides of the pattern break and locate the nearest component that is directly connected to the affected copper pattern.
3. Connect insulated 20-gauge jumper wire from the lead of the nearest component on one side of the pattern break to the lead of the nearest component on the other side. Carefully crimp and solder the connections.

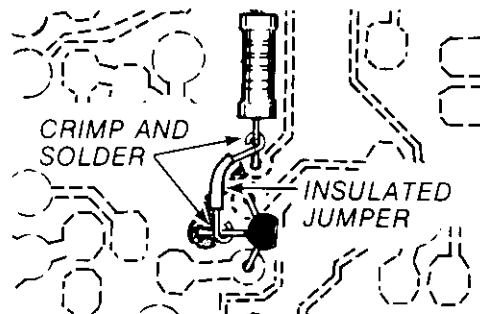

Insulated Jumper Wire

CAUTION: Be sure the insulated jumper wire is dressed so that it does not touch components or sharp edges. F013.4.2

Power Input: — 120 VOLTS, 50/60 Hz.
Power Consumption: — 31 WATTS
Antenna Impedence: — 75 ohm in/out
RF Output Level: — 3 mV Maximum
 1 mV Minimum
 Switchable to
 Channel 3 or 4
Circuit Boards: — PW 200 — RESONATOR
 PW 400 — Arm Preamp
 PW 600 — AC input
 PW 900 — Remote IR Preamp
 PW 1700 — Display
 PW 5600 — Function Switch
 Assembly
 PW 6100 — RKM/Features/OSD
 PW Hook up-Arm Interconnect

PW Master — Master Circuit Board
Weight: — Approx. 21 lbs.
Dimensions: — WIDTH — 17" (431.8 mm)
 DEPTH — 16-1/2" (418.9 mm)
 HEIGHT: — 5" (126.7 mm)
Turntable Speed: — 449.55 RPM Direct Drive
 Quartz-Locked
Play Time: — 2 hours (1 hour per disc side)
Video Signal System: — EIA Standard NTSC Color
 Signal
Video Output: — 1V p-p into 75-ohm termination 2V p-p
 unterminated
Audio Output: — 2 channel 200 mV ± 20 mV RMS, into
 10K ohm or greater impedance
Disc Play System: —  Capacitance
 Electronic Disc

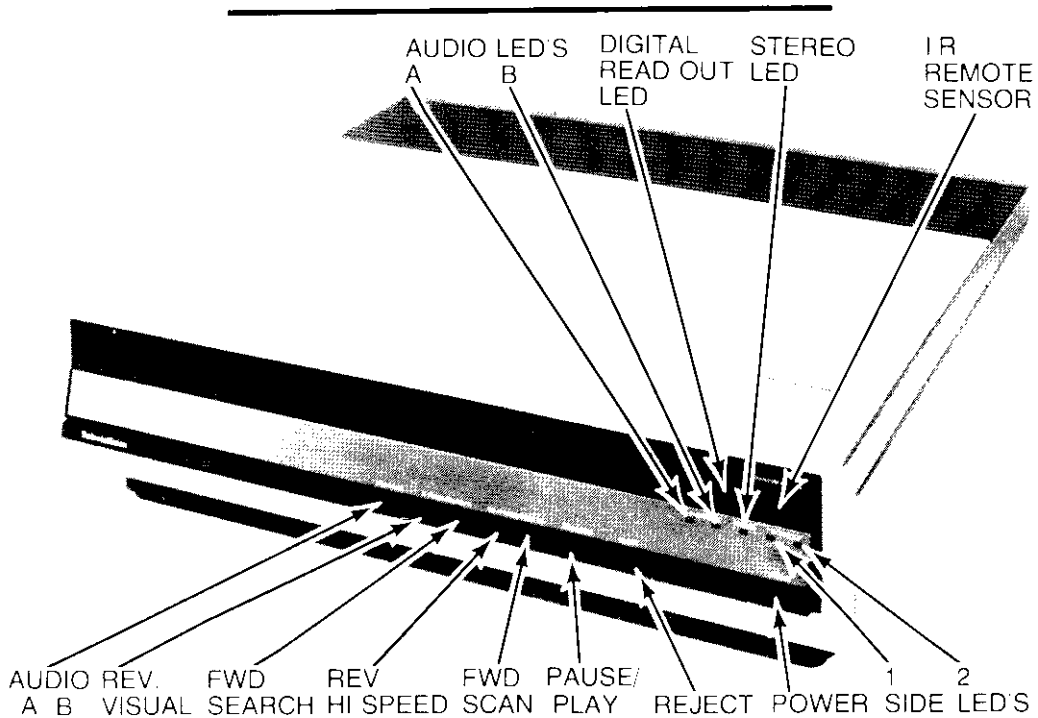

Fig. 1—Operating Controls

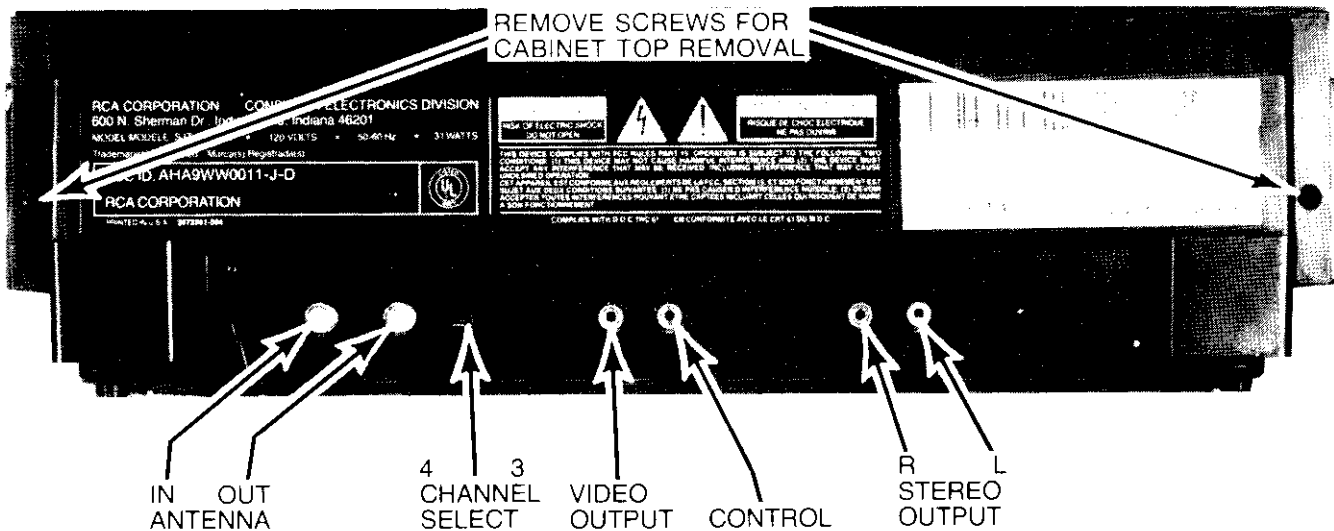

Fig. 2—Rear Panel Connections

NOTE: In addition to the LED Digital Readout indicator on the player, described in the following text, the SJT 400 RANDOM ACCESS VideoDisc player also has ON SCREEN DISPLAY capability which prompts the user in the operation of the instrument. See customer instruction book for more detail.

Power On/Off — Load — Play — Unload

Power is applied to the player by depressing the player on/off button. The player automatically places itself in the "Load" position (caddy entry door open). The digital readout indicator lights and displays a flashing "L".

To load player, insert loaded caddy into player gently until the player loading mechanism takes hold and pulls caddy into player (DO NOT force caddy into Player). When the caddy spine is latched the loading mechanism will reverse and return the empty sleeve (caddy) out beyond the caddy entry door opening. Remove the empty sleeve (caddy) from the player and the player will automatically place itself in the "Play" mode. During the automatic cycle the digital readout will display —●—. In approximately 10 seconds a picture will appear on the TV screen and the digital readout will begin to display elapsed playing time in minutes.

When "Play" is completed (approximately 60 minutes) the digital readout will display a flashing "E" momentarily then the "E" lights continuously. In approximately 8 to 10 seconds the player automatically places itself in the "Unload" mode. The digital readout will display a flashing "UL" and the caddy entry door will open. Insert empty sleeve (caddy), in same manner prescribed for load procedure, to retrieve the disc and spine from the player. Remove loaded caddy from player and the digital readout will then begin displaying a flashing "L".

Audio A/B Button

This function is active only when playing a special DUAL sound track or BILINGUAL disc. Press to select either the primary sound track "A" or the secondary sound track "B". Depending upon which sound track is active, the corresponding LED display lamp will light. (A/B).

Note: The player automatically selects the proper audio playback mode whether you are playing a special dual sound track, Bilingual, Stereo or monaural VideoDisc

Visual Search

Pressing either *Visual Search* Button, Fwd ► or Rev. ◀, (with disc in player) permits faster than normal (16 times normal speed) movement of the pick-up arm assembly. The stylus remains in contact with the disc permitting *Visual Search* (scan) viewing of the program material (audio is muted during this mode of operation).

Hi-Speed Scan

Pressing either *Hi-Speed Scan* Button, Fwd ►► or Rev. ◀◀ (with disc in player) permits rapid (120 times normal speed) movement of the pick-up arm Assembly. The stylus remains in contact with the disc permitting hi-speed scan (search) viewing of the program material (Audio is muted during this mode of operation).

Pause/Play

Pressing the "*Pause*" Button (with disc in player) places the stylus lifter circuit into operation raising the stylus off the disc. Video is blanked, audio is muted, and there is no movement of the pick-up arm assembly in this mode of operation. The digital readout will display a flashing "P". Pressing the "*Pause*" button a second time returns the player to normal operation. The in arm stylus cleaner (sweeper) is activated in the "Pause" mode.

Stereo Sound

By connecting an external stereo amplifier (optional equipment) to the stereo output jacks on the back of the player you can enjoy stereo sound when playing a stereo disc.

Video Out Jack

The video output jack (located on the back of the player) makes it possible to connect video from the player directly to a TV set or monitor equipped with a video input jack.

CIRCUIT PROTECTION

Fuse (or Device)

F601

Circuit Protected

AC input

Physical Location

PW 600

Note: Technicians servicing this product will find helpful the following related **RCA** Technical Training Publications.

VideoDisc Manual SJT200/300-1
VideoDisc Manual SJT400 TR

These publications may be ordered, for a nominal charge, from: RCA Technical Publications 1-450, P.O. Box 1976, Indianapolis, IN 46206.

The New RCA SelectaVision Random Access VideoDisc Player is simple to operate, and easy to install. External connections to and from the player are minimal, involving only intercept and reconnection of the television VHF antenna input lead (cable). Necessary connecting lead (cable) and matching transformers are included to handle all but unusual installations.

1. A 5 foot, 75 ohm coaxial cable connects from the antenna out connector on the player, to the VHF antenna input on the television receiver. Use cable direct if the television has 75 ohm VHF antenna input connector; use via a 75 to 300 ohm matching transformer/adaptor if the television VHF antenna input is 300 ohm.
2. A 300 to 75 ohm matching transformer/adaptor mates a 300 ohm twin lead antenna system (outside or rabbit ears) to the player 75 ohm antenna input system. (Captive, screw type lugs are integral to the 300 to 75 ohm antenna matching transformer/adaptor; strip and insert the 300 ohm twin lead wires then tighten the screws.) Keep in mind — for different or "odd" antenna systems — the antenna input and output of the Video Disc Player is 75 ohm unbalanced.

Antenna connection instructions should be carefully followed. The player produces an R-F signal which is transmitted on VHF Channel 3 or 4 (switch selectable) frequency. If the player antenna output is connected to an antenna, directly or in parallel from the television antenna input connections, the player may broadcast a signal. Broadcasting an unauthorized signal could violate certain regulations of the Federal Communications Commission regarding the operation of R-F devices. Recheck the installation to avoid any broadcasting possibilities; make sure the 75 ohm shielded cable is used to connect the R-F output of the player to the television receiver, and that no other connections are paralleled from these terminals.

The physical location of the antenna "in" and "out" connectors are depicted in the rear apron photo of the Video Disc Player (Fig. 2). "F" type connectors accept the VHF antenna input and output cables.

Interface of the antenna system, Video Disc Player, and monitor television receiver is controlled by an electronic antenna switch in the player. When the Player ON/OFF Switch is in the "OFF" position, the antenna is connected directly (via the player electronic antenna switch) to the television receiver and the television will operate normally. When the player ON/OFF switch is in the "ON" position, the antenna is disconnected and the player R-F output is connected directly to the television VHF antenna input connector. Under this condition the television receiver will receive a signal only on Channels 3 or 4 (switch selectable on the rear of Video Disc Player Fig. 2). Specifi-

cally the Video Disc Player antenna switch system serves to either connect the antenna system direct to the television VHF antenna input or disconnect the antenna system and connect the Video Disc Player R-F output direct to the television VHF antenna connector.

Stereo output jacks are available for connecting (cable included) stereo sound output to an external Stereo Amplifier (optional equipment). Also available is a Video Output Jack for connecting (cable not included) a video signal directly to a television receiver or video monitor equipped with video input capabilities.

The new design of the RCA VideoDisc player uses the single-main circuit board concept. The main circuit board contains nearly all of the electronic circuits. Circuits not contained on the main circuit board are AC input, resonator, pick-up arm preamp, and in the case of the remote controlled Random Access VideoDisc player, the remote preamp and remote control/Features/on screen display circuits.

Servicability of the new VideoDisc player is enhanced by the logical physical arrangement of circuits on the main circuit board. The board is segmented by **circuit area**. AND FURTHER ENHANCED BY PROMINENT ROAD MAPPING ON THE CIRCUIT BOARD. In addition, a component numbering system is used which relates to general circuit areas and will aid in readily locating individual components.

The SJT 400 VideoDisc player has the capability of random access to any area of the disc. Included with the unit is an infrared hand unit which allows the user to control all functions of the player except Power On/Off and caddy insertion/removal. Front panel buttons are provided to control simple functions of the player along with a two digit LED digital display device.

To assist the user during the *Remote Random Access* and *Program* operation, the player displays an on-screen message which indicates the operating state of the VideoDisc player, prompts the user with the appropriate action to be taken, and assists in programming the Random access features.

There are two IR remote units capable of controlling the random access VideoDisc player. The CRK-36 (furnished with the player) is dedicated solely to the control of the SJT 400 player. The CRK-32 (referred to as the Digital Command Center) can control not only the SJT 400 VideoDisc player but certain other RCA home entertainment products having IR controlled capabilities.

For complete CRK 36 IR Remote Random Access and Program operation instructions refer to SJT 400 Owner's Manual Part No. 2817354.

For complete CRK 32 IR Remote "Digital Command Center" operation instructions refer to RCA Technical publications File 1983 DCC-1.

Circuits not located on the Main Circuit Board and their numerical designation.

Component Numbering Versus Circuits.

- 0 - 99 — Mechanism/Player mounted components
- 100 series — PW Hookup on Arm assembly
- 200 series — Resonator on Arm assembly
- 400 series — Arm Preamp on Arm assembly
- 600 series — AC input
- 900 series — IR preamp
- 1700 series — Display board assembly
- 5600 series — Function Switch assembly
- 6100 series — RKM/Features/OSD

Circuits located on the Main Circuit Board and their numerical designation.

Component Numbering Versus Circuits

- 2000 series — Power Supply

- 2500 series — Pulse Interference Corrector (PIC)
- 2700 series — Video Output
- 3100 series — Non-Linear Aperture Correction (NLAC), Sound Beat Correction
- 3200 series — Video Demodulation
- 3300 series — Comb Filter/Defect Corrector
- 3400 series — Video Converter and Time Base Correction
- 3500 series — RF Modulator
- 4100 series — Audio Modulator
- 4200 series — Audio Track/Hold Mute (CMOS switch)
- 4300 series — Audio Matrix and Buffer
- 4400 series — Audio Decoder Rectifier
- 4500 series — Audio Decoder Control
- 4600 series — Audio Output
- 5100 series — Player Control
- 5300 series — Kicker Pulse
- 5900 series — Mechanism Control

INSTRUMENT SHIPPING

The customer instruction book advises the customer to retain the shipping tabs, original carton and packing material for use should they need to repack the player for moving or shipping.

To reinstall the shipping tabs for moving or shipping:

1. Be certain player is in "OFF" mode (caddy entry door closed).
2. Disconnect player from AC power and remove antenna Connections.
3. Replace shipping tabs (see illustrations).
4. Repack player in original carton for shipping using original packing material.
5. Be certain to include player accessories (antenna hook-up cable and adaptors, stereo hook-up cables and Remote transmitter) if instrument is being returned for service.

NOTE: Two different size shipping tabs are used. The large diameter pin shipping tab goes on the right side and the small diameter pin shipping tab goes on the left side.

Preparing The Player For Out-of-Carton Transport

When transporting the player out of original packing material, the following guidelines are recommended.

1. Be certain player is in "OFF" mode (caddy entry door closed).
2. Disconnect player from AC power source and remove antenna connections.
3. Replace shipping tabs (see illustrations).
4. Player can now be transported safely.

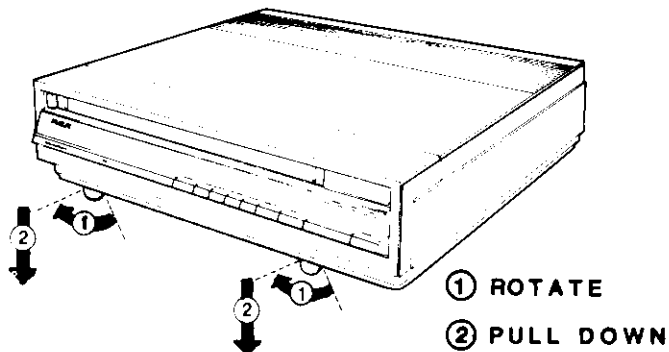

Shipping Tabs—Removal

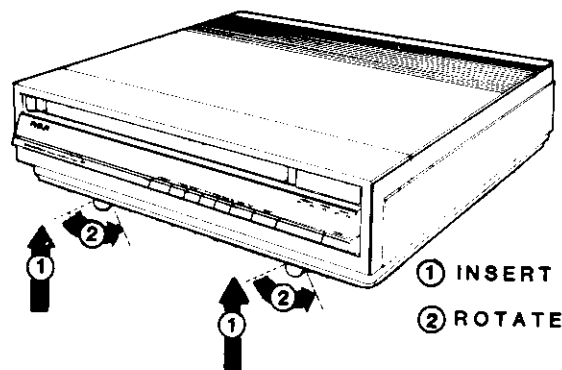

Shipping Tabs—Installation

AM — Audio Modulation	OSD — On Screen Display
AMA — Audio Mute Primary Channel A	P — Play
AMB — Audio Mute Secondary Channel B	PAU — Pause
ANX — Antenna Transfer	PLL — Phase Lock Loop
AO — Arm Output	RAF — Random Access Forward
AS — Arm Stretcher	RAR — Random Access Reverse
CAB — Channel A/B	RES — Reset
CO — Clock Output (or Chroma Output)	RKM — Remote Keyboard Microcomputer
CR — Caddy Reverse	RS — Radius Sense
CS — Caddy Sense	RSF — Rapid Search Forward
CV — Control Voltage	RSR — Rapid Search Reverse
CY — Cored Luminance	SB — Sound Beat
DD — Decoder Defeat	SC — Stylus Clean
DG — Defect Gate	SI — Side Indicator
DS — Display	SL — Stylus Lifter
FM — Function Motor (or Frequency Modulation)	SQ — Squelch
GND — Ground	SR — Sound Reference
HE — Hall Effect	SS — Spine Sense
HNC — Home Normally Closed	SWP — Sweeper (in Arm Stylus Cleaner)
HNO — Home Normally Open	TT — Turntable
Hz — Hertz	UNL — Unload
IC — Integrated Circuit	V — Voltage
KPO — Kicker Pulse Output	VB — Video Blanking
LA — Landing	VDO — Vertical Detail Output
LED — Light Emitting Diode	VR — Voltage Regulator
LO — Load	VSF — Visual Search Forward
LSE — Least Significant Digit Voltage	VSR — Visual Search Reverse
MA — Modulator Audio	Y — Luminance or B/W Video
MSE — Most Significant Digit Voltage	Z — Impedance
NS — Negative Supply	

SAFETY RELATED COPPER PATTERN

Modern circuit design/manufacturing techniques dictate a rather high component density on the printed circuit board utilized in this instrument. It naturally follows that the area available for "printing" copper patterns is also restricted. To maintain high reliability and safety standards, the printed circuit boards are manufactured under carefully controlled conditions and to extremely close tolerances. Some areas of the board are more critical than others due to spacing, pattern size, voltage/current requirements, etc. RCA has concluded, as a result of extensive studies that less-than-optimum repair of copper pat-

terns in these specific areas can degrade the reliability/safety of the instrument. The critical copper patterns are shown as "dark black" in the illustration (Fig. 3). In the event printed circuit damage is evident in these designated areas (copper pattern broken, lifted, etc.) special soldering techniques are necessary to maintain reliability and safety standards. Contact your local RCA Consumer Electronics Distributor Service Manager before attempting copper pattern repair in the designated areas on the board layout.

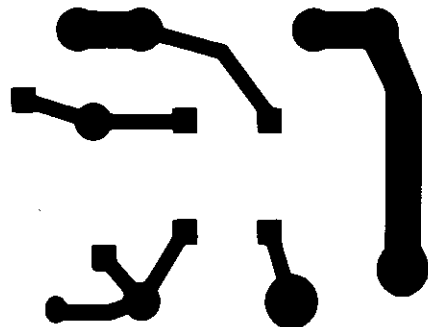

Fig. 3—PW 600 Critical Copper Pattern

- Analog** — Of or pertaining to the general class of devices or circuits in which the output varies as a continuous function of the input.
- Angstrom** — One tenth of a millimicron. Angstrom unit is a term utilized to express the length of very short waves.
- Beats** — A term used to describe the unwanted signals produced when two original signals are mixed together.
- Buried Subcarrier** — See Subcarrier, except frequency is down converted. Example: In CED system color burst is 1.53 MHz.
- Burst** — A short time occurrence (8 to 10 Hz) of the color subcarrier signal appearing right after Horizontal sync, but centered on the blanking portion of the video waveform.
- Caddy** — Name given to device in which the Video Disc is enclosed (see sleeve).
- Chroma** — The color portion of a video signal.
- D Flip-Flop** — A dual solid state processing circuit, the output of which is determined by the input.
- DAXI** — Digital Auxiliary Information recorded on the disc and utilized by the player control microcomputer to control operation of the disc player.
- Delta Frequency (Δf)** — A term to indicate that a signal or frequency has some variation or change.
- Dropout** — A momentary absence of carrier signal off the disc, whether due to uneven stamping or a particle of dust on the disc or stylus.
- Deviation** — A term used to describe how far the FM carrier frequency swings when it is modulated.
- Digital** — Of or pertaining to the class of devices or circuits in which the output varies in discrete steps (i.e., pulses or "ON-OFF" operation).
- Emphasis** — The process of boosting the level of the high frequency portions of the video signal.
- FM Signal** — Abbreviation for Frequency Modulated Signal.
- Field** — One half of a television picture. A field consists of 262.5 horizontal scanning lines across a picture tube. Two fields (line 1 thru 262.5 and line 262.5 thru 525 interlaced) are necessary to complete a fully scanned television picture (frame). The two sweeps of the TV picture tube, or two fields make up one complete TV picture or "frame". Frame repetition is 30 Hz, therefore field repetition is 60 Hz.
- Frame** — One complete television picture (see "Field").
- Gate** — A circuit which will deliver an output only when a specific combination of its inputs are present for use in analog or digital applications.
- Integrated Circuit (IC)** — An electronic device in which both active and passive elements are contained in a single package.
- Interlacing** — The property of the scan lines of two television fields to lie in-between each other.
- Interleaving** — A term used to indicate that the harmonics of the chrominance signal lie in-between the harmonics of the luminance portion of the video signal as it is viewed on a spectrum analyzer. This means that the color information of a video signal does not interfere with, although it is broadcast at the same time as, the luminance information.
- Jitter** — The name of an effect on the playback picture (sometimes referred to as "Wiggles" or "Flutter"). The picture appears to have a rapid shaking motion.
- Luminance** — This is the portion of the video signal which contains B/W information and sync (see "Y" signal).
- Micro Computer** — (μC) A compact and inexpensive computer relatively limited in capability and capacity, consisting of a microprocessor and other components of a computer, commonly used to store and process digital information.
- Micron** — One millionth part of a meter.
- Microprocessor** — (μP)— A miniaturized integrated circuit device which performs all of the functions of a central processing unit.
- NLAC** — Non Linear Aperture Correction — System which compensates for non-linear response of the stylus to the disc information.
- NTSC** — (National Television Systems Committee)— These four letters identify the United States Color Television Standard.
- PIC** — Pulse Interference Corrector—Circuit which detects and compensates for interference generated in the 900 MHz frequency range.
- Resonator** — A circuit that responds in accordance to oscillations produced in another circuit.
- Sample and Hold (S/H)** — A process by which the value of a particular signal is measured at a specific moment in time — then this signal is stored for later use.
- Servo** — Short for Servomechanism. An electromechanical device whose mechanical operation (for instance, motor speed) is constantly being measured and regulated so that it closely matches or follows an external reference.
- Sleeve** — Another name applied to the caddy in which the VideoDisc is enclosed. (See Caddy).
- Spine** — Device utilized in conjunction with the Video-Disc and caddy to support the disc when it is transferred from the caddy to the player.
- Stylus** — Diamond tipped device utilized to transfer video and audio information from disc to pickup arm assembly electronics.
- Subcarrier** — A carrier signal inserted within the pass-band of a broadcast signal to provide a channel for the transmission of additional information.
Example: In color TV, the 3.58 MHz color burst.
- VCO** — (Voltage Controlled Oscillator) An oscillator whose frequency of oscillation is governed by an external voltage and/or timing capacitor in IC applications.
- VCXO** — (Voltage Controlled Crystal Oscillator) Similar to VCO except that a quartz crystal is used as a reference.
- XTAL** — Abbreviation for Crystal.

Segment	Time Display (Minutes)	Video Display	On Screen Display	Audio**	Daxi Band	Audio Code	Service Application
A	72	Grey Field		S1: Unmodulated S2: Unmodulated	0	None	Stylus Landing Check
B	0 1	Grey Field w/ Time Count	0:00 1:12 2:12-3:12	S1: Unmodulated S2: Unmodulated	1		Stylus Landing Adjustment
C	2	Uniform Motion on Grey Field		1020Hz 100%	2	None	Audio Level Adjust Mono Player Visual Search FWD REV Check
D	6	Color Bars		S1: Unmodulated	3	None	Chroma and Video Adjustments General Picture Quality Check Stereo Indicator Check
E	10	100 IRE, White Field	100 IRE	S1: 480Hz 50% S2: 1020Hz 50%	4	Independent Not Encoded	Video Level Adjust Independent Audio Channel Test
F	13	Grey Field	Left Audio	S1: 1020Hz 50% S2: 1020Hz 50% In Phase	5	Stereo Encoded	Check and Adjust Stereo Separation Left Channel
G	15	Grey Field	Right Audio	S1: 1020Hz 50% S2: 1020Hz 50% Out of Phase	6	Stereo Encoded	Check and Adjust Stereo Separation Right Channel
H	19	120 IRE, 30% Window		S1: Unmodulated	7	None	Modulation Depth Adjust
I	23	5 Step Linearity w Defect		S1: Unmodulated	8	Mono Encoded	Defect Substitution Level Adjust
J	27	Unmodulated (5MHz Carrier)		S1: Unmodulated	None		5.11MHz VCO Frequency Adjust
K	31	Demonstration		S1: Demonstration S2: 1020Hz 100%	10	Independent Not Encoded	General Picture and Sound Check
L	35	Grey Field	No Audio Carriers		11	None	Sound Beat Check
M	39	Grey Field	Audio 1	S1: 1020Hz 100% S2: Unmodulated	12	Independent Not Encoded	Sound Beat Check
N	43	Grey Field	Audio 2	S1: Unmodulated S2: 1020Hz 100%	13	Not Encoded Independent-2	Sound Beat Check
O	47	Grey Field	Audio Decoder Reference	S1: 1020Hz 50% S2: Unmodulated	14	Stereo Encoded	Decoder Testing and Audio Output Measurement
P	49	Grey Field	Audio, -30db	S1: 1020 Hz 15.8% S2: Unmodulated	15	Stereo Encoded	Decoder Testing and Adjust
Q	51	Grey Field	Audio, -20db	S1: 1020Hz 5% S2: Unmodulated	16	Stereo Encoded	Decoder Testing
R	53	Grey Field	Audio, -10db	S1: 1020Hz 15.8% S2: Unmodulated	17	Stereo Encoded	Decoder Testing
S	56	Uniform Motion on Grey Field		S1: Unmodulated S2: Unmodulated	18	Stereo Encoded	Visual Search Check Background Noise Level Check
T	60	Vertical Lines w/ Time Count	0:00	S1: Unmodulated S2: Unmodulated	19	Independent	Armstretcher Check and/or Adjustment
U	62 E	Grey Field w/ Time Count	2:00 E	S1: Unmodulated S2: Unmodulated	63	None None	Daxi Signal Check For End of Recording
V	63	Grey Field w/ Time Count	3:00-5:00	S1: Unmodulated S2: Unmodulated	20	Independent Not Encoded	Arm Travel Limit Check

Note: Time count in Bands T, U and V is continuous (i.e.), clock does not reset at the beginning of bands U and V. To access Band V, Rapid Access FWD must be used. Segment V ending time will depend on arm stop.

* See Service Data for use of pre-program segments of Bands A and B.

** Unless otherwise noted, Modulation/Deviation shown is for S1 only, and S2 is not present. (S1 = 716kHz carrier; S2 = 905kHz carrier).

*** Time Display will not increment when Daxi Band is not present (Segment J) and "In Arm Sweeper" will operate continuously.

Load Sequence

Pressing the on/off button (turning player on) applies power to the Function Motor. The function motor (running in the forward mode), drives the pulley and 1st reduction gear and the pinion and 2nd reduction gear which in turn drives the upper and lower power assist gears and caddy rollers. The upper power assist gear drives the power assist hub and rod assembly transferring power to the pawl drive gear that in turn drives the function gear. The function gear, as it rotates to the load position opens the caddy (sleeve) entry port door through mechanical linkage, operates the disc transfer rod and activates the mechanism load switch (S9). The digital display will display a flashing "L" indicating the player is in the "Load" mode (See Fig. 4).

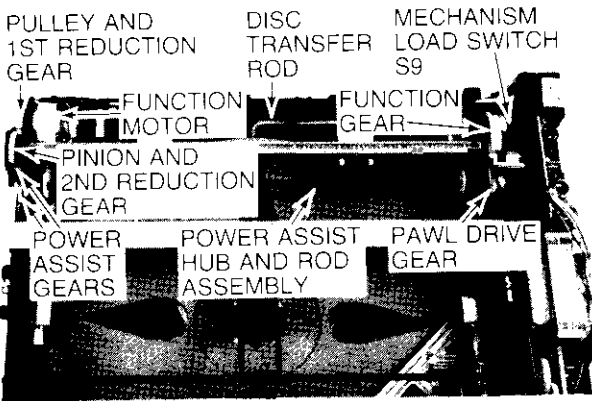

Fig. 4—Mechanism Identification

Insertion of the loaded Caddy (sleeve) into the player first encounters the Pawl Actuating Crank lever which, through mechanical linkage, places the function gear actuating pawl in a non-actuating position. Encountered next the spine holddown pads, caddy lockout assemblies, and front receiver pads are raised and lowered respectively to allow caddy (sleeve) entry. The spindle receiver is then raised, the side receiver pads lowered and the caddy (sleeve) sense switch S4 activated (closed) by the caddy (sleeve).

When the caddy sense switch, S4, is activated (closed), power is applied to the function motor. The caddy (sleeve) rollers begin to rotate, they grasp the caddy (sleeve) pulling it into the player. The caddy (sleeve) then activates (closes) the caddy reverse switch, S8. As caddy (sleeve) insertion nears completion the rear receiver pads are lowered, the caddy (sleeve) lock defeat tabs enter the end of the caddy (sleeve) on either side unlocking the spine tabs which hold the spine and Video Disc captive in the caddy (sleeve). At the same time the spine latch tabs, are pushed up and over the end of the spine and drop into their latching position holding the spine and Video Disc captive in the player. The spine sense switch, S5, is also activated (closed) at this time and the side indicator switch, S6, is either activated (closed) or left "off" (open) depending upon which side of the disc is being played. The function motor stops for approximately one (1) second before it begins running in the reverse mode (See Figs. 5 & 6).

With the function motor running in the forward mode the caddy (sleeve) rollers will be driven in the reverse mode. This causes the caddy (sleeve), now empty, to be ejected automatically to a point just beyond the caddy (sleeve) entry door where it must then be manually removed.

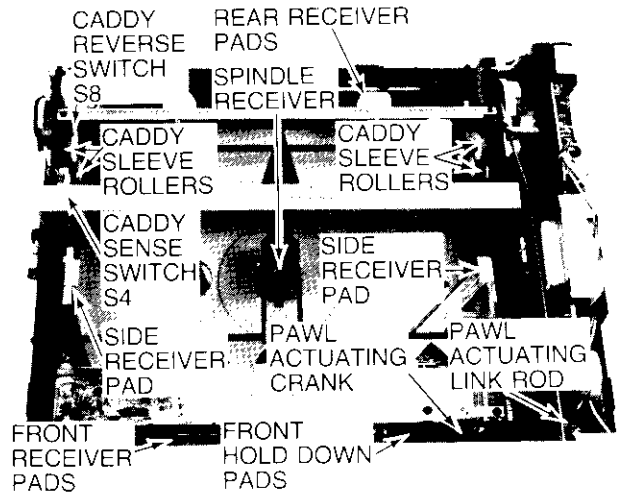

Fig. 5—Mechanism Identification

As the caddy (sleeve), now empty, begins its ejection travel from the player—the caddy (sleeve) lock defeat tabs (spring loaded) pop up above the spine to the position necessary for performing their function during the "unload" process. The rear receiver pads rotate up to their normal position to support the disc and spine. The caddy (sleeve) reverse switch, S8, is deactivated (opens), however the function motor continues to run. When the caddy (sleeve) is released by the caddy rollers it must then be manually removed from the player—the caddy sense switch, S4, is deactivated (opens), the side receiver pads (spring loaded) raise up to support the spine, the front receiver pads (spring loaded) raise and the spine holddown pads (also spring loaded) lower to support the disc and spine. The last item to be released is the Pawl Actuating Crank, which is used to prevent the function gear actuating pawl from being tripped during the time a caddy (sleeve) is in the player (See Figs. 5 & 6).

Note: The function motor, now controlled by the mechanism μ C, is still running in the forward mode.

Immediately upon release of the pawl activating crank the function gear actuating pawl is released, through mechanical linkage, and allowed to revert to its normal position. On the very next rotation of the pawl drive gear it strikes the function gear pawl placing the function gear

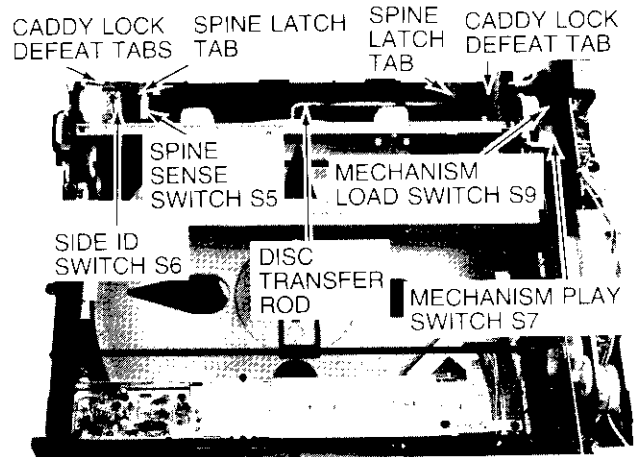

Fig. 6—Mechanism Identification

Continued next page

teeth in contact with the pawl drive gear teeth, thus driving the function gear through its rotation. As the function gear is driven through its rotation several mechanical functions occur (via cams which are an integral part of the function gear) that operate mechanical linkage. The rear receiver pads are moved back slightly and the front receiver pads are moved forward slightly to allow the disc to be lowered onto the turntable. The caddy (sleeve) entry door is closed, the disc is lowered onto the turntable by the Disc Transfer Rod and the mechanism play switch, S7, is activated (closed). With the activation (closing) of the mechanism play switch the turntable powers up and the arm assembly is moved into position over the disc, the stylus drops making contact with the disc producing picture and sound on the monitor television.

Note: A time lapse of approximately 10 seconds is required from turntable power up until picture and sound appear on the monitor TV.

Stylus Clean

The stylus is cleaned during the time the arm assembly is moved forward from its "home" position to its "play" position over the disc. The stylus cleaner pad is spring loaded and moves forward on an angle controlled by the arm assembly. About half-way through the forward movement of the stylus cleaner pad assembly the arm assembly hesitates (stops momentarily), the stylus is dropped and then the arm assembly and stylus cleaner pad continue their forward movement dragging the stylus across the cleaner pad in a parallel path cleaning the stylus. Almost immediately the stylus lifter circuit is activated lifting the stylus off the cleaner pad. When the stylus cleaner pad reaches the end of its travel the arm assembly continues its forward movement and positions itself over the disc at a predetermined starting point controlled electronically by activation of Landing Switch S10, contacts 1 & 2. The stylus is then dropped onto the disc to begin its function during the "Play" process (See Fig. 7).

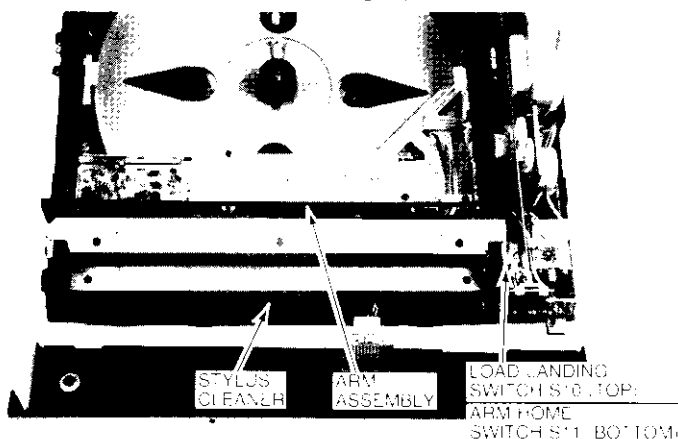

Fig. 7—Stylus Clean

Unload

At "end-of-play" the digital display will display a flashing "E" for a period of approximately four (4) seconds, then display a non-flashing "E" during the time the arm assembly is being returned to its "Home" position. When the arm assembly reaches its home (outermost) position, Landing Switch, S10, is deactivated (open) and Arm Home switch, S11, is activated (terms 1 & 3 closed). The stylus cleaner pad is also forced to its outermost position by the arm assembly and the turntable electronically seeks its locked position.

When the arm assembly reaches its Home position Arm Home switch, S11 opens permitting the function motor to be activated in the reverse mode. With the function motor running in the reverse mode the function gear is rotated through its cycle opening the caddy (sleeve) entry door, through mechanical linkage, and the VideoDisc is raised to the "unload" position by the Disc Transfer Rod.

NOTE: There is a 5 minute time-out period in the "unload" mode. If the disc and spine is not removed during this period the disc is returned to the turntable and the player places itself in the "Pause" mode.

Insert empty caddy (sleeve) through the caddy (sleeve) entry port door in the same manner used when the player was loaded. The same series of events will occur as occurred during the "Load" sequence with the following exceptions. The caddy (sleeve) makes contact with the caddy lock defeat tabs (these are the tabs used to release the spine and VideoDisc from the caddy during the "load" process and sprang up when the caddy was removed) forcing them up over the caddy (sleeve) which in turn forces the spine latch tabs to release the spine. The spine and VideoDisc are forced into the empty caddy (sleeve) by the spine push back springs locking it securely. The caddy (sleeve), with the spine and disc locked securely inside, can now be safely ejected by the caddy rollers. When the caddy (sleeve) is removed past the caddy sense switch S4, the switch is deactivated removing power from the function motor. The player automatically reverts to the "Load" mode. At this time the loaded caddy may be turned over and re-loaded in the player to play the other side of the Video Disc. **DO NOT** leave the player in the "Load" mode for any extended period of time. Dust or other contaminates could enter the mechanism through the open caddy entry port door and cause damage to the unit (See Fig. 8).

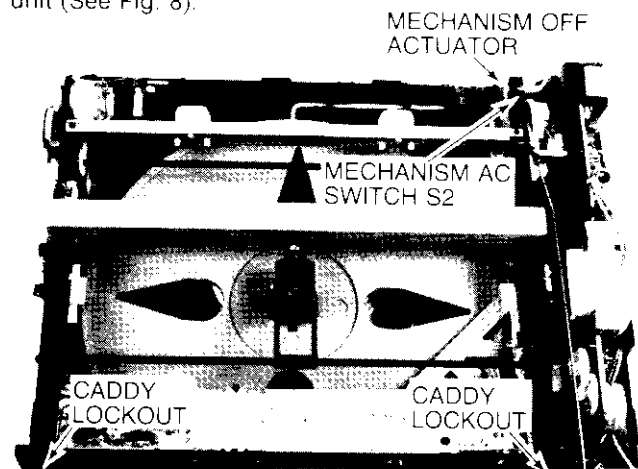

Fig. 8—Unload and Off

Off Position (Disc and spine removed)

Pushing the "OFF" button (to turn player off) makes the player think it has been loaded with a disc. The function motor runs in the forward mode operating the function gear which begins rotating as if to drop a disc on the turntable. However with no spine in the player the mechanism "OFF" actuator comes into play. At about half-rotation of the function gear, a cam (an integral part of the function gear) forces the mechanism "OFF" actuator up against mechanism AC switch, S2, turning it off (open) removing AC power from the player. The same cam also operates

mechanical linkage which closes the caddy entry port door and holds the Lockouts and Pawl Actuating Crank rigid preventing insertion of a loaded caddy into the player in the "OFF" position (See Fig. 8).

Fig. 46 is a Functional Block Diagram of RCA VideoDisc Player model SJT400. The Front panel control buttons and digital display allow the user direct control of the primary functions of the player. In its primary functions, model SJT400 operates the same as the SJT 200/300 VideoDisc Players.

Most of the electronic circuits in model SJT400 can be separated into two (2) basic categories; PLAYER CONTROL and SIGNAL PROCESSING. One large Master Circuit Board contains the majority of electronic circuits for player control and signal processing while the PW 6100 circuit board assembly contains the RKM/Features/OSD electronic circuits (Fig. 31—is a Functional Block Diagram of the PW 6100 Features Circuit Board).

Three (3) microcomputer (μ C) integrated circuit devices are the heart of the player control function. The remote control μ C (RKM) which is located on the Features circuit board, accepts and decodes all input commands from the IR Remote transmitter (CRK36 or CRK32) and the user primary control buttons (located on the player itself).

After the input commands have been decoded and the corresponding output data extracted from the Features control software, the output commands are then transferred via unibus lines to the Features μ C. The Features μ C further processes the information and produces output data for On Screen Display, Side 1-Side 2 identification, antenna transfer and player control. The Feature μ C and the player μ C (located on the Main Circuit Board) then work together to control operation of the player. The Player Control μ C also decodes the **Digital Auxiliary Information (DAXI)** on the VideoDisc which is used by the Features μ C and Player Control μ C to control various functions of the player electronics and mechanism.

The signal processing circuits are equipped with several integrated circuits and discrete devices, the majority of which are mounted on the master circuit board assembly with the remainder being on the pick-up arm assembly. The signal processing circuits detect the video and audio information on the VideoDisc, demodulates it and processes it through a comb-filter circuit, and then modulates it onto either a channel 3 or channel 4 television RF carrier. This modulated television RF carrier signal is then connected through coaxial cable to any NTSC television receiver.

Functional Operation

Operation of the VideoDisc player is totally controlled by the combined efforts of the RKM, Features and Player Control microcomputer devices. When the user selects a mode of operation—be it by way of the IR remote system or the "On Player" primary function buttons—input commands related to that mode are fed to the RKM μ C. The RKM μ C decodes these input commands and develops Digital Data which is transferred to the Features μ C. The Features μ C decodes the digital data it receives from the RKM μ C and develops additional digital data. This data is then used to develop the on screen Display, Side 1/Side 2 indication, antenna transfer and to establish communications between the Features μ C and Player Control μ C (located on the master circuit board). The Player Control microcomputer decodes these input commands and, in turn, uses the decoded information to "direct" other player control electronics to establish the electrical conditions required to perform the selected mode of operation. The

state of all signal processing circuits is controlled by the Not Squelch (**SQ**) output of the player control microcomputer. When the Not Squelch line goes to a logic "Lo" state, all of the signal-processing electronic circuits are disabled (squelched).

The player control microcomputer has direct control over the pickup arm assembly and the mechanism control microprocessor. This involves:—operation of the Function motor (to "Load" and "Unload" the player); — the turntable motor; — the arm drive (stepper) motor operation, moving the arm forward (Toward center of disc) during normal play — the stylus lifter operation, raising and lowering the stylus as the various functions are initiated; — and the stylus kicker circuits, enabling the system to provide the VISUAL SEARCH feature. The player control microcomputer also controls the direction of the arm drive (stepper) motor. In the HI SPEED SCAN REVERSE, and VISUAL SEARCH REVERSE operating modes, the microcomputer instructs the arm drive (stepper) motor to operate in the reverse mode. The player control microcomputer also generates the elapsed play time display. The time display information is developed from the Digital Auxiliary Information (DAXI) signal. This signal is pre-recorded on the VideoDisc on line 17 of each vertical field. The DAXI signal includes a field identification number that is decoded by the player control microcomputer. This decoded information is used by the microcomputer to develop the elapsed time display.

The signal processing electronics on the pickup arm assembly detect information recorded on the VideoDisc. The arm also contains components for providing the features of VISUAL SEARCH FORWARD and REVERSE as well as locked groove protection. They are: the "stylus kicker" coils which will cause the stylus to skip two grooves of the Video Disc; the "armstretcher" transducer which corrects for the timebase variations in the recovered chrominance and luminance signals. The arm assembly of VideoDisc player Model SJT 400 also contains an **in arm** stylus sweeper which is activated when the player goes into carrier distress (loses DAXI) and does so for a period of 3 seconds more. It is also activated each time the player is placed in the "Pause" mode.

The primary function of the pickup arm signal processing electronics is to detect the information recorded on the Video Disc. This is accomplished by modulating a 910 MHz VHF resonator circuit with the capacitance changes on the VideoDisc surface. The variations in capacitance on the VideoDisc surface causes the 910 MHz resonator center frequency to be modulated. This, in turn, amplitude modulates a fixed 915 MHz oscillator signal. The signal is then peak detected, with the resultant signal representing the capacitance variations on the VideoDisc. The signal is then preamplified and AFT controlled before being applied to the remaining signal processing electronics. The Arm Output (AO) signal contains the video and audio FM-modulated carrier information and all of the information (DAXI) necessary for player control.

The AO signal is applied to the Main Circuit Board assembly where it is distributed to the player control electronics, the video signal processing electronics, and the audio processing electronics.

In the signal processing electronics of the stereo VideoDisc player the AO signal is applied to three (3) FM demodulator ICs. One (1) for video processing and two (2) for audio processing.

In the case of a Monaural VideoDisc a single audio track is imprinted on the disc at 716 kHz. In the case of a stereo or bilingual VideoDisc two (2) audio tracks are imprinted on the disc. One at 716 kHz, the other at 905 kHz.

Before the AO signal is applied to the Video Demodulator IC, it is passed through a Non Liner Aperture Correction (NLAC) circuit. The NLAC circuit removes the 716 kHz audio modulation from the video information. It does this by phase inverting the audio modulation, and then adding it back to the original signal. This cancels out the 716 kHz audio modulation in the carrier information. The video FM carrier, with the 716 kHz audio modulation removed is then applied to the Video demodulator IC and a Pulse Interference Corrector (PIC) circuit.

The purpose of the Pulse Interference corrector (PIC) circuit is to prevent radar and other strong RF pulses in the 900 MHz range from interfering with the operation of the VideoDisc Player. The PIC circuit detects the presence of such pulses and instructs the defect corrector in the Comb Filter and Defect Corrector integrated circuit to substitute the previous line of video information.

The Video Demodulator IC, which demodulates the video carrier, also contains a defect detector circuit used to activate the defect corrector in the comb filter IC. Thus allowing a portion of the previous horizontal line to be inserted when a defect caused by loss of carrier occurs. The output of the video demodulator, being composite video with "buried" subcarrier chroma, is then applied to a comb-filter circuit. The comb-filter dynamically separates chrominance and luminance information from the composite video information. The output of the comb filter is "combed" chrominance and "combed" luminance. The combed chrominance output signal contains low frequency luminance information and the DAXI signal which is transmitted with each vertical field. After bandpassing the 1 to 2 MHz chroma signal, the two remaining signals (low frequency luminance and DAXI) are separated by low pass filters. The low frequency luminance information is recombined with the "combed" luminance information to provide the luminance output. Vertical Detail Output (VDO) containing the DAXI signal is supplied via the DAXI buffer IC to the player control microcomputer.

The luminance and chrominance information is coupled from the comb-filter circuit to the video converter circuit. The video converter up-converts the 1.53 MHz chrominance information to 3.58 MHz. The 3.58 MHz chroma and the luminance information are then combined. The resultant composite video signal is then supplied to the RF modulator where the demodulated audio signal is added and a RF signal on channel 3 or channel 4 is developed for output to a standard NTSC television receiver.

Also developed in the video converter stage is the drive signal for the "Armstretcher" time base corrector circuit. The correction signal is developed by comparing the up converted 3.58 MHz. chroma information with a crystal controlled 3.58 MHz reference oscillator. Any phase or frequency difference between the two signals develops an error signal which is applied to the arm-stretcher circuit. The armstretcher circuit operates a solenoid (located on the pick up arm assembly) moving the stylus (laterally with respect to the disc) to maintain a constant disc to stylus velocity. The armstretcher circuit output is also coupled to the converter oscillator (5.11 MHz VCXO) in order to maintain phase lock between the up converted 3.58 MHz color signal and the crystal controlled 3.58 MHz reference oscillator.

A Video Noise Coring circuit is used in conjunction with the video converter circuit to eliminate high frequency signals below 5 IRE peak-to-peak from the composite video output signal. The "combed" luminance signal is capacitively coupled to a noise coring amplifier stage where it is inverted. The inverted signal is then direct coupled to

a non-inverting noise coring buffer stage. The non-inverted signal is coupled back to the input circuit of the noise coring amplifier stage through a coring circuit consisting of a coupling capacitor and two (2) coring diodes. This represents a negative feedback of all signals above 5 IRE peak-to-peak which is 180 degrees out-of-phase with the incoming signal. Therefore all signals above 5 IRE will be cancelled at the input of the noise coring amplifier stage. Hence, the signal at the output of the noise coring buffer stage will contain only signals below 5 IRE peak-to-peak. This signal is then added, 180 degrees out-of-phase, to the composite video signal from the video converter IC. The result being elimination of high frequency signals below 5 IRE peak-to-peak from the composite video output signal, thus reducing high frequency noise in the video information.

Audio Signal Processing

As previously stated, in the case of a monaural VideoDisc a single audio track is imprinted on the disc at 716 kHz. The AO signal is applied to a Band pass filter which passes only the 716 kHz audio FM information. This information then is applied to the 716kHz Audio FM Demodulator IC. After demodulation the signal is coupled to a Sample and Hold CMOS switching IC. The audio signal then is capacitively coupled to the RF Modulator circuit.

In the case of a Stereo or Bilingual VideoDisc two (2) separate audio tracks are imprinted on the disc—one at 716 kHz the other at 905 kHz. The AO signal is applied to two (2) Band Pass Filters one of which passes only the 716 kHz audio signal and the other passes only the 905 kHz audio signal. The audio signals are then applied to two (2) audio demodulator IC's. The 716 kHz signal is processed by the (L+R) audio demodulator IC and the 905 kHz is processed by the (L-R) audio demodulator IC.

The signals are then routed through a TRACK/HOLD and MUTE CMOS Switching IC. The (L+R) signal is applied to a non-inverting OP Amp and then to the base of the Right and Left channel audio buffer stages. The (L-R) is applied to a non-inverting OP Amp and then to the base of the Left channel audio buffer stage. It is also applied to an inverting OP Amp, which provides the necessary inversion of the (L-R) signal, the output of which is applied to the base of the right channel audio buffer stage.

Separation takes place in the base circuit of the left and right channel audio buffer stages. With both (L-R) and (L+R) signals present at the base of the left channel audio buffer the right channel information is cancelled leaving only the left channel information at its output. Likewise with both $[(L-R)]$ and (L+R) signals present at the base of the right channel audio buffer the left channel information is cancelled leaving only the right channel information at its output.

The output of the left and right audio buffers (now separated audio) is applied to three (3) circuits. First is the transconductance audio output amplifier IC; second the right and left audio signals are applied to the noise reduction decoder circuit which generates a gain control signal and couples it back to the transconductance audio output amplifier; third, the right and left audio signals are summed together and coupled via the CMOS switching IC to the RF modulator circuit. After final amplification by the audio output IC the audio signals are then de-emphasized and applied to their respective audio output jacks.

The ON or OFF state of the Track/Hold and Mute electronic CMOS switching IC is electronically determined by the DAXI code imprinted on the VideoDisc being played.

Continued next page

In the case of a monaural disc, the portions of the CMOS switch IC Controlled by pins 5, 6 & 13 (pins 5, 6 & 13 go to high state) will be activated allowing the 716 kHz (or right channel audio) to be passed for processing. In the case of a stereo disc, the portions of the CMOS switch IC controlled by pins 5, 6 & 12 (pins 5, 6 & 12 go to high state) will be activated allowing both the 716 kHz (right channel audio) and 905 kHz (left channel audio) to be passed for processing. In the case of a bilingual Video Disc, the state of the CMOS switches depends on which audio channel you choose to operate. If you choose to operate primary channel "A", CMOS switching IC pins 5, 6 and 13 will be "high" allowing only channel "A" (716kHz) information to be passed for processing. If you choose secondary channel "B", CMOS switching IC pins 12 and 13 will be "high" allowing only channel "B" (905 kHz) information to be passed for processing.

Muting is accomplished by placing pins 5 and 12, of the CMOS switching IC, in a "low" state thereby opening their respective switch sections.

Decoder Operation

The original Stereo audio signal stamped onto the VideoDisc is compacted from a dynamic range of (+12db to -40db) to (+6db to -20db) for recording on the disc itself. To reproduce the original stereo audio signal a decoder system has been incorporated in the "Stereo" VideoDisc Player audio signal processing circuitry. The audio signal from each channel is coupled via a 100 Hz high pass filter into a pair of Op Amps. One is an inverting amp the other noninverting. All four of these Op Amps, tied together at their outputs, perform like a full wave rectifier. Another Op Amp, whose output is controlled by a fixed bias, sets the output of the rectifier stages. This permits a maximum signal expansion of (-20db) changed to (-40db) point level. The output of the rectifier Op Amps is then coupled to a decoder Op Amp (works like a filter) whose output is applied to another decoder Op Amp (a DC amp) creating a variable DC voltage at its output. This variable DC voltage is then processed by a time constant network which performs the actual decoding function.

The output of the time constant network is then applied to an additional Op Amp. The output of this Op Amp (also a variable DC voltage) is used to control the current flow through a Current source transistor. The output of the current source transistor then is used to control the gain of the transconductance amplifier stages for both the Left and Right Channel audio output.

Note: The decoder circuit is operational only when playing a Stereo encoded (compacted) VideoDisc. When a monaural or bilingual VideoDisc is being played a fixed bias is applied to the Op Amp immediately preceding the decoder time constant network. This in turn places a constant bias on the Transconductance amplifier stages in the Audio Output Integrated Circuit.

On Screen Display

The SJT400 provides on screen display information prompting the user during operation of the instrument. Player video information, after processing by the video converter IC on the master circuit board, is applied to a video mixer stage on the PW 6100 circuit board. Horizontal sync pulses (also processed by the video converter IC), Vertical sync pulses (processed by the DAXI buffer IC) and Video blanking pulses (processed by the Player Control μ C) are also applied to the On Screen Display microprocessor. A composite Video signal is output by the video mixer stage which is then applied, via video amp and buffer stages, to the RF modulator.

Video Output

Video Output is provided on the SJT400 Random Access VideoDisc player. The composite video signal is tapped off, just prior to being applied to the RF Modulator stage, and applied to a Video buffer stage. The output of the Video Buffer stage is connected to a video output jack on the rear of the player. This provides a 1V p-p video output signal when terminated with a 75 ohm load.

TURNTABLE HEIGHT ADJUST

To check turntable height—With disc in player in "Play" mode remove AC cord from power source. Remove stylus cartridge and store in safe place. Insert turntable height gauge (see replacement parts list for Stock No.). Hold height gauge in Arm Assembly firmly. Be sure height gauge plunger is free to indicate properly (see illustration).

1. If gauge plunger remains on lowest step—raise turntable height by adjusting height adjust screw (Item 99, Fig. 47) clockwise.
2. If gauge plunger moves to highest step—lower turntable height by adjusting height adjust screw counterclockwise.
3. Proper turntable height—when gauge plunger passes over lowest step on gauge and does **not** pass over highest step.

CAUTION: Use old disc or reserve one side of test disc for this adjustment. DO NOT use a good disc for this procedure.

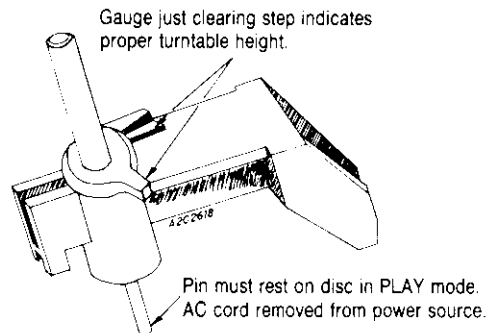

Turntable Height Gauge

Note: Turntable height adjust screw is an Allen head screw accessible from the bottom with a ($1/8$ "") Allen wrench. Some instruments may use a locking screw (same size). First try turning screw clockwise, if screw will not turn with slight pressure the instrument uses a locking screw which must be removed to accomplish turntable height adjust. Replace locking screw when adjustment is complete.

Cabinet Top Removal

1. Place instrument in "off" mode—remove power plug from 120V AC power source.
2. Remove two (2) pozi-drive (+ head) screws Fig. 2.
3. Grasp cabinet top at bottom edge on either side (towards the rear). Pull up and to the rear freeing cabinet top front lip from under the front panel and remove cabinet top.
4. To reassemble—reverse procedure.

Front Panel Removal

1. With cabinet top removed and player in "LOAD" mode—remove AC cord from power source. Use needle nose pliers and carefully remove door push rod spring from front receiver pad (left and right sides) Fig. 9.
2. Grasp front panel along top rear edge—lift rear edge slightly and pull front panel away from player.
3. Remove flex cable plastic cover, disconnect flex cable connector and remove front panel.
4. To reassemble—reverse procedure.

Note: When removing front panel it is necessary that the arm assembly be placed in its forward most position. See stylus cartridge removal for procedure. Be certain, during reassembly that the Flex cable and plastic cover are properly seated.

Bottom Cover Removal

1. If cabinet top has been removed remove receiver spindle assembly (Fig. 14), also remove stylus car-

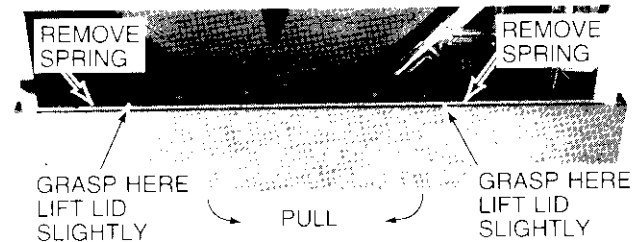

Fig. 9—Door Push Rod Spring

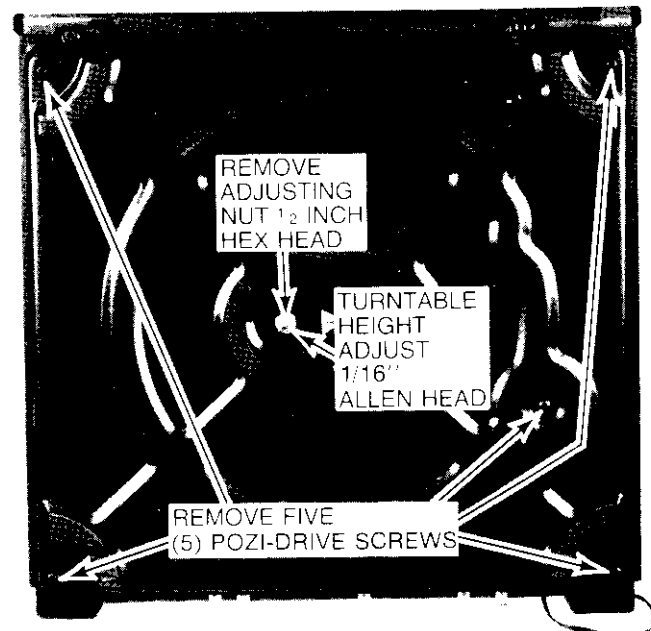

Fig. 10—Bottom Cover

tridge and store in safe place. Place instrument, bottom up, on workbench with soft surface.

2. Remove adjusting nut (1/2 inch Hex Head) and reinforcing plate (1 1/4" washer) from center of bottom cover.
3. Remove five (5) pozi-drive (+ head) screws Fig. 10.
4. To replace—reverse procedure.

Note: When replacing Bottom Cover—just start adjusting nut and screws. Properly seat Bottom Cover then: (a.) tighten screws (b.) tighten adjusting nut.

Master Circuit Board and PW 6100 Removal/Service Position

1. Remove cabinet top and receiver spindle assembly, and stylus cartridge place instrument bottom up on workbench with soft surface. Remove bottom cover.
2. Remove thirteen (13) pozi-drive (+ head) screws Fig. 11.
3. Remove main circuit board and PW 6100 by lifting front edge up to approximately a 10° to 15° angle, so as to clear all obstacles, then move board forward towards front of instrument until antenna connectors clear rear edge of base plate.
4. After circuit boards are clear of baseplate rotate boards horizontally 90° and lay beside instrument.
5. Turn bottom plate over and fasten in position on baseplate with center adjusting nut and reinforcing plate (1 1/4" washer).

Note: Bottom plate must be installed in prescribed manner to operate instrument in service position.

6. Place instrument and circuit board in upright position (Fig. 12), reinstall receiver spindle assembly and if front panel was removed reconnect front panel flex cable to flex cable connector. Instrument is now in operational service position.
7. To reassemble—reverse procedure.

Caution: Replace circuit board mounting screws only in holes from which they were removed (Fig. 11).

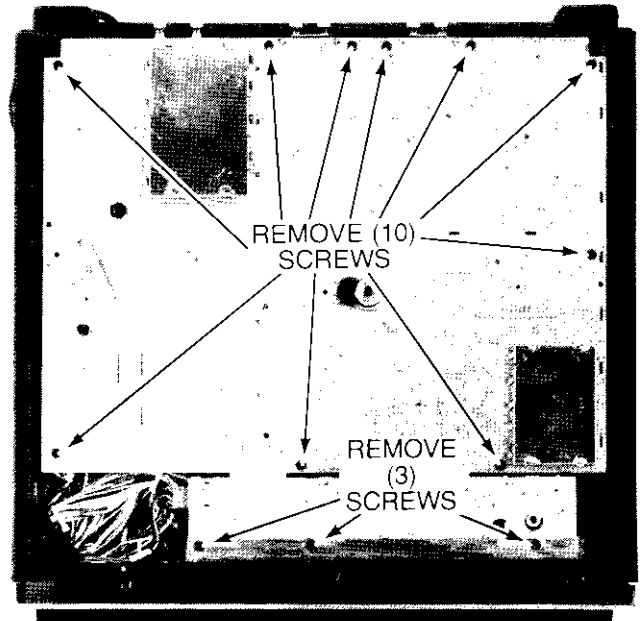

Fig. 11—Master Circuit Board

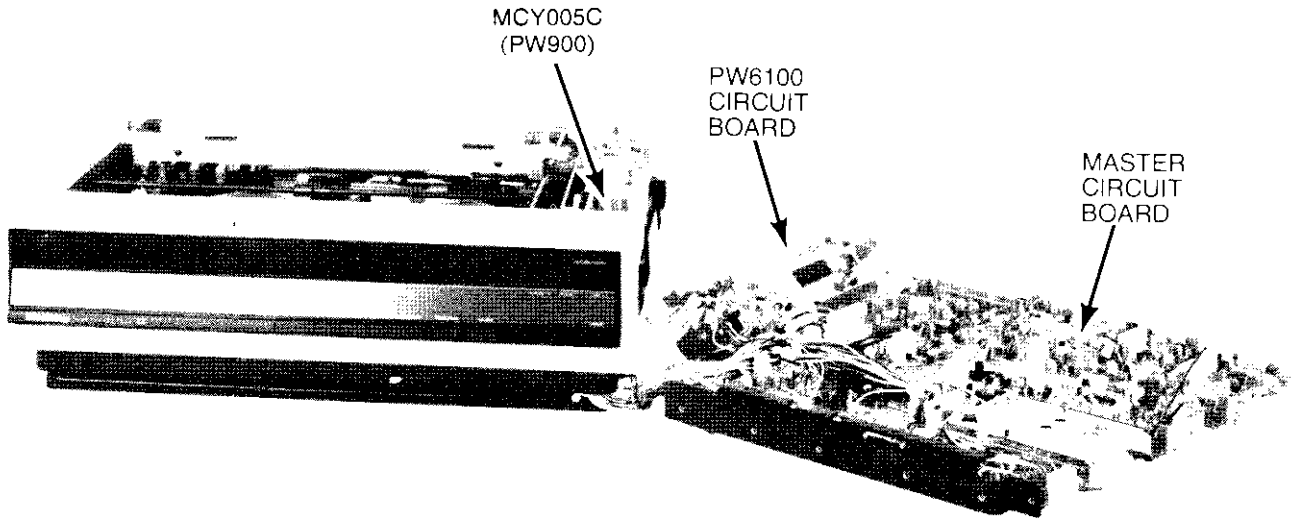

Fig. 12—Service Position

Arm Drive Assembly Disassembly

1. With cabinet top and front panel removed—remove one (1) pozi-drive (+ head) screw Fig. 13.
2. Unsolder and remove Brn. and Wht/Brn wires from radius sense control.
3. Remove stepper motor from arm drive assembly by removing two (2) small pozi-drive (+ head) screws and lay stepper motor to the side out of the way.
4. Move arm drive assembly toward center of player and lift up to remove from player.
5. To replace any gear—first remove wire nut from 3rd reduction gear mounting stud and remove 3rd reduction gear. The 2nd and 1st reduction gears are now accessible.
6. To reassemble—reverse procedure. Be certain ESD ground spring is dressed to the outside of stepper motor mounting screw.

Note: After replacing arm drive assembly—apply power to player. "Load" player with a Video Disc and *rapid access* arm assembly to its *innermost* position. Reject player and unload Video Disc. If a clicking noise is heard during this procedure—disregard—the radius sense control gear is resetting itself. Be certain during this procedure that the arm assembly does indeed reach its innermost and arm home positions.

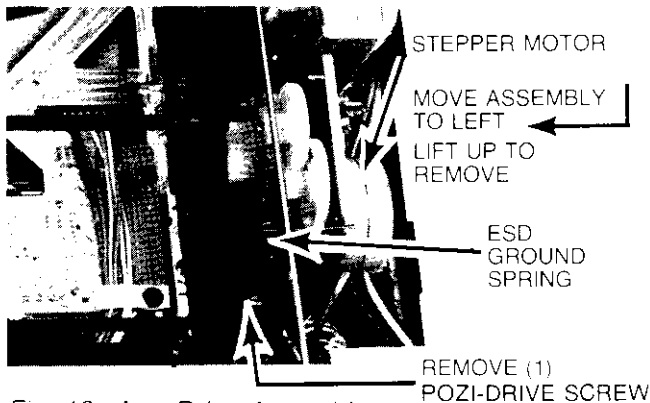

Fig. 13—Arm Drive Assembly

Stylus Cartridge Removal

1. With cabinet top removed—remove AC plug from power source.
2. Using thumb—rotate 2nd reduction gear (Fig. 14) in counter clockwise direction moving the arm assembly to a point where the stylus cartridge access cover (lid) is accessible.
3. Using a small blade screwdriver—unlatch stylus cartridge access cover (lid) latch spring and open access cover (lid).
4. Using thumb and forefinger—grasp stylus cartridge and push it slightly to the right against the arm-stretcher coil assembly. With a rocking motion lift left end of cartridge slightly, then lift cartridge straight up and out of arm assembly.
5. To replace—reverse procedure.

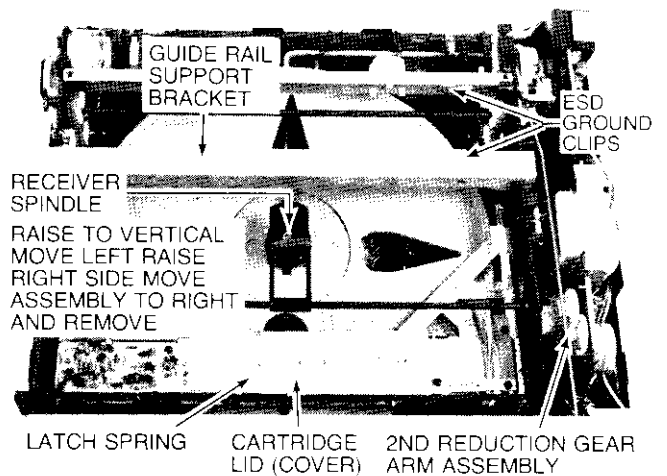

Fig. 14—Stylus Cartridge and Receiver Spindle

Receiver Spindle Assembly Removal

1. With cabinet top removed—rotate receiver spindle assembly to a vertical position (Fig. 14).

Continued next page

2. Move receiver spindle assembly to the left until the right side just clears the right rail assembly.
3. Lift up on right side of receiver spindle assembly until it clears the right rail assembly.
4. Move receiver spindle assembly to the right until it clears the left rail assembly and remove the receiver spindle assembly from the player.
5. To replace—reverse procedure.

Stepper Motor Removal

1. With instrument in service position—remove stepper motor plug, P2, from main circuit board.
2. Cut four (4) wire ties and pull stepper motor cable and plug assembly up through baseplate.
3. Remove two (2) small pozi-drive (+ head) screws used to mount stepper motor and remove stepper motor (Fig. 13).
4. To replace—reverse procedure. Replace wire ties and observe original lead dress.

Function Motor Removal

1. With cabinet top removed—disconnect Blu and Wht/Blu wires from function motor (observe polarity).
2. Remove two (2) posi-drive (+ head) screws and remove gear cover Fig. 16.
3. Remove square drive belt Fig. 16.
4. Remove two (2) small posi-drive (+ head) screws and remove function motor.
5. To replace—reverse procedure.

Note: When replacing Function Motor observe polarity of wiring. Solid blue wire connects to stake beside small plastic stud.

Guide Rail Assembly Removal

1. Place player in "Load" mode and remove AC plug from AC power source. With cabinet top and front panel removed—remove guide rail assembly front support bracket ESD ground spring Fig. 15, and ground clips from guide rail bracket and pivot support brackets (Fig. 14).
2. Remove one (1) small posi-drive (+ head) screw from S2 AC switch shield and remove shield (items 45 & 44, Fig. 47).
3. Remove AC switch, S2, from right rail assembly.
4. Remove AC fuse shield from PW 600 circuit board and mounting bracket assembly.

Note: Removal of PW600 circuit board is not necessary for guide rail assembly removal. However it is recommended for ease and convenience.

5. Unsolder and remove AC input cord from PW600 and remove PW 600 circuit board from bracket assembly. One plastic clip located at the front top edge of mounting bracket holds the circuit board captive. Carefully lift up on this plastic clip and separate circuit board and mounting bracket, then lift straight up on circuit board until it is free of the baseplate. Lay circuit board to right side.
6. Remove PW 600 plastic mounting plate. Use $\frac{1}{4}$ " blade screwdriver through access holes along bottom edge of plate to spring plastic clips holding plate captive to baseplate and lift mounting plate straight up and free of baseplate. Remove switches S7 and S9 from plate assembly.

CAUTION: Switches S7 and S9 are mounted on the plate assembly by molded plastic clips and studs, use special care when removing and replacing switches to avoid breaking them.

7. Grasp mechanism AC switch (S2) off actuator (item 47, Fig. 47) between thumb and forefinger and pull actuator back and free of right rail assembly and function gear (some pressure will be required to perform this step).
8. Using thumb rotate mechanism 2nd reduction and pinion gear in a clockwise direction until the function gear on right rail assembly is engaged. Continue rotating gears until the disc transfer rod coupler (item 38, Fig. 47), mounted on function gear, reaches its top most position. This is the mechanism (player) "off" position.
9. Remove disc transfer rod from coupler and remove coupler from function gear.
10. Remove switches S4 and S8 from left rail assembly and place them out of the way.

CAUTION: Switches S4 and S8 are mounted on the left rail assembly by molded plastic clips and studs, use special care when removing and replacing switches to avoid breaking them.

11. Unsolder function motor leads—observe polarity for replacing.
12. Remove three (3) pozi-drive (+ head) screws (Fig. 15).
13. Lift guide rail assembly to about a 45° angle. Move guide rail assembly toward rear of player unseating one side at a time, and lift straight up to remove from mounting brackets molded into player baseplate. (see Note) Guide rail assembly is now free to be removed from player.

Note: For ease in removal use slight pressure to unseat each side individually, Guide Rail assembly snaps into base plate mountings.

14. To reassemble—reverse procedure.

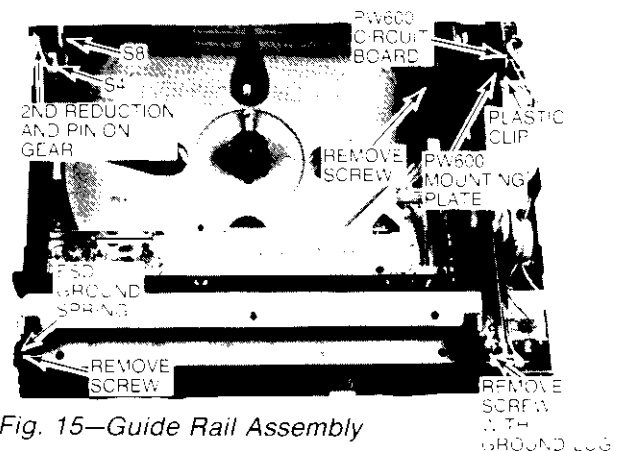

Fig. 15—Guide Rail Assembly

Guide Rail Assembly Disassembly

1. With guide rail assembly removed from player—remove retaining rings from function gear and receiver actuator (Fig. 17).
2. Release front receiver activating rod (Fig. 17) held captive by plastic tab on right rail assembly.
3. Pull both the function gear and receiver actuator away from rail assembly slightly. Push function gear

Continued next page

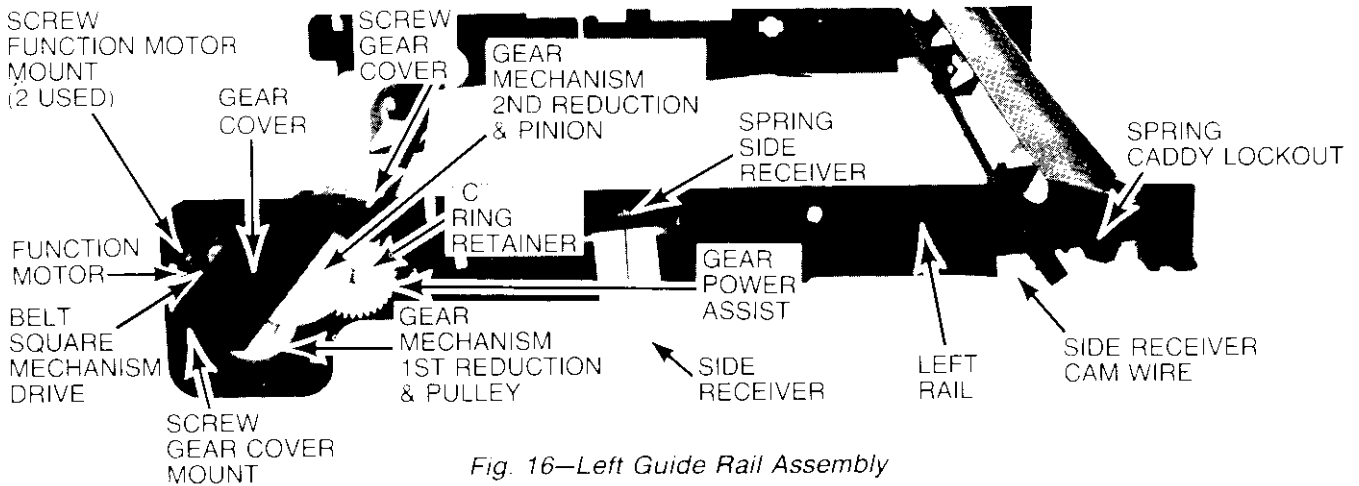

Fig. 16—Left Guide Rail Assembly

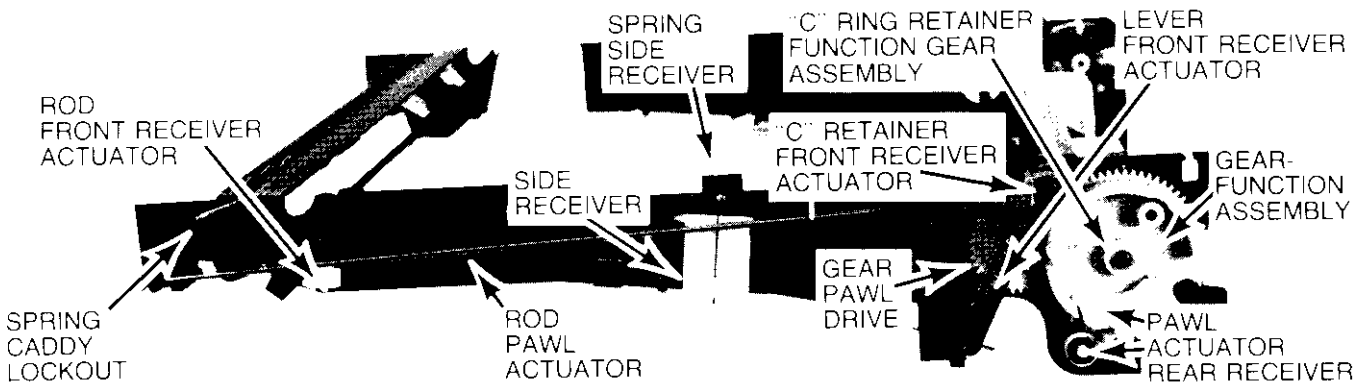

Fig. 17—Right Guide Rail Assembly

pawl out of the way and position function gear to clear receiver actuator. Remove function gear and then the receiver actuator.

Note: Brackets simply snap into place during replacement.

4. Remove side receivers (one each side)—release spring and rotate receiver to 45° angle. Slide receiver toward front of rail assembly and remove from rear mounting bracket by angling rear of receiver away from rail, slide receiver toward rear of rail assembly to complete removal.
5. Remove receiver actuator rod (Fig. 17) from right rail assembly and side receiver wire cam (Fig. 16) from left rail.
6. Remove retaining ring holding pawl drive gear (Fig. 17) captive—remove pawl drive gear.
7. Remove retaining ring holding the power assist gear (Fig. 17) captive. Remove power assist gear.
8. Remove caddy lockout springs (Figs. 16 & 17) right and left sides. Remove caddy lockouts (Figs. 16 & 17).
9. To separate the Left and Right rail assemblies the cabinet support bracket (Fig. 18) and the pivot support bracket (Fig. 18) must be removed.
10. Use small blade screwdriver (approximately 1/8")—slip between plastic overlap of rail assembly and top of cabinet support bracket and pry up to remove bracket. Repeat same procedure at rear of pivot support bracket.

11. Remove spacer (Item 52, Fig. 47) from right rail assembly (holds spine hold down assembly in place on right rail assembly). Remove spine hold down assembly (Item 53, Fig. 47).
12. Remove power assist hub assembly (Item 32, Fig. 47) and front receiver pad assembly (Item 51, Fig. 47).
13. To reassemble—reverse procedure.

CAUTION: Some pressure must be exerted during this procedure, however care must be taken to avoid breaking plastic rail.

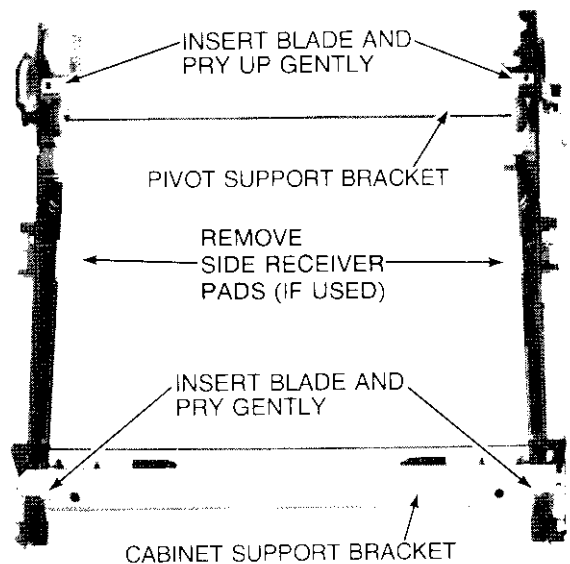

Fig. 18—Guide Rail Assembly

Rear Receiver Pad Assembly Removal

1. With guide rail assembly and turntable removed—release tension on rear receiver pad assembly torsion spring (Fig. 19) and remove wires to switch S8 from wire guide stud. Move switch and wire out of the way.
2. Lift rear receiver pad assembly (Fig. 19) straight up and remove from baseplate.
3. To replace—reverse procedure.

Note: Before replacing rear receiver pad assembly in position apply one (1) full turn of tension to torsion spring.

Caddy Defeat and Spine Latch Assembly Removal

1. With guide rail assembly removed—release caddy defeat springs (Fig. 19) from baseplate studs.
2. Remove spacer clip (Fig. 19) from caddy defeat and spine latch assembly.
3. Slide caddy defeat and spine latch assembly (Fig. 19) to right—raise left side of assembly to clear mounting stud and slide assembly to left to remove.
4. To replace—reverse procedure.

Disc Transfer Rod Removal

1. With Guide Rail, Rear Receiver Pad and Caddy Defeat/Spine Latch assemblies removed—release Transfer Rod spring (Fig. 19) from baseplate stud.
2. Rotate Transfer Rod (Fig. 19) upward to clear center portion of baseplate.
3. Move Transfer Rod to the left to clear far right mounting stud. Rotate rod toward rear of player to clear next mounting stud and continue moving rod to the left.
4. After the first large mounting stud has been cleared by transfer rod, guide left portion of rod up and toward rear of player. Drop right portion of rod into trough molded into baseplate.
5. Using an upward arcing motion continue moving rod until it can easily be lifted up and out of the center baseplate mounting studs.

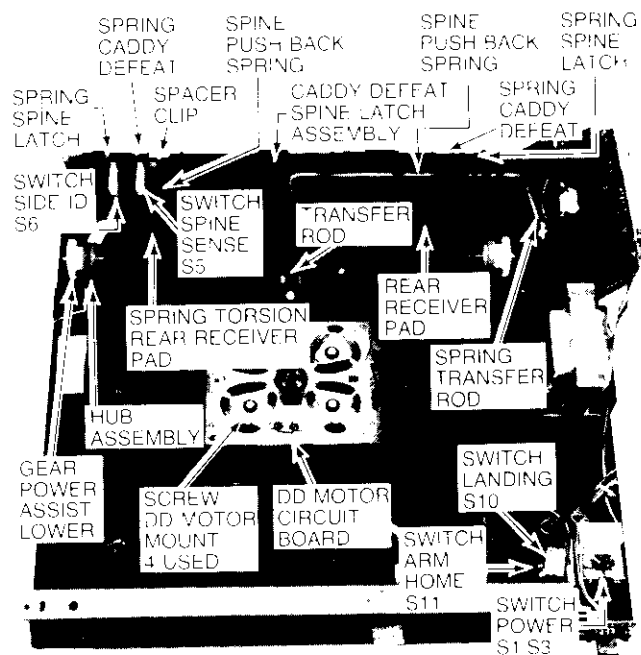

Fig. 19—Miscellaneous Disassembly

6. To replace—reverse procedure.

Note: No force is required to remove or replace the disc Transfer Rod.

Turntable Removal

1. With cabinet top, receiver spindle assembly and guide rail bracket removed—use thumb to rotate mechanism drive 2nd reduction gear (Fig. 16) in clockwise direction to place mechanism in "PLAY" mode while holding AC switch (S2) actuator (Item 47, Fig. 47) back out of the way. Immediately stop rotating mechanism 2nd reduction gear when Disc Transfer Rod Coupler (Item 38, Fig. 47) activates "PLAY" Switch S7 (forwardmost switch mounted on plastic AC IN board mounting bracket beside mechanism function gear).
2. Rotate turntable to center solid portion of turntable over transfer rod (two holes in turn-table at 45° angle with respect to rear edge of player).
3. Lift up on turntable and angle front edge of turntable to clear front receiver pad and remove turntable from player on an angle.
4. To replace—reverse procedure.

Note: When replacing turntable—be certain to check magnet and turntable well for debris.

CAUTION: There is a thrust plate (Item 102, Fig. 47) used in the turntable bearing. Be sure that it is in place before replacing turntable. Do not turn player upside down during servicing without turntable in place, it could result in possible loss of the thrust plate.

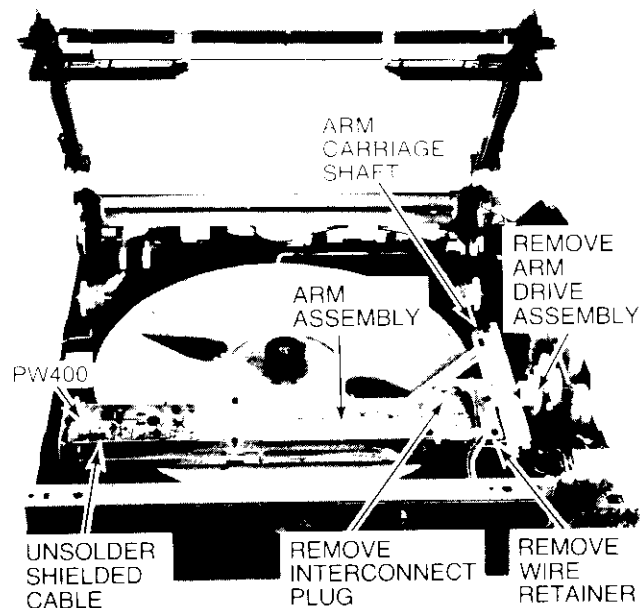

Fig. 20—Turntable and Arm Assembly

Arm Assembly Removal

1. With cabinet top, cabinet front and receiver spindle removed—remove cabinet support bracket ESD ground spring from left front corner.
2. Remove ground clips from guide rail bracket and pivot support bracket. Remove stylus cartridge from arm assembly and store in safe place.
3. Remove Arm Drive Assembly from baseplate and move to the side out of the way.
4. Remove three (3) pozi-drive (+ head) screws holding

Continued on next page

guide rail assembly and lift assembly to 45° angle. (Fig. 20).

5. Unsolder shielded AO cable from PW 400, arm preamp circuit board. Remove cable strap and P 101 from arm interconnect circuit board.
6. Lift Arm Carriage Shaft (Fig. 20) from its rear baseplate mounting and pull it loose from its front baseplate mounting.
7. Remove Arm assembly from player.
8. To replace—reverse procedure.

PW 200 Resonator Removal

1. Remove stylus cartridge and store in safe place.
2. Remove two (2) pozi-drive (+ head) screws holding resonator captive and remove stylus cover latch spring (Fig. 21).
3. Unsolder three (3) wires connected to feed-thru studs on resonator.
4. Lift resonator up to remove from Arm Assembly.
5. To replace—reverse procedure.

Lifter Actuator Assembly Removal

1. Remove cartridge cover and stylus cartridge. Place stylus cartridge in safe place.
2. Remove two (2) lifter pivot retaining clips—one (1) each side of arm assembly (Fig. 21).
3. Remove Lifter Actuator assembly.

4. To replace—reverse procedure.

Note: See *Stylus Lifter Alignment* page 69.

Armstretcher Coil Removal

1. Remove arm assembly from player and place on solid flat surface.
2. With Lifter Actuator removed — unsolder leads from Armstretcher Coil (observe polarity).
3. Break push on retainers and remove Armstretcher coil.
4. To replace, reverse procedure (new push on retainers required).

Note: See Arm Assembly schematic for Armstretcher Coil basing.

Kicker Coil Replacement

1. Remove arm assembly from player and place on solid flat surface.
2. With Lifter Actuator removed — unsolder leads from Kicker Coil (observe polarity).
3. Break push on retainers and remove kicker coil assembly.
4. To replace, reverse procedure (new push on retainers required).

Note: See Arm assembly schematic for Kicker Coil basing.

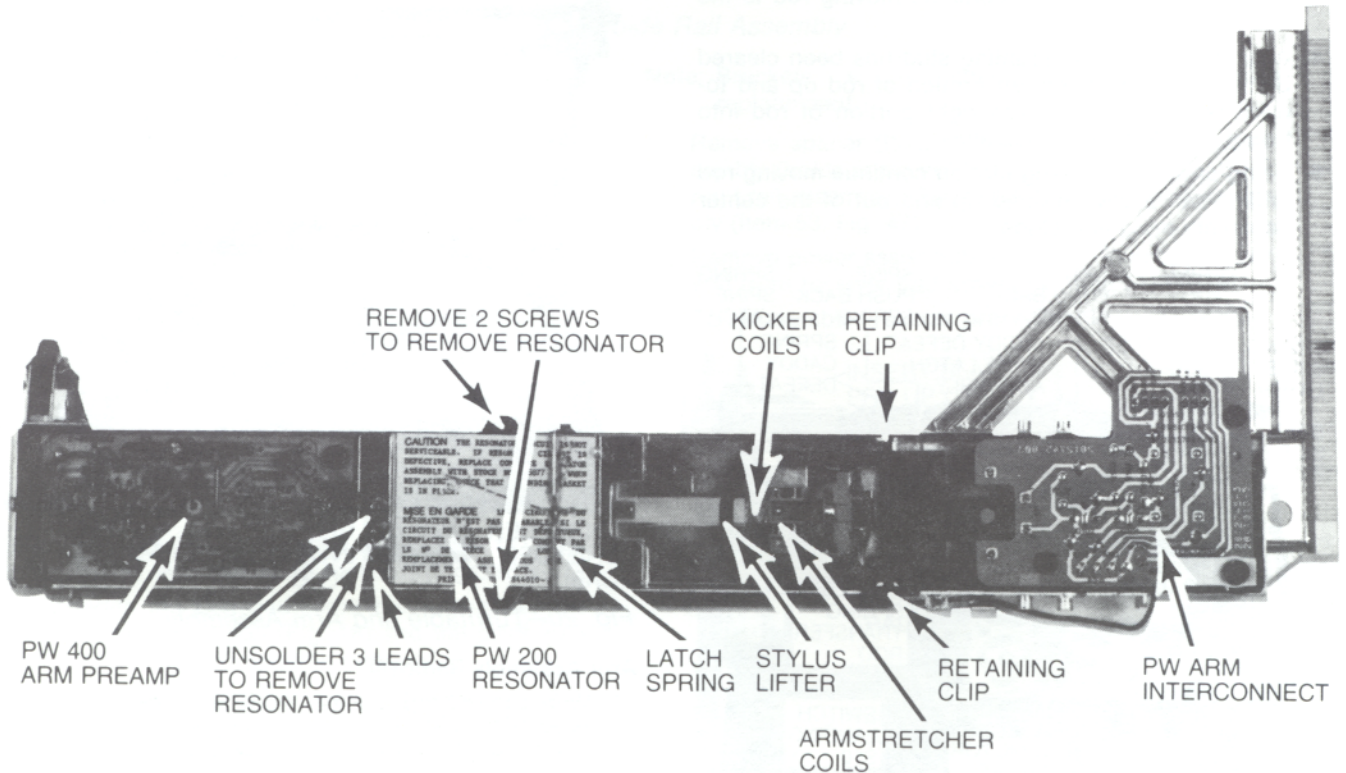

Fig. 21—Arm Assembly

Test Equipment Required:**Digital Voltmeter****Oscilloscope****Frequency Counter****VideoDisc****Color TV Receiver****Marker Generator****Alignment Tools****Specifications**Range: .1V DC to 30V DC
Accuracy: $\pm 1\%$ Triggered
Response: DC – 20 MHz.
Sensitivity: 5mV/cm
Maximum Sweep Rate .1 μ S/cmRange: 50 Hz to 100 MHz.
Sensitivity: 25mV to 5V

Stereo Alignment Disc: See Replacement Parts List for Stock No.

Standard NTSC

Range: Crystal Calibrated from 19 to 262 MHz.

2.5mm non-metallic female
Hex Head adjustment tool
(see replacement parts list for Stock No.)
.056" square end tool GC9440 or equivalent
.100" hex end tool GC8606 or equivalent
insulated blade tool GC8722 or equivalent**ELECTRICAL ADJUSTMENTS****Note:** Use only the Stereo Alignment (TEST) Disc (see replacement parts list for stock no.) to perform the following adjustments.**5V Reference Adjust (R2020)**

1. Apply power to player and place in "Load" mode.
2. Connect DC Voltmeter to TP 2003 (Fig. 26).
3. Adjust R2020 for 5.0V DC \pm .05V DC (Fig. 28).

3.58 MHz Reference Oscillator Adjust (C5902)

1. Connect frequency counter via X10 probe (see note) to TP 3406 (Fig. 26).
2. With player in "Load" mode adjust C5902 for 3.579545 \pm 10 Hz (Fig. 27).

Note: Typical capacity of X10 probe and counter is approximately 20-25pf. A X1 probe (typical capacity of approximately 100pf) may be used with a 33pf capacitor placed in series with probe.**NLAC (DC Balance) Adjust (R3131)**

1. Place player in "Pause" mode.
2. Connect DC Voltmeter to TP 3101 (Fig. 26).
3. Adjust R3131 to produce a 10.5 \pm 0.5 V.D.C. reading (Fig. 28).

Video Demodulator VCO Adjust (C3215)

1. Apply power to player.
2. Disconnect interconnect plug P4 (A0).
3. Short the two pins of J4 together.
4. Connect frequency counter via X10 probe (see note) to TP 3102 (Fig. 26).
5. Adjust C3215 for 5.25 MHz \pm 50 KHz (Fig. 28).
6. Remove short from the two pins of J4 and reconnect P4.

Note: Typical capacity of X10 probe and counter is approximately 20-25pf. A X1 probe (typical capacity of 100 pf) may be used with a 33pf capacitor placed in series with probe. This will place a load on the VCO of approximately 25pf.**Video Level Adjust (R3202)**

1. Place player in "Play" mode.
2. Use stereo alignment disc 100 IRE white field signal (Segment E).
3. Connect oscilloscope to TP 3410 (Fig. 26).
4. Adjust R3202 (video level adjust) to produce 2.8Vp-p response at TP 3410 (Fig. 28).

Luminance Channel Null Adjust (R3328)

1. Place player in "Play" mode.
2. Use stereo alignment disc color bar signal (Segment D).
3. Connect oscilloscope to TP 3302 (Fig. 26).
4. Adjust R3328 for minimum (null) chroma information. See Figs. 22 & 28.

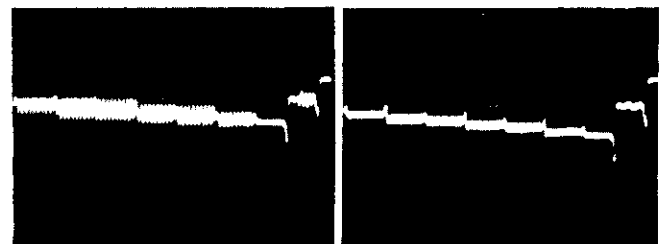

INCORRECT

CORRECT

Fig. 22—Luminance Null

Chroma Channel Null Adjust (R3329)

1. Place player in "Play" mode.
2. Use stereo alignment disc color bar signal (Segment D).
3. Connect oscilloscope to TP 3303 (Fig. 26).
4. Adjust R3329 for minimum p-p signal see Figs. 23 & 28.

Note: Repeat Video Level Adjustment after completion of Luminance Channel Null and Chroma Channel Null adjustments.

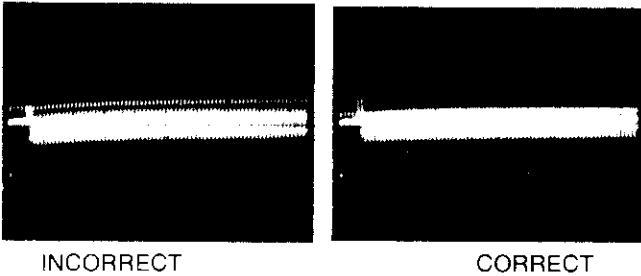

Fig. 23—Chroma Null

Vertical Detail Level Adjust (R3317)

1. Place player in "Play" mode.
2. Use stereo alignment disc color bar signal (Segment D).
3. Connect oscilloscope to TP 3404 (Fig. 26).
4. Adjust R3317 so that the pulse level matches before and after transition from vertical equalizing pulses to vertical sync pulses see Figs. 24 & 28.

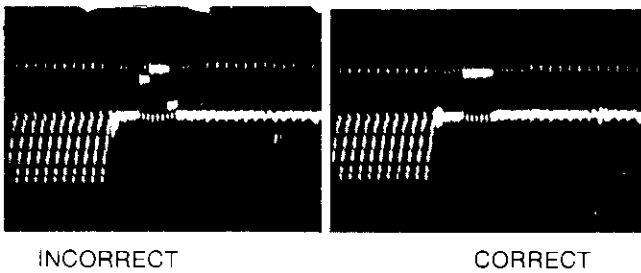

Fig. 24—Vertical Detail Level

Chroma Level Adjust (R3312)

1. Place player in "Play" mode.
2. Use stereo alignment disc color bar signal (Segment D).
3. Connect oscilloscope to TP 3410 (Fig. 26).
4. Adjust R3312 so that the p-p level of color reference burst is 1V p-p see Figs. 25 & 28.

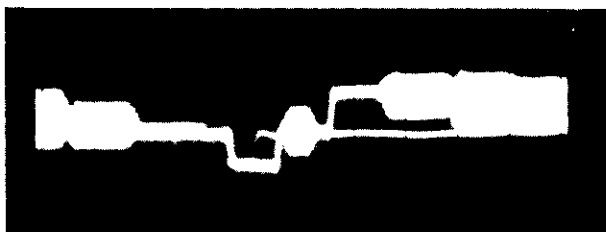

Fig. 25—Chroma Level

Defect Substitution Level (Delayed Video) Adjust (R3304)

1. Place player in "Play" mode.
2. Use stereo alignment disc 5 step linearity with defect (Segment I).
3. Connect disc player to TV set. Locate defect (Line No. 130) by rotating R3304 to one end of rotation (Fig. 28).
4. Adjust R3304 for proper substitution to make defect disappear (adjust for best picture).

VCXO Adjust

1. Place player in "Pause" mode.
2. Apply +5V to U3402 Pin 1.
3. Connect DVM from TP 3402 to ground (Fig. 26).
4. Connect 4.7 MΩ resistor from TP 3412 (U3401 Pin 6) to +15V DC source and record voltage V1 measured on DVM at TP 3402 (Fig. 26).
5. Remove 4.7 MΩ resistor end from +15V source and connect it to ground.
6. Record voltage measured on DVM as V2. Remove grounded end of 4.7 MΩ resistor, leave one end connected to TP 3412 (Fig. 26).
7. Using the formula $\Delta F = 3/2 (V1 - V2 - .177)$ kHz, calculate ΔF. (The result should be between 1.90 and 2.52 kHz.)

Example: $\Delta F = 3/2 (8.66V - 7.09V - .177)$ kHz
 $\Delta F = 3/2 (1.393)$ kHz
 $\Delta F = 1.5 \times 1.393$ kHz
 $\Delta F = 2.09$ kHz

Note: The voltages shown in solving the formula to determine ΔF are example voltages — actual measured voltages (V1 & V2) will have to be substituted.

8. Calculate high frequency limit fH = 1535.625 + ΔF kHz

Example: fH = 1535.625 kHz + 2.09 kHz

9. Calculate low frequency limit. fL = 1535.625 - ΔF kHz

Example: fL = 1535.625 kHz - 2.09 kHz

10. Connect frequency counter via X10 probe to TP 3407.

Note: Typical capacity of X10 probe is approximately 20-25 pf. A X1 probe (typical capacity of approximately 100 pf) may be used with a 33 pf capacitor if placed in series with probe.

11. Remove +5V from U3402 Pin 1.
12. Adjust L3403 for 1.534091 ± 100 Hz (Fig. 28).

CAUTION: 4.7 MΩ resistor must be open at one end to make this adjustment.

13. Connect 4.7 MΩ resistor from TP 3412 to +15V source. With player in "Play" mode, release pause mode. Frequency indicated on frequency meter should be ±100 Hz of previously calculated fH (EXAMPLE: 1537.715 kHz ± 100 Hz). If not, adjust R3412 to achieve the previously calculated fH.

14. Remove 4.7 MΩ resistor from +15V source and place player in "Pause" mode. Check that frequency on fre-

Continued next page

quency meter is 1.534091 ± 100 Hz. If not, adjust L3403.

15. Connect 4.7 M Ω resistor from TP 3412 to ground. With player in "Play" mode, release "Pause" mode. Frequency indicated on frequency counter should be ± 100 Hz of previously calculated fL (Example: 1533.445 kHz ± 100 Hz). If not, adjust L3402 to remove approximately 1/2 of the frequency error and adjust R3412 to remove the remainder.
16. Repeat Steps 13-16 until limits of each are met.
17. Remove 4.7 M Ω resistor from TP 3412.

Phase Detector Gain Adjust (R3419)

1. Use stereo alignment disc—any signal, place player in "Play" mode.
2. Connect oscilloscope to TP 3408 (Fig. 26).
3. Short TP 3401 to TP 3403 with a clip lead. Short TP 3402 to TP 3403 with a clip lead.
4. Adjust R3419 for 3V p-p waveform at TP 3408 (Fig. 28).
5. Remove shorting clip leads from TP 3401 and TP 3402 to TP 3403.

Audio Demodulator VCO Adjust (716 kHz) (R4111)

1. Place player in "Load" mode.
2. Disconnect interconnect plug P4 (AO).
3. Short the two pins of J4 together.
4. Connect frequency counter via X10 probe (see note) to TP 4008 (Fig. 26).
5. Adjust R4111 for 716 kHz ± 2 kHz (Fig. 28).
6. Remove frequency counter and remove short from the two pins of J4. Reconnect P4.

Note: Typical capacity of X10 probe and counter is approximately 20-25 pf. A X1 probe (typical capacity of approximately 100 pf) may be used with a 33 pf capacitor placed in series with probe. This will place a load on the VCO of approximately 25 pf.

Audio Demodulator VCO Adjust (905 kHz) (R4112)

1. Place player in "Load" mode.
2. Disconnect interconnect plug P4 (AO).
3. Short the two pins of J4 together.
4. Connect frequency counter via X10 probe (see note) to TP 4009 (Fig. 26).
5. Adjust R4112 for 905 kHz ± 2 kHz (Fig. 28).
6. Remove frequency counter and remove short from the two pins of J4. Reconnect P4.

Note: Typical capacity of X10 probe and counter is approximately 20-25 pf. A X1 probe (typical capacity of approximately 100 pf) may be used with a 33 pf capacitor placed in series with probe. This will place a load on the VCO of approximately 25 pf.

(L + R) Level Adjust (R4127)

1. Place player in "Play" mode.
2. Connect oscilloscope to J4602 (R OUT) Fig. 26.
3. Ground TP 5102.

4. Use stereo alignment disc Segment G (S1: 1020 Hz 50% S2: 1020 Hz 50% out of phase)
5. Adjust R4127 (Fig. 28) to produce 560 \pm 20 mV p-p; audio signal at J4602 (R OUT).
6. Remove ground from TP 5102.

(L-R) Level Adjust (R4128)

1. Place player in "Play" mode.
2. Connect oscilloscope to J4602 (R OUT) (Fig. 26).
3. Use stereo alignment disc Segment G. (S1: 1020 Hz 50% S2: 1020 Hz 50% out of phase).
4. Adjust R4128 (Fig. 28) to produce a minimum (null) V p-p at J4602 (R OUT).

TV Audio Level Adjust (R4303)

1. Place player in "Play" mode.
2. Use stereo alignment disc Segment C (S1: 1020 Hz 100%).
3. Connect oscilloscope to TP 3504 (Fig. 26).
4. Adjust R4303 (Fig. 28) to produce 1.2V p-p audio signal at TP 3504.

R. F. Output Channel Oscillator Adjust (L3501, L3502)

1. With player in "Load" mode, place Channel Switch, S3501, in Channel 3 position. Connect player to TV or 75 ohm load.
2. Connect marker generator (RF input) to TP 3501 and adjust for 61.25 MHz output, Fig. 26.
3. Adjust L3501 for zero beat (Fig. 28).
4. Place Channel Switch, S3501, in Channel 4 position.
5. Connect marker generator (RF input) to TP 3503 and adjust for 67.25 MHz output.
6. Adjust L3502 for zero beat (Fig. 28).

Note: Do not adjust RF Bandpass Coils L3506 and L3507.

4.5 MHz Oscillator Adjust (L3509)

1. Connect player to TV, player in "Load" mode.
2. Monitor a suitable point in TV IF to pick up 4.5 MHz sound carrier with a frequency counter.
3. Adjust L3509 (Fig. 28) for 4.5 MHz ± 1 kHz.

Video Modulation Depth Adjust (R3402)

1. Connect player to TV, player in "Play" mode.
2. Use stereo alignment disc 120 IRE white field signal (Segment H).
3. Adjust R3402 (Fig. 28) clockwise till a buzz is heard in TV audio, then turn counterclockwise to just eliminate the buzz.

Audio Modulation Depth Adjust (R4303)

1. Place player in "Play" mode.
2. Use stereo alignment disc, uniform motion on grey field, S1: 1020 Hz 100% (Segment C).
3. Connect oscilloscope to TP 3504 Fig. 26.
4. Adjust R4303 (Fig. 28) for 1.2 V p-p at TP 3504.

NOTE: The feature board adjustments are factory preset and should require no further adjustments. However, if adjustment is deemed necessary the following procedure is recommended.

Features Board Adjustment 1MHz, 6MHz and Sync Tip

1. Remove J6104 interconnect plug and cable from master circuit board.
2. Place instrument in "Pause" mode.
3. Varyify -4.5VDC at pin 10 of U 6103, OSD μ P.
4. Adjust L6101 (1MHz adjust) for 2.2VDC \pm 0.5VDC at TP 6106.
5. Adjust L6102 (6MHz adjust) for 8.0VDC \pm 0.2VDC at TP 6107.
6. Connect dual trace oscilloscope to J6104-1 and J6104-5.
7. Apply +5.0VDC \pm .05VDC to J6104-1.
8. Adjust R6169 (Sync Tip Adjust) until sync tip levels at J6104-1 and J6104-5 are the same level (\pm 0.05VDC).
9. Remove oscilloscope and reconnect J6104 to Master Circuit Board. The word "PAUSE" will appear on screen.

I C VOLTAGE CHARTS

U5101 Player Control μ C

Pin No.	Load	Play	Pause	Unload
1	GND	GND	GND	GND
2	+2.39V	+2.39V	+2.39V	+2.39V
3	+4.86V	+4.86V	+4.86V	+4.86V
4	+4.88V	+4.56V	0V	0V
5	N.C.	N.C.	N.C.	N.C.
6	N.C.	N.C.	N.C.	N.C.
7	+4.81V	+4.81V	+4.81V	+4.81V
8	+4.88V	+4.88V	+4.88V	+4.88V
9	+0.06V	+4.93V	+0.06V	+0.06V
10	+0.06V	+4.93V	+0.06V	+0.06V
11	+4.66V	+4.66V	+4.66V	+4.66V
12	+0.72V	+0.09V	+0.72V	+0.72V
13	See Note 1	See Note 1	See Note 1	See Note 1
14	See Note 1	See Note 1	See Note 1	See Note 1
15	See Note 1	See Note 1	See Note 1	See Note 1
16	See Note 1	See Note 1	See Note 1	See Note 1
17	See Note 1	See Note 1	See Note 1	See Note 1
18	See Note 1	See Note 1	See Note 1	See Note 1
19	See Note 1	See Note 1	See Note 1	See Note 1
20	See Note 4	See Note 4	See Note 4	See Note 4
21	Gnd	Gnd	Gnd	Gnd
22	See Note 4	See Note 4	See Note 4	See Note 4
23	See Note 4	See Note 4	See Note 4	See Note 4
24	See Note 4	See Note 4	See Note 4	See Note 4
25	+4.81V	+4.81V	+4.81V	+4.81V
26	See Note 2	See Note 2	See Note 2	See Note 2
27	See Note 2	See Note 2	See Note 2	See Note 2
28	0V	+4.89V	0V	0V
29	0V	+4.85V	+4.85V	+4.85V
30	See Note 4	See Note 4	See Note 4	See Note 4
31	+0.10V	+0.10V	+0.10V	+0.10V
32	+4.83V	+0.10V	+0.10V	+4.83V
33	0V	+4.84V	+4.84V	+4.84V
34	+0.70V	+0.70V	+0.70V	+0.70V
35	+3.55V	+3.55V	+3.55V	+3.55V
36	0V	+4.87V	+4.87V	+4.87V
37	+4.87V	See Note 3	+4.87V	+4.87V
38	+4.76V	See Note 3	+4.76V	+4.76V
39	+4.76V	See Note 3	+4.76V	+4.76V
40	+4.76V	See Note 3	+4.76V	+4.76V
41	+4.76V	See Note 3	+4.76V	+4.76V
42	+4.87V	+4.87V	+4.87V	+4.87V

N.C.—No Connection

Note 1. Voltage variable—depending upon which element of digital display is illuminated.

U 5102 Daxi Buffer μ P

Pin No.	Load	Play	Pause	Unload
1	+2.69V	+2.69V	+2.69V	+2.69V
2	N.C.	N.C.	N.C.	N.C.
3	+2.59V	+2.59V	+2.59V	+2.59V
4	+4.81V	+0.35V	+4.81V	+4.81V
5	See Note 4	See Note 4	See Note 4	See Note 4
6	+2.39V	+2.39V	+2.39V	+2.39V
7	Gnd	Gnd	Gnd	Gnd
8	0V	+0.10V	0V	0V
9	N.C.	N.C.	N.C.	N.C.
10	See Note 4	See Note 4	See Note 4	See Note 4
11	See Note 4	See Note 4	See Note 4	See Note 4
12	N.C.	N.C.	N.C.	N.C.
13	0V	+0.10V	0V	0V
14	+4.95V	+4.95V	+4.95V	+4.95V

U5901 Mechanism Control μ C

Pin No.	Load	Play	Pause	Unload
1	+2.15V	+2.15V	+2.15V	+2.15V
2	+2.58V	+2.58V	+2.58V	+2.58V
3	+4.87V	+4.87V	+4.87V	+4.87V
4	+4.90V	See Note 4	See Note 4	See Note 4
5	+4.90V	See Note 5	See Note 5	See Note 5
6	+0.70V	+0.70V	+0.70V	+0.70V
7	+0.70V	+0.70V	+0.70V	+0.70V
8	+4.84V	+4.68V	+4.68V	+4.84V
9	+4.84V	+4.68V	+4.68V	+4.84V
10	+4.84V	+4.68V	+4.68V	+4.84V
11	+4.84V	+4.68V	+4.68V	+4.84V
12	0V	+4.84V	+4.84V	+4.84V
13	N.C.	N.C.	N.C.	N.C.
14	Gnd	Gnd	Gnd	Gnd
15	N.C.	N.C.	N.C.	N.C.
16	N.C.	N.C.	N.C.	N.C.
17	+4.84V	+0.10V	+0.10V	+4.84V
18	+0.10V	+0.10V	+0.10V	+0.10V

N.C.—No Connection

Note 2. Voltage variable stepper motor control pulses.

Note 3. Voltage controlled by front panel function switches (5600 series). Normally high—momentary low when corresponding function switch is depressed.

U5901 Mechanism Control μ C (continued)

Pin No.	Load	Play	Pause	Unload
19	+4.84V	+4.84V	+4.84V	+4.84V
20	+4.84V	+4.84V	+4.84V	+4.84V
21	+0.10V	+2.50V	+2.50V	+0.10V
22	+0.10V	+2.50V	+2.50V	+0.10V
23	0V	+4.85V	+4.85V	+4.85V
24	+4.78V	+4.87V	+4.78V	+4.78V
25	+4.78V	0V	0V	0V
26	+4.89V	+4.89V	+4.89V	+4.89V
27	See Note 5	See Note 5	See Note 5	See Note 5
28	+4.89V	+4.89V	+4.89V	+4.89V

U5902 T.T. Motor Control I.C.

Pin No.	Load	Play	Pause	Unload
1	+0.26V	+0.34V	+0.34V	+0.26V
2	+0.58V	+0.58V	+0.58V	+0.58V
3	+0.58V	+0.58V	+0.58V	+0.58V
4	+4.89V	+4.89V	+4.89V	+4.89V
5	+0.58V	+0.58V	+0.58V	+0.58V
6	+0.58V	+0.58V	+0.58V	+0.58V
7	+0.24V	+0.32V	+0.32V	+0.24V
8	+0.24V	+0.32V	+0.32V	+0.24V
9	+0.58V	+0.58V	+0.58V	+0.58V
10	+0.58V	+0.58V	+0.58V	+0.58V
11	Gnd	Gnd	Gnd	Gnd
12	+0.58V	+0.58V	+0.58V	+0.58V
13	+0.58V	+0.58V	+0.58V	+0.58V
14	+0.26V	+0.34V	+0.34V	+0.26V

U2001 Power Supply IC

Pin No.	Load	Play	Pause	Unload
1	+5.15V	—	—	—
2	+0.89V	—	—	—
3	+0.89V	—	—	—
4	+22.4V	—	—	—
5	+4.90V	—	—	—
6	+4.90V	—	—	—
7	+12.8V	—	—	—
8	+3.18V	—	—	—
9	+4.90V	—	—	—
10	+4.90V	—	—	—
11	Gnd	—	—	—
12	+4.90V	—	—	—
13	+4.90V	—	—	—
14	+11.5V	—	—	—

U2501 Pulse Interference Corrector (PIC) IC

Pin No.	Load	Play	Pause	Unload
1	+5.40V	+6.87V	+6.87V	+5.40V
2	+3.64V	+3.64V	+3.64V	+3.64V
3	N.C.	N.C.	N.C.	N.C.

U2501 Pulse Interference Corrector (PIC) IC (continued)

Pin No.	Load	Play	Pause	Unload
4	+1.47V	+1.47V	+1.47V	+1.47V
5	+1.47V	+1.47V	+1.47V	+1.47V
6	+1.47V	+1.47V	+1.47V	+1.47V
7	Gnd	Gnd	Gnd	Gnd
8	Gnd	Gnd	Gnd	Gnd
9	N.C.	N.C.	N.C.	N.C.
10	N.C.	N.C.	N.C.	N.C.
11	N.C.	N.C.	N.C.	N.C.
12	+3.64V	+3.64V	+3.64V	+3.64V
13	+11.6V	+11.6V	+11.6V	+11.6V
14	+6.15V	+7.57V	+7.57V	+6.15V

U3101 Sync Detector IC (NLAC)

Pin No.	Load	Play	Pause	Unload
1	+4.69V	+4.77V	+4.69V	+4.69V
2	+3.53V	+3.47V	+3.47V	+3.47V
3	Gnd	Gnd	Gnd	Gnd
4	+1.42V	+1.42V	+1.42V	+1.42V
5	+1.42V	+1.42V	+1.42V	+1.42V
6	+1.42V	+1.42V	+1.42V	+1.42V
7	Gnd	Gnd	Gnd	Gnd
8	Gnd	Gnd	Gnd	Gnd
9	N.C.	N.C.	N.C.	N.C.
10	N.C.	N.C.	N.C.	N.C.
11	N.C.	N.C.	N.C.	N.C.
12	+3.53V	+3.47V	+3.47V	+3.47V
13	+10.3V	+10.3V	+10.3V	+10.3V
14	+5.36V	+5.36V	+5.36V	+5.36V

U3201 Video FM Demod IC

Pin No.	Load	Play	Pause	Unload
1	+3.10V	+3.10V	+3.10V	+3.10V
2	+3.10V	+3.10V	+3.10V	+3.10V
3	+3.10V	+3.10V	+3.10V	+3.10V
4	Gnd	Gnd	Gnd	Gnd
5	+6.90V	+6.98V	+6.98V	+6.90V
6	+6.90V	+6.84V	+6.84V	+6.90V
7	+6.24V	+6.32V	+6.32V	+6.24V
8	+0.45V	+4.19V	+1.16V	+0.45V
9	+5.60V	+5.87V	+5.60V	+5.60V
10	+2.10V	0V	0V	+2.10V
11	+5.90V	+6.20V	+5.90V	+5.90V
12	0V	+4.17V	+1.15V	0V
13	+5.75V	+5.82V	+5.82V	+5.75V
14	+11.5V	+11.5V	+11.5V	+11.5V
15	+5.24V	+5.30V	+5.30V	+5.24V
16	+5.24V	+5.30V	+5.30V	+5.24V

Note 5. Voltage dependent on side of disc being played. Side 1 play—voltage high; side 2 play—voltage low

U3301 ComB Filter/Defect Corrector IC

Pin No.	Load	Play	Pause	Unload
1	+5.05V	+5.05V	+5.05V	+5.05V
2	+5.74V	+5.83V	+5.83V	+5.74V
3	-4.52V	-4.52V	-4.52V	-4.52V
4	+3.89V	+3.89V	+3.89V	+3.89V
5	-4.52V	-4.52V	-4.52V	-4.52V
6	-4.52V	-4.52V	-4.52V	-4.52V
7	-4.52V	-4.52V	-4.52V	-4.52V
8	Gnd	Gnd	Gnd	Gnd
9	+8.86V	+8.86V	+8.86V	+8.86V
10	+3.86V	+3.86V	+3.86V	+3.86V
11	+3.73V	+3.73V	+3.73V	+3.73V
12	+2.57V	+2.57V	+2.57V	+2.57V
13	+2.42V	+2.42V	+2.42V	+2.42V
14	+5.32V	+5.32V	+5.32V	+5.32V
15	+5.18V	+5.18V	+5.18V	+5.18V
16	+14.6V	+14.6V	+14.6V	+14.6V
17	N.C.	N.C.	N.C.	N.C.
18	+5.10V	+5.10V	+5.10V	+5.10V
19	+4.76V	+4.76V	+4.76V	+4.76V
20	+8.50V	+8.50V	+8.50V	+8.50V
21	+7.24V	+7.24V	+7.24V	+7.24V
22	+5.25V	+5.25V	+5.25V	+5.25V

U3401 Armstretcher IC

Pin No.	Load	Play	Pause	Unload
1	+7.97V	+7.97V	+7.24V	+7.97V
2	+7.23V	+7.23V	+7.23V	+7.23V
3	+5.74V	+5.74V	+5.74V	+5.74V
4	+14.6V	+14.6V	+14.6V	+14.6V
5	+7.17V	+7.17V	+7.17V	+7.17V
6	+7.15V	+7.15V	+7.15V	+7.15V
7	+7.65V	+7.65V	+7.65V	+7.65V
8	+6.69V	+6.69V	+6.69V	+6.69V
9	+7.19V	+7.19V	+7.16V	+7.19V
10	+7.16V	+7.16V	+7.16V	+7.16V
11	Gnd	Gnd	Gnd	Gnd
12	+4.89V	+4.89V	+4.89V	+4.89V
13	+4.89V	+4.89V	+4.89V	+4.89V
14	+5.63V	+5.66V	+5.66V	+5.63V

U3402 Video Converter IC

Pin No.	Load	Play	Pause	Unload
1	0V	+4.17V	+1.15V	0V
2	+5.19V	+4.26V	+5.19V	+5.19V
3	+7.17V	+7.17V	+7.17V	+7.17V
4	+3.61V	+3.16V	+3.16V	+3.16V
5	+7.16V	+7.16V	+7.16V	+7.16V
6	+4.44V	+4.44V	+4.44V	+4.44V
7	+2.22V	+2.22V	+2.22V	+2.22V
8	Gnd	Gnd	Gnd	Gnd
9	+3.61V	+3.61V	+3.61V	+3.61V
10	+8.05V	+8.05V	+8.05V	+8.05V
11	+10.5V	+10.5V	+10.5V	+10.5V
12	+7.16V	+7.16V	+7.16V	+7.16V
13	+7.16V	+7.16V	+7.16V	+7.16V
14	+9.42V	+9.42V	+9.42V	+9.42V
15	+9.42V	+9.42V	+9.42V	+9.42V

U3402 Video Converter IC (continued)

Pin No.	Load	Play	Pause	Unload
16	+3.24V	+3.24V	+3.24V	+3.24V
17	+3.24V	+3.24V	+3.24V	+3.24V
18	+7.83V	+7.72V	+7.03V	+7.83V
19	+11.7V	+11.7V	+11.7V	+11.7V
20	+1.86V	+1.86V	+1.86V	+1.86V
21	+6.76V	+5.26V	+6.76V	+6.76V
22	+0.66V	+6.80V	+0.66V	+0.66V
23	+1.07V	+0.26V	+1.07V	+1.07V
24	+7.18V	+7.18V	+7.18V	+7.18V

U3501 RF Modulator IC

Pin No.	Load	Play	Pause	Unload
1	+7.18V	+7.18V	+7.18V	+7.18V
2	+7.18V	+7.18V	+7.18V	+7.18V
3	+7.18V	+7.18V	+7.18V	+7.18V
4	+7.18V	+7.18V	+7.18V	+7.18V
5	Gnd	Gnd	Gnd	Gnd
6	See Note 6	See Note 6	See Note 6	See Note 6
7	See Note 6	See Note 6	See Note 6	See Note 6
8	See Note 7	See Note 7	See Note 7	See Note 7
9	See Note 7	See Note 7	See Note 7	See Note 7
10	+14.5V	+14.5V	+14.5V	+14.5V
11	+14.7V	+14.7V	+14.7V	+14.7V
12	+9.99V	+9.99V	+9.99V	+9.99V
13	+7.21V	+7.21V	+7.21V	+7.21V
14	+14.7V	+14.7V	+14.7V	+14.7V
15	+14.7V	+14.7V	+14.7V	+14.7V
16	+14.7V	+14.7V	+14.7V	+14.7V
17	+14.2V	+14.2V	+14.2V	+14.2V
18	+7.18V	+7.18V	+7.18V	+7.18V

U4101 (L + R) Audio FM Demod IC (716kHz)

Pin No.	Load	Play	Pause	Unload
1	+3.15V	+3.15V	+3.15V	+3.15V
2	+3.15V	+3.15V	+3.15V	+3.15V
3	+3.15V	+3.15V	+3.15V	+3.15V
4	Gnd	Gnd	Gnd	Gnd
5	+6.94V	+6.94V	+6.94V	+6.94V
6	+7.06V	+7.06V	+7.06V	+7.06V
7	+6.30V	+6.30V	+6.30V	+6.30V
8	+4.21V	+4.21V	+4.21V	+4.21V
9	+5.88V	+5.88V	+5.88V	+5.88V
10	Gnd	Gnd	Gnd	Gnd
11	+5.91V	+5.91V	+5.91V	+5.91V
12	+0.85V	+0.85V	+0.85V	+0.85V
13	+2.06V	+5.84V	+5.84V	+2.06V
14	+11.6V	+11.6V	+11.6V	+11.6V
15	+5.30V	+5.30V	+5.30V	+5.30V
16	+5.30V	+5.30V	+5.30V	+5.30V

Note 6. +13.1V channel 3 operation; +1.47V channel 4 operation.

Note 7. +1.47V channel 3 operation; +13.1V channel 4 operation.

U4102 (L - R) Audio FM Demod IC (905kHz)

Pin No.	Load	Play	Pause	Unload
1	+3.13V	+3.13V	+3.13V	+3.13V
2	+3.13V	+3.13V	+3.13V	+3.13V
3	+3.13V	+3.13V	+3.13V	+3.13V
4	Gnd	Gnd	Gnd	Gnd
5	+6.94V	+6.94V	+6.94V	+6.94V
6	+6.98V	+6.98V	+6.98V	+6.98V
7	+6.28V	+6.28V	+6.28	+6.28V
8	+4.20V	+4.20V	+4.20V	+4.20V
9	+5.86V	+5.86V	+5.86V	+5.86V
10	Gnd	Gnd	Gnd	Gnd
11	+5.88V	+5.88V	+5.88V	+5.88V
12	+0.85V	+0.85V	+0.85V	+0.75V
13	+2.46V	+5.81V	+5.81V	+2.46V
14	+11.6V	+11.6V	+11.6V	+11.6V
15	+5.27V	+5.27V	+5.27V	+5.27V
16	+5.27V	+5.27V	+5.27V	+5.27V

U4400 Decoder Rectifier IC

Pin No.	Load	Play	Pause	Unload
1	+0.98V	+2.32V	+0.98V	+0.98V
2	+1.30V	+1.37V	+1.30V	+1.30V
3	+1.31V	+1.36V	+1.30V	+1.30V
4	+14.7V	+14.7V	+14.7V	+14.7V
5	+1.31V	+1.37V	+1.31V	+1.31V
6	+1.31V	+1.36V	+1.31V	+1.31V
7	+0.98V	+2.28V	+0.98V	+0.98V
8	+1.00V	+0.95V	+1.00V	+1.00V
9	+1.31V	+1.37V	+1.31V	+1.31V
10	+1.31V	+1.36V	+1.31V	+1.31V
11	Gnd	Gnd	Gnd	Gnd
12	+1.31V	+1.36V	+1.31V	+1.31V
13	+1.31V	+1.36V	+1.31V	+1.31V
14	+1.00V	+0.97V	+1.00V	+1.00V

U4200 Track/Hold and Mute (C Mos Switch) IC

Pin No.	Load	Play	Pause	Unload
1	+2.36V	+2.36V	+2.36V	+2.36V
2	+0.95V	+3.88V	+1.43V	+0.95V
3	+6.94V	+6.94V	+6.94V	+6.94V
4	+6.95V	+6.95V	+6.95V	+6.95V
5	+0.59V	+5.61V (1)	+0.59V	+0.59V
6	+0.45V	+5.29V (2)	+0.45V	+0.45V
7	Gnd	Gnd	Gnd	Gnd
8	+7.89V	+7.89V	+7.89V	+7.89V
9	+7.89V	+7.89V	+7.89V	+7.89V
10	+6.92V	+6.92V	+6.92V	+6.92V
11	+6.92V	+6.92V	+6.92V	+6.92V
12	+0.45V	+5.25V (3)	+0.45V	+0.45V
13	0V	0V (4)	0V	0V
14	+9.17V	+8.56V	+9.17V	+9.17V

U4500 Decoder Control IC

Pin No.	Load	Play	Pause	Unload
1	+1.93V	See Note 8	+1.74V	+1.93V
2	+1.43V	See Note 8	+1.43V	+1.43V
3	+1.43V	See Note 8	+1.43V	+1.43V
4	+14.7V	+14.7V	+14.7V	+14.7V
5	+1.43V	See Note 8	+1.43V	+1.43V
6	+1.43V	See Note 8	+1.43V	+1.43V
7	+1.99V	See Note 8	+1.99V	+1.99V
8	0V	See Note 8	+2.36V	0V
9	+1.30V	See Note 8	+1.91V	+1.30V
10	+0.62V	See Note 8	+1.89V	+0.62V
11	Gnd	Gnd	Gnd	Gnd
12	+0.95V	+2.32V	+1.43V	+0.95V
13	+1.16V	+2.30V	+1.43V	+1.16V
14	+0.62V	+6.19V	+1.90V	+0.62V

U4300 Audio Matrix Buffer IC

Pin No.	Load	Play	Pause	Unload
1	+7.91V	+7.91V	+7.91V	+7.91V
2	+7.91V	+7.91V	+7.91V	+7.91V
3	+6.93V	+6.93V	+6.93V	+6.93V
4	+14.7V	+14.7V	+14.7V	+14.7V
5	+7.89V	+7.89V	+7.89V	+7.89V
6	+7.89V	+7.89V	+7.89V	+7.89V
7	+7.87V	+7.87V	+7.87V	+7.87V
8	+9.55V	+9.55V	+9.55V	+9.55V
9	+7.89V	+7.89V	+7.89V	+7.89V
10	+7.89V	+7.89V	+7.89V	+7.89V
11	Gnd	Gnd	Gnd	Gnd
12	+6.94V	+6.94V	+6.94V	+6.94V
13	+7.92V	+7.92V	+7.92V	+7.92V
14	+7.92V	+7.92V	+7.92V	+7.92V

U4600 Audio Output IC

Pin No.	Load	Play	Pause	Unload
1	+0.09V	+1.22V	+1.10V	+0.09V
2	+8.68V	+8.68V	+8.68V	+8.68V
3	+8.07V	+8.07V	+8.07V	+8.07V
4	+8.07V	+8.07V	+8.07V	+8.07V
5	+7.85V	+7.69V	+7.85V	+7.85V
6	Gnd	Gnd	Gnd	Gnd
7	+7.83V	+7.67V	+7.83V	+7.83V
8	+6.64V	+6.49V	+6.64V	+6.64V
9	+6.64V	+6.67V	+6.64V	+6.64V
10	+7.83V	+7.83V	+7.83V	+7.83V
11	+14.6V	+14.6V	+14.6V	+14.6V
12	+7.85V	+7.88V	+7.85V	+7.85V
13	+8.07V	+8.07V	+8.07V	+8.07V
14	+8.07V	+8.07V	+8.07V	+8.07V
15	+8.68V	+8.68V	+8.68V	+8.68V
16	+0.09V	+1.22V	+1.10V	+0.09V

Note 8. Voltage varies when playing stereo VideoDisc due to processing action of time constant network.

1983 SJT 400 TRANSISTOR VOLTAGE CHART

Q401	E	+3.07V	Q2502	E	+0.34V	Q3201	E	+5.62V	Q3407	E	+7.15V
	B	+3.80V		B	+0.90V		B	+6.29V		B	Varies
	C	+7.84V		C	+14.6V		C	+8.52V		C	+14.7V
Q402	E	+7.08V	Q2503	E	Gnd	Q3202	E	+5.51V	Q3408	E	+7.14V
	B	+7.84V		B	+0V		B	+6.17V		B	Varies
	C	+14.4V		C	+5.84V		C	+11.5V		C	Gnd
Q403	E	+1.08V	Q2504	G	+3.42V	Q3301	E	+4.40V	Q3409	E	Gnd
	B	+2.38V		S	+6.42V		B	+5.03V		B	+0.11V
	C	+7.42V		D	+6.64V		C	+14.6V		C	+4.09V
Q404	E	+1.81V	Q2505	E	+11.6V	Q3303	E	+4.50V	Q3412	E	+3.90V
	B	+2.41V		B	+11.1V		B	+5.16V		B	+4.60V
	C	+14.7V		C	+8.73V		C	+14.6V		C	+5.85V
Q405	A	+7.43V	Q2506	E	+5.94V	Q3304	E	+3.88V	Q3413	E	+5.20V
	G	+12.1V		B	+5.52V		B	+4.49V		B	+5.85V
	K	Gnd		C	+0.18V		C	+14.6V		C	+11.5V
Q2001	E	+22.6V	Q2507	E	Gnd	Q3305	E	+5.65V	Q3501	E	+14.7V
	B	+21.9V		B	+0.18V		B	+5.06V		B	+13.9V
	C	+14.7V		C	+0V		C	Gnd		C	+14.6V
NOT USED SJT 100											
Q2002	E	+23.0V	Q2701	E	+6.46V	Q3306	E	+4.46V	Q4102	E	Gnd
	B	+22.7V		B	+7.13V		B	+5.11V		B	+0.65V
	C	+21.9V		C	+14.7V		C	+11.9V		C	+0.02V
Q2003	E	+2.72V	Q3101	E	+8.83V	Q3401	E	+8.31V	Q4301	E	+7.15V
	B	+3.34V		B	+9.47V		B	+8.98V		B	+7.79V
	C	+21.9V		C	+14.5V		C	+14.6V		C	+14.6V
Q2004	E	+12.1V	Q3102	E	+9.49V	Q3402	E	+3.62V	Q4302	E	+7.15V
	B	+12.7V		B	+8.83V		B	+4.26V		B	+7.79V
	C	+14.1V		C	+4.81V		C	+8.97V		C	+14.6V
Q2005	E	+5.04V	Q3103	E	+4.16V	Q3403	E	+5.61V	Q4501	E	+1.93V
	B	+5.65V		B	+4.82V		B	+6.26V		B	+1.33V
	C	+11.2V		C	+10.3V		C	+9.08V		C	+1.26V
Q2006	E	+4.90V	Q3104	E	+9.60V	Q3404	E	+8.39V	Q5101	E	+3.01V
	B	+5.04V		B	+10.3V		B	+9.04V		B	+4.70V
	C	+5.65V		C	+14.5V		C	+13.9V		C	+2.07V
Q2007	E	+11.9V	Q3105	E	+0.9V	Q3405	E	+7.20V	Q5102	E	+3.01V
	B	+12.1V		B	+1.52V		B	Varies		B	+2.55V
	C	+12.7V		C	+7.72V		C	+14.7V		C	+2.70V
Q2501	E	+6.63V	Q3107	E	+4.72V	Q3406	E	+7.20V	Q5103	E	Gnd
	B	+7.28V		B	+5.28V		B	Varies		B	+0.68V
	C	+12.9V		C	+7.80V		C	Gnd		C	+0.02V

Q5104	E	Gnd
	B	Steps Hi-Lo
	C	Steps Hi-Lo
Q5105	E	Steps Hi-Lo
	B	Steps Hi-Lo
	C	Steps Hi-Lo
Q5106	E	+22.9V
	B	+22.8V
	C	Steps Hi-Lo
Q5107	E	Gnd
	B	Steps Hi-Lo
	C	Steps Hi-Lo
Q5108	E	+3.27V
	B	+3.91V
	C	+3.84V
Q5109	E	+13.1V
	B	+12.3V
	C	+13.0V
Q5110	E	+3.89V
	B	+4.50V
	C	+8.71V
Q5111	E	Steps Hi-Lo
	B	Steps Hi-Lo
	C	+22.0v
Q5112	E	+22.0V
	B	Steps Hi-Lo
	C	Steps Hi-Lo
Q5113	E	+4.90V
	B	+4.55V
	C	+3.01V
Q5114	E	+4.90V
	B	+4.58V
	C	+3.90V

Q5115	E	Gnd
	B	+0.74V
	C	+0.02V
Q5116	E	Gnd
	B	+0.02V
	C	+4.87V
Q5301	E	Gnd
	B	+0.70V
	C	+0.02V
Q5302	E	Gnd
	B	+0.66V
	C	+0.06V
Q5303	E	+4.74V
	B	+5.12V
	C	+22.5V
Q5304	E	+4.75V
	B	+5.12V
	C	Gnd
Q5305	E	+4.28V
	B	+4.75V
	C	+22.5V
Q5306	E	+4.28V
	B	+4.75V
	C	Gnd
		NORM REV/ RUN
Q5901	E	Gnd
	B	+0.70V +0.75V
	C	+0.02V 0V
		NORM REV/ RUN
Q5902	E	+0.02V +0.88V
	B	+0.02V +0.09V
	C	+22.6V +19.2V

		NORM	FWD/ RUN
Q5903	E	Gnd	Gnd
	B	+0.69V	+0.74V
	C	+0.02V	+0.11V
		NORM	FWD/ RUN
Q5904	E	+0.02V	+0.91V
	B	+0.02V	+0.11V
	C	+23.3V	+19.2V
		NORM	FWD/ RUN
Q5905	E	+0.02V	+0.91V
	B	+0.02V	+0.91V
	C	+23.3V	+19.2V
		NORM	REV/ RUN
Q5906	E	+0.02V	+0.87V
	B	+0.02V	+0.87V
	C	+22.8V	+18.8V
		NORM	MOMENT SWITCH
Q5907	E	+4.85V	+0.99V
	B	+4.85V	+0.99V
	C	Gnd	Gnd
		STOP	RUN
Q5921	E	+23.4V	+22.6V
	B	+23.4V	+22.6V
	C	0V	+1.58V
		STOP	RUN
Q5922	E	+0.05V	+0.10V
	B	+0.25V	+0.33V
	C	+23.4V	+21.3V
		STOP	RUN
Q5923	E	0V	+0.02V
	B	+0.05V	+0.10V
	C	+0.24V	+6.50V

		STOP	RUN
Q5931	E	+23.5V	+22.6V
	B	+23.5V	+22.6V
	C	0V	+1.58V
		STOP	RUN
Q5932	E	+0.05V	+0.10V
	B	+0.25V	+0.33V
	C	+23.4V	+21.3V
		STOP	RUN
Q5933	E	0V	+0.02V
	B	+0.05V	+0.10V
	C	+0.24V	+6.35V
		STOP	RUN
Q5941	E	+23.4V	+22.6V
	B	+23.4V	+22.6V
	C	0V	+1.58V
		STOP	RUN
Q5942	E	+0.05V	+0.10V
	B	+0.25V	+0.33V
	C	+23.4V	+22.3V
		STOP	RUN
Q5943	E	0V	+0.02V
	B	+0.05V	+0.10V
	C	+0.24V	+6.30V
		STOP	RUN
Q5951	E	+23.4V	+22.6V
	B	+23.4V	+22.6V
	C	0V	+1.58V
		STOP	RUN
Q5952	E	+0.05V	+0.10V
	B	+0.25V	+0.33V
	C	+23.4V	+22.3V
		STOP	RUN
Q5953	E	0V	+0.02V
	B	+0.05V	+0.10V
	C	+0.24V	+6.30V

NOTE: Voltages measured with DVM—Player in "PLAY" mode unless otherwise indicated.

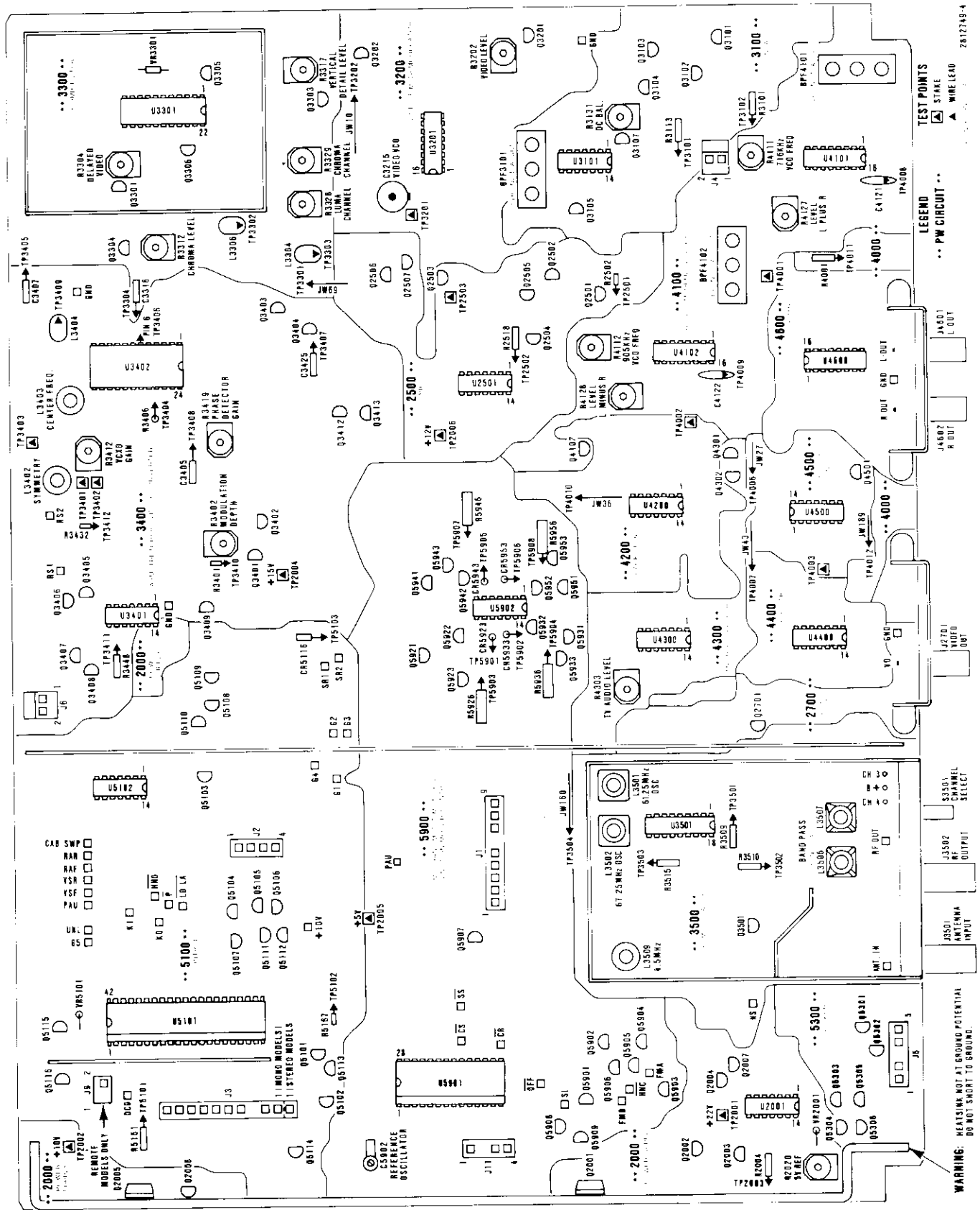

Fig. 26—Test Point and Active Device Location

TEST POINTS

TP2001 +22VDC
 TP2002 +10VDC
 TP2003 +5.0V Ref
 TP2004 +15VDC (In 3400 Area)
 TP2005 +5VDC
 TP2006 +12VDC (In 2500 Area)
 TP2501 FM In
 TP2502 Detector Out
 TP2503 Defect Input
 TP3101 Anlac Setup
 TP3102 Arm Input
 TP3201 5.3MHz VCO
 TP3202 Video Input to U3301
 TP3301 Vertical Detail Out
 TP3302 Luminance Out
 TP3303 Vertical Detail
 TP3304 1.53MHz Chroma
 TP3401 VCXO Setup
 TP3402 VCXO Input
 TP3403 +7VDC Ref
 TP3404 Luminance Input
 TP3405 1.53MHz Clock
 TP3406 3.58MHz Oscillator
 TP3407 1.53MHz Clock Buffered
 TP3408 Phase Detector Output
 TP3409 5.11MHz Oscillator
 TP3410 Video Input to Modulator
 TP3411 Armstretcher Setup
 TP3501 Channel 3 Output
 TP3502 Channel 4 Output
 TP3503 4.5MHz Input
 TP3504 Audio Input
 TP4001 Left Plus Right Output
 TP4002 Left Minus Right Output
 TP4003 Rectified Output
 TP4006 Left Matrix Output
 TP4007 Right Matrix Output
 TP4008 716KHz VCO
 TP4009 905KHz VCO
 TP4010 Decoder Disable
 TP4011 +7.5VDC Ref
 TP4012 +1.4VDC Ref
 TP5101 Audio Channel A Mute
 TP5102 Audio Channel B Mute
 TP5103 Squelch
 TP5901 Turntable Motor Drive
 Voltage B
 TP5902 Turntable Motor Drive
 Voltage A
 TP5903 Turntable Motor Drive
 Current B
 TP5904 Turntable Motor Drive
 Current A
 TP5905 Turntable Motor Drive
 Voltage D
 TP5906 Turntable Motor Drive
 Voltage C
 TP5907 Turntable Motor Drive
 Current D
 TP5908 Turntable Motor Drive
 Current C

ACTIVE DEVICES

Q2001 Regulator
 Q2002 Current Limiter
 Q2003 Driver
 Q2004 Regulator
 Q2005 Regulator
 Q2006 Current Limiter
 Q2007 Current Limiter
 Q2501 RF Amplifier
 Q2502 Output Detector/Switch
 Q2503 Output Detector/Switch
 Q2504 Gain Control
 Q2505 AGC Amplifier
 Q2506 Sync Stripper
 Q2507 Clamp
 Q2701 Video Driver
 Q3101 N-Lac Buffer
 Q3102 N-Lac Amplifier
 Q3103 N-Lac Amplifier
 Q3104 N-Lac Output Driver
 Q3105 716KHz Amplifier
 Q3107 Control Amplifier
 Q3201 Phase Corrector
 Q3202 Video Buffer
 Q3301 Delayed Video Drive
 Q3303 Vertical Detail Buffer
 Q3304 Chroma Driver
 Q3305 Chroma Buffer
 Q3306 Luma Buffer
 Q3401 Video Buffer
 Q3402 Video Amplifier
 Q3403 Clock Phase Shifter
 Q3404 Clock Buffer
 Q3405 Transducer Driver
 Q3406 Transducer Driver
 Q3407 Transducer Driver
 Q3408 Transducer Driver
 Q3409 Video Blanker
 Q3412 Noise Coring Amplifier
 Q3413 Noise Coring Buffer
 Q3501 Bias Switch
 Q4102 Decoder Defeat
 Q4301 Left Channel Buffer
 Q4302 Right Channel Buffer
 Q4501 Current Source
 Q5101 Least Significant Digit Driver
 Q5102 Most Significant Digit Driver
 Q5103 Daxi Status Inverter
 Q5104 Stepper Output B
 Q5105 Stepper Drive A
 Q5106 Stepper Output A
 Q5107 Stepper Output D
 Q5108 Lifter Drive
 Q5109 Lifter Output
 Q5110 Vertical Detail Driver
 Q5111 Stepper Drive C
 Q5112 Stepper Output C
 Q5113 LED Display Select
 Q5114 Discrete LED Select
 Q5115 Low Voltage Detector
 Q5116 Reset Switch
 Q5301 Reverse Ramp Switch

ACTIVE DEVICES (Continued)

Q5302 Forward Ramp Switch
 Q5303 Kick Pulse Driver
 Q5304 Kick Pulse Driver
 Q5305 Kick Pulse Output
 Q5306 Kick Pulse Output
 Q5901 Reverse Function Switch
 Q5902 Function Drive Reverse
 Q5903 Forward Function Switch
 Q5904 Function Drive Forward
 Q5905 Function Motor Output
 Forward
 Q5906 Function Motor Output
 Reverse
 Q5907 Pause Line Buffer
 Q5908 Rev. Driver Switch
 Q5909 Fwd. Driver Switch
 Q5921 Current Source Switch
 Q5922 Drive Amplifier
 Q5923 Turntable Motor Driver B
 Q5931 Current Source Switch
 Q5932 Drive Amplifier
 Q5933 Turntable Motor Driver A
 Q5941 Current Source Switch
 Q5942 Drive Amplifier
 Q5943 Turntable Motor Driver D
 Q5951 Current Source Switch
 Q5952 Drive Amplifier
 Q5953 Turntable Motor Driver C
 U2001 Quad Operational Amplifier
 U2501 Sync Detector
 U3101 Sync Detector
 U3201 Video FM Demodulator
 U3301 Comb Filter/Defect Corrector
 U3401 Armstretcher Drive
 U3402 Video Converter
 U3501 RF Modulator
 U4101 Audio Demodulator
 U4102 Audio Demodulator
 U4200 Track/Hold Mute
 U4300 Audio Matrix & Buffer
 U4400 Decoder Rectifier
 U4500 Decoder Control
 U4600 Decoder Amplifier
 U5101 Player Control
 Microcomputer
 U5102 Daxi Buffer
 U5901 Mechanism Microcomputer
 U5902 Turntable Drive
 VR2001 5.8V Zener
 VR3301 9.1V Zener
 VR5101 2.85V Zener

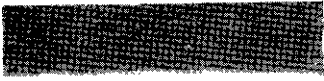

① 5mS/Div. .4V p-p



② 5mS/Div. .8V p-p

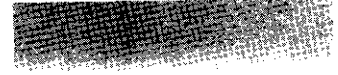
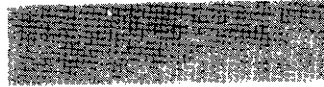

③ 5mS/Div. 5V p-p

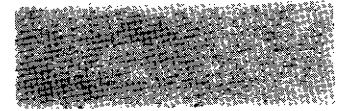

④ 5mS/Div. .3V p-p

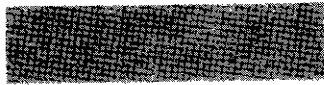

⑤ 5mS/Div. .3V p-p



⑥ 5mS/Div. .3V p-p



⑦ 5mS/Div. .3V p-p



⑧ 5mS/Div. .3V p-p

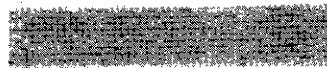

⑨ 5mS/Div. .3V p-p

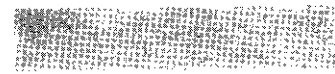

⑩ 5mS/Div. .6V p-p

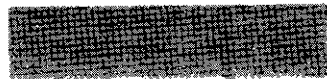

⑪ 5mS/Div. .4V p-p



⑫ 5mS/Div. 25V p-p



⑬ 5mS/Div. .4V p-p



⑭ 5mS/Div. 1.5V p-p

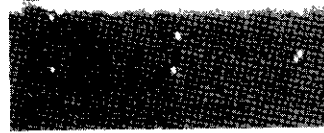

⑮ 5mS/Div. .3V p-p





16 5mS Div. 35V p-p

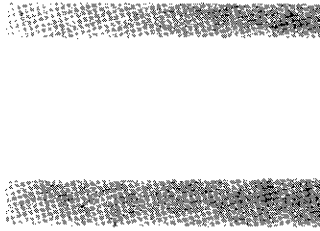

17 5mS Div. .8V p-p

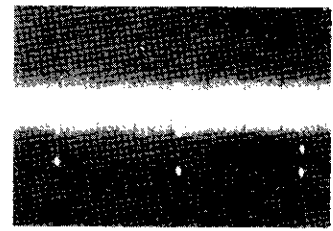

18 5mS Div. 2V p-p

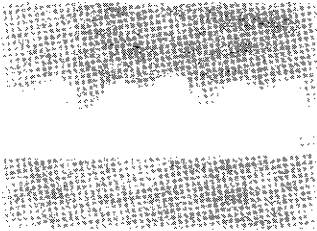

19 5mS Div. 2V p-p

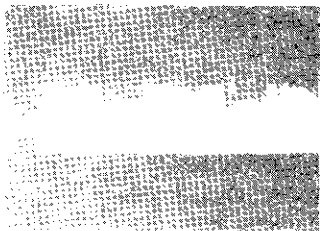

20 5mS Div. 2V p-p

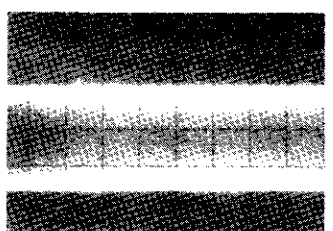

21 5mS Div. 5.5V p-p

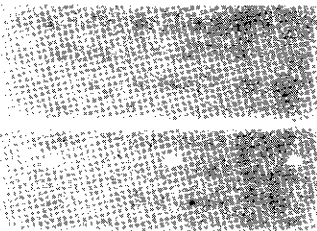

22 5mS Div. 5V p-p

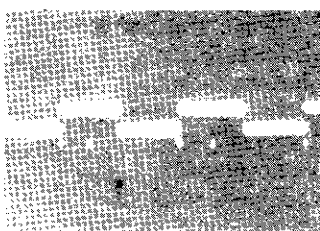

23 2mS Div. 75mV p-p



24 5mS Div. 3V p-p

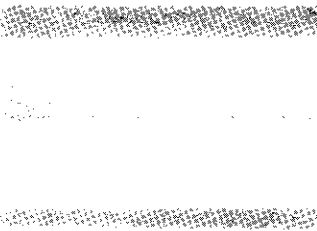

25 5mS Div. 4.2V p-p

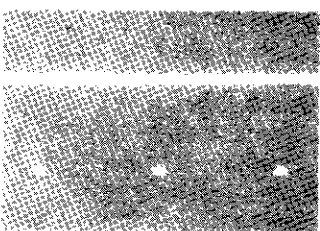

26 10mS Div. 5V p-p

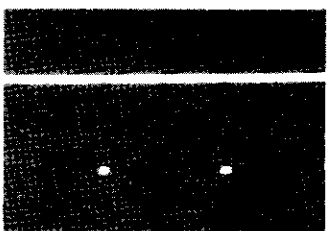

27 10mS Div. 5V p-p

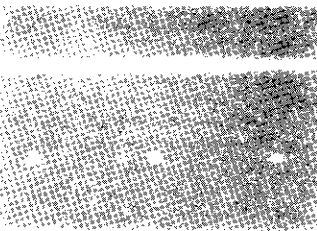

28 10mS Div. 5V p-p

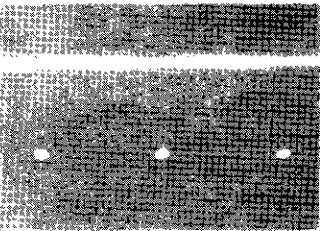

29 10mS Div. 5V p-p

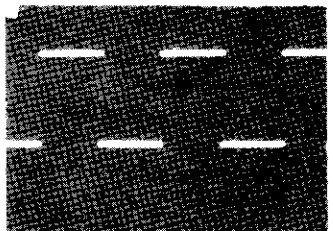

30 10mS Div. 4V p-p

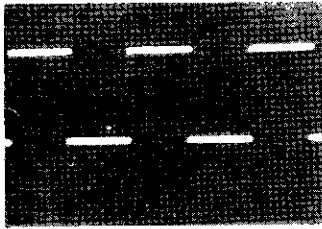

31 10mS/Div. 4V p-p

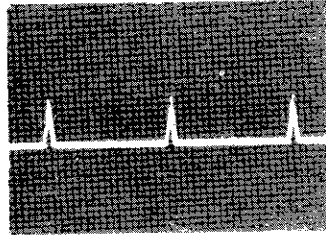

32 10mS/Div. .2V p-p

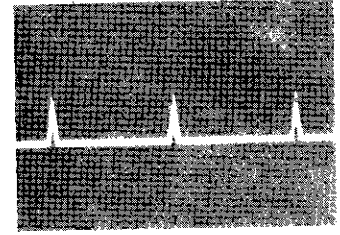

33 10mS/Div. .22V p-p

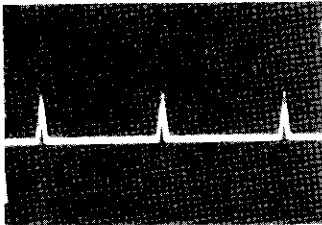

34 10mS/Div. .2V p-p

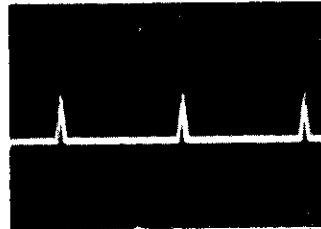

35 10mS/Div. .2V p-p

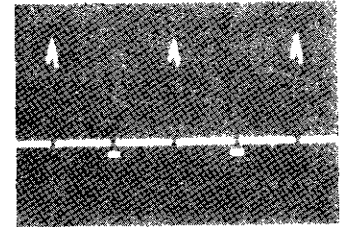

36 10mS/Div. 1.5V p-p

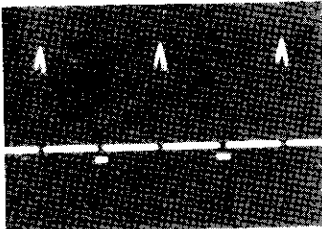

37 10mS/Div. 1.5V p-p

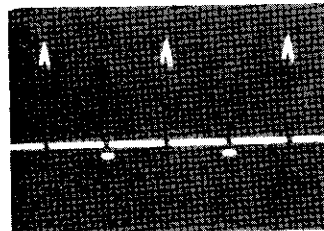

38 10mS/Div. 1.5V p-p

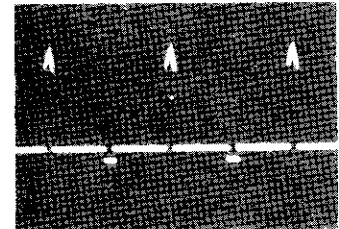

39 10mS/Div. 1.5V p-p

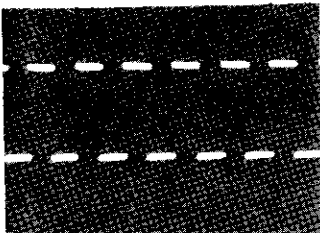

40 5mS/Div. 5V p-p

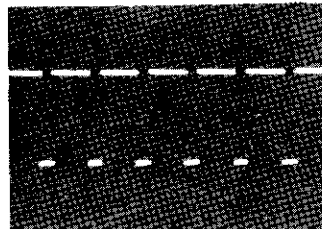

41 5mS/Div. 5V p-p

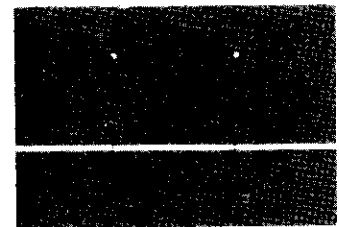

42 5mS/Div. 5V p-p

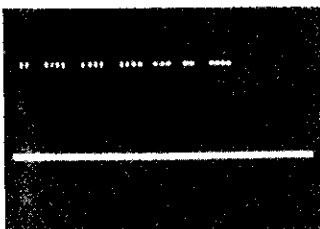

43 1mS/Div. 5V p-p

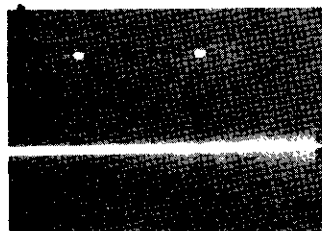

44 5mS/Div. 5V p-p

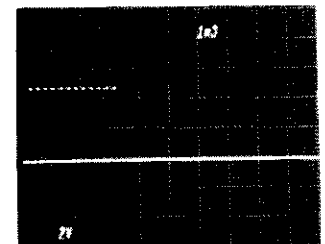

45 U6101 Pin 5

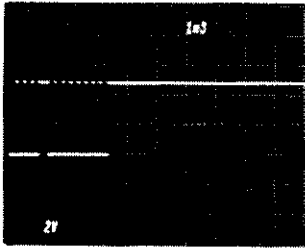

(46) U6101 Pin 6

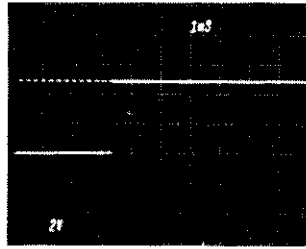

(47) U6101 Pin 7

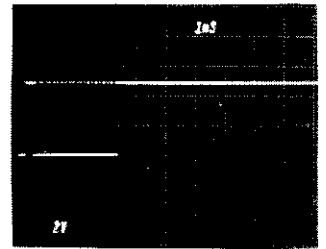

(48) U6101 Pin 8

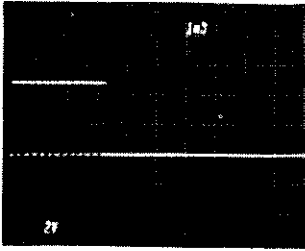

(49) U6101 Pin 9

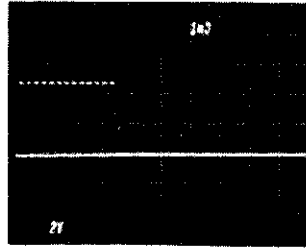

(50) U6101 Pin 10

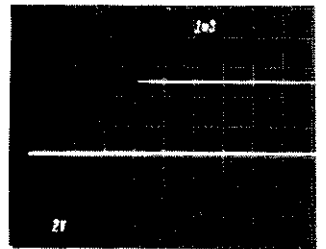

(51) U6101 Pin 11

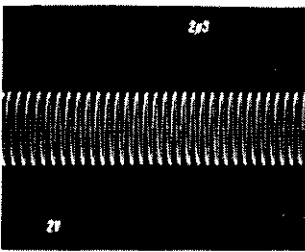

(52) U6101 Pin 16

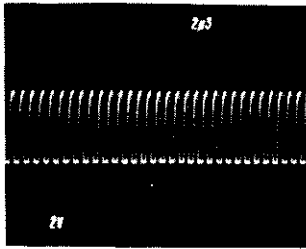

(53) U6101 Pin 17

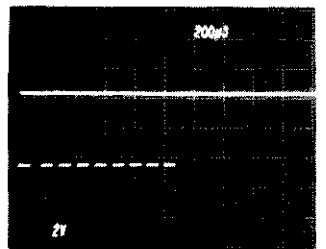

(54) U6101 Pin 22

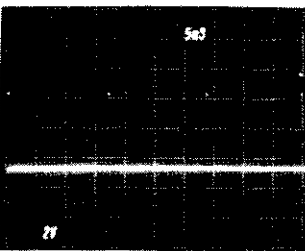

(55) U6101 Pin 23

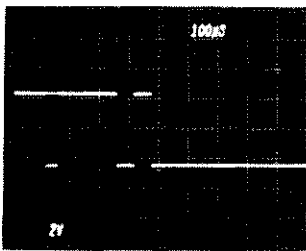

(56) U6101 Pin 24

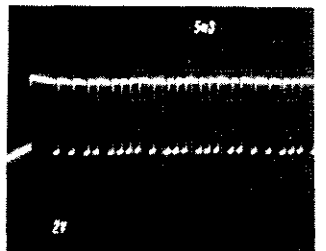

(57) U6102 Pin 12
CRK36 Pause Button Depressed

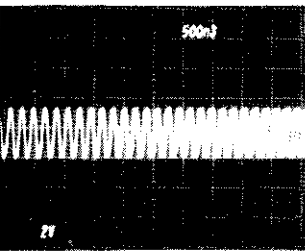

(58) U6103 Pin 1

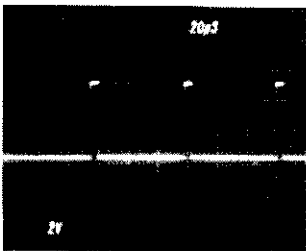

(59) U6103 Pin 2

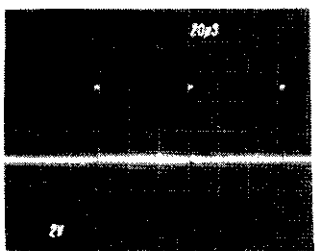

(60) U6103 Pin 3

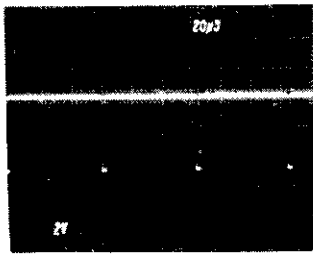

61 U6103 Pin 4

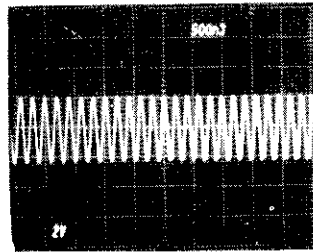

62 U6103 Pin 5

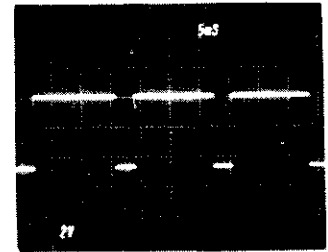

63 U6103 Pin 9

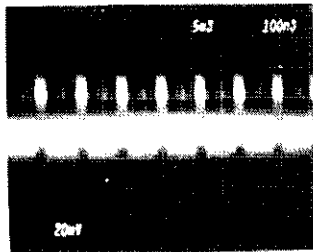

64 U6103 Pin 10

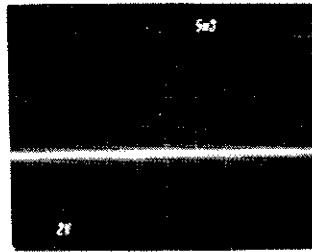

65 U6103 Pin 11

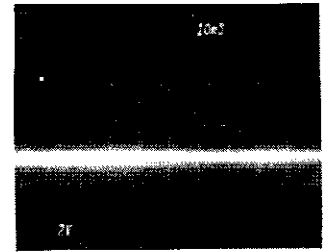

66 U6103 Pin 12

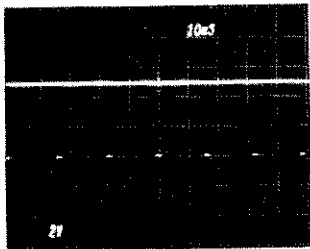

67 U6103 Pin 13

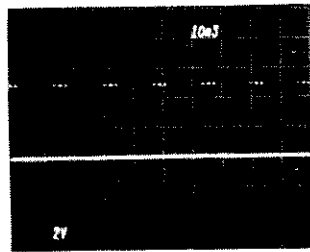

68 U6103 Pin 14

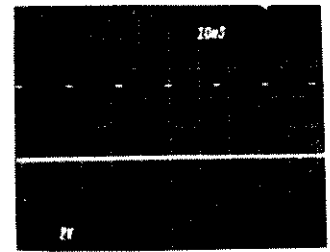

69 U6103 Pin 15

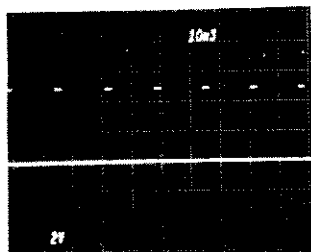

70 U6103 Pin 16

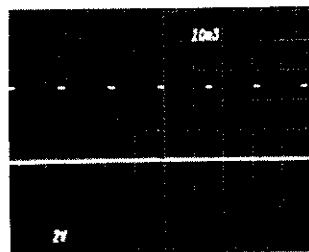

71 U6103 Pin 17

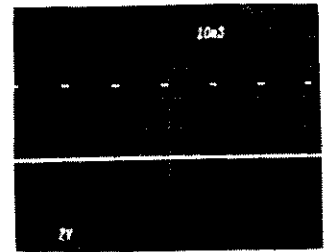

72 U6103 Pin 18

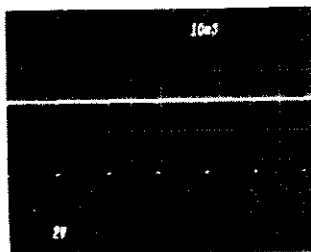

73 U6103 Pin 19

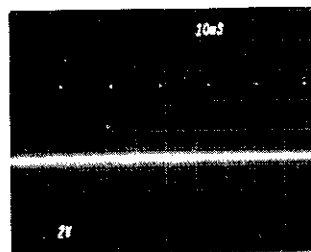

74 U6103 Pin 23

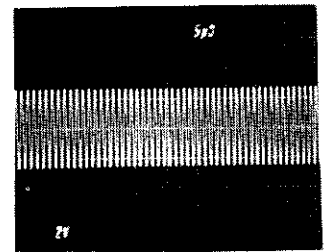

75 U6103 Pins 26 & 27

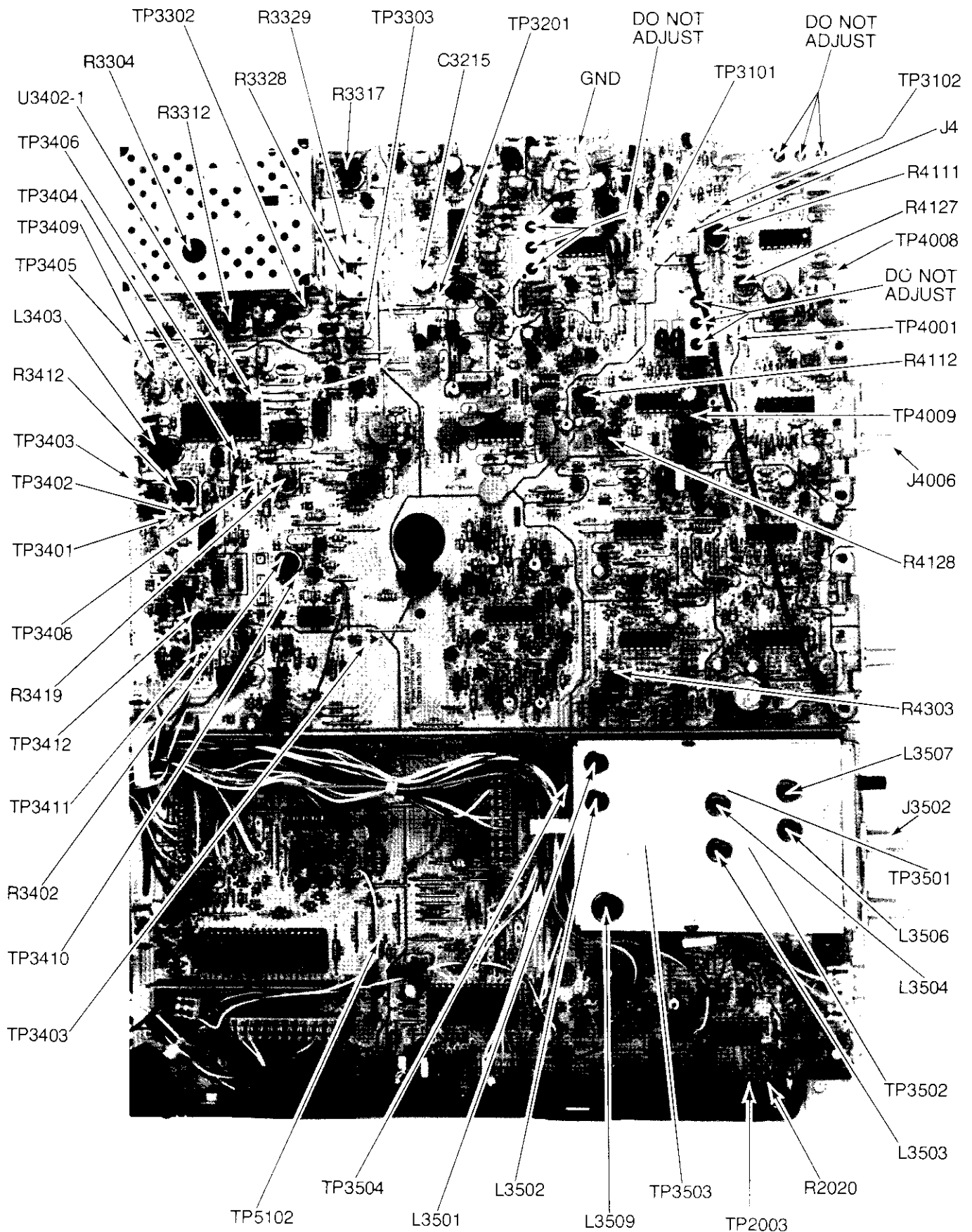

Fig. 28—Adjustment Points

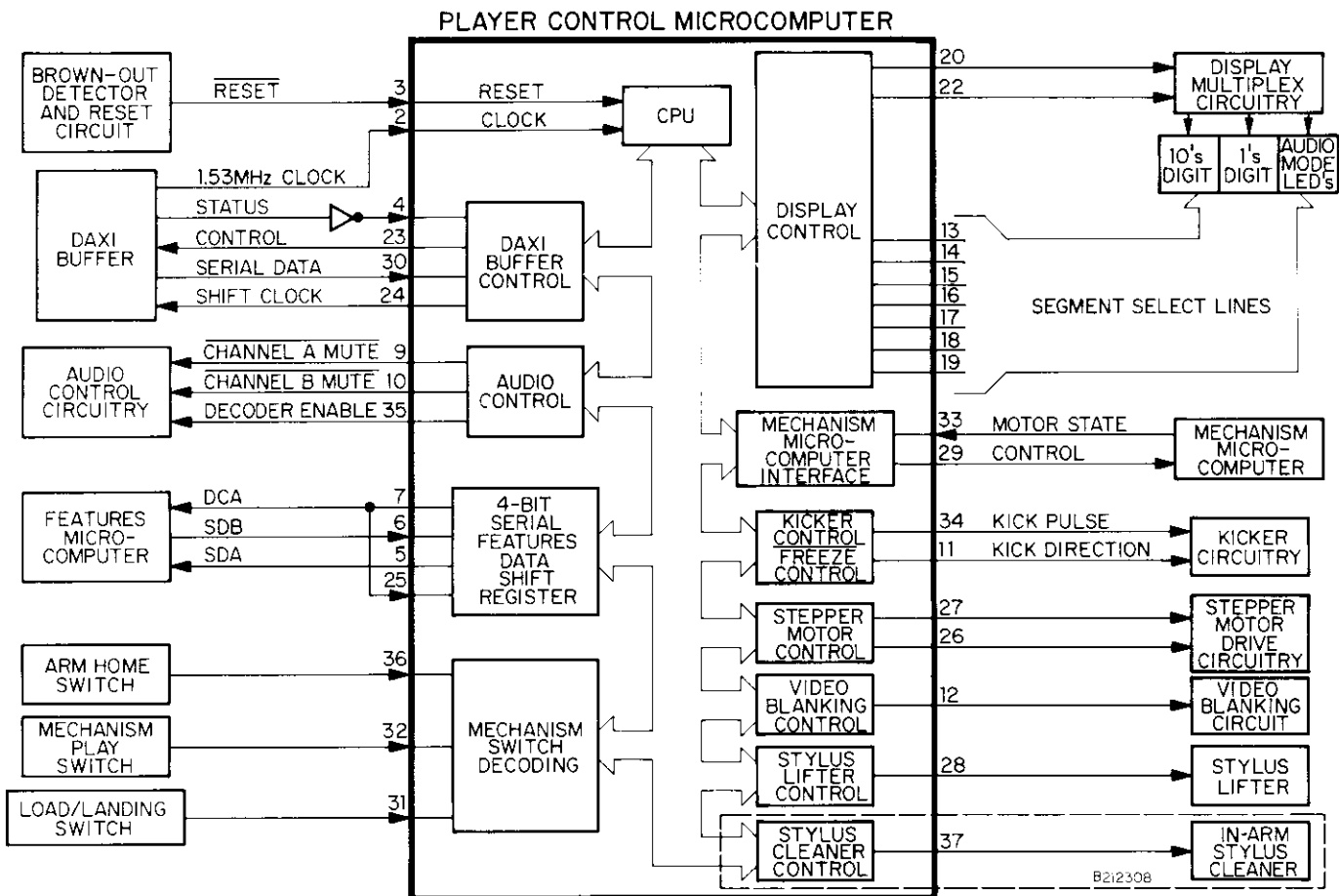

Fig. 29—U5105 Player Control μ C

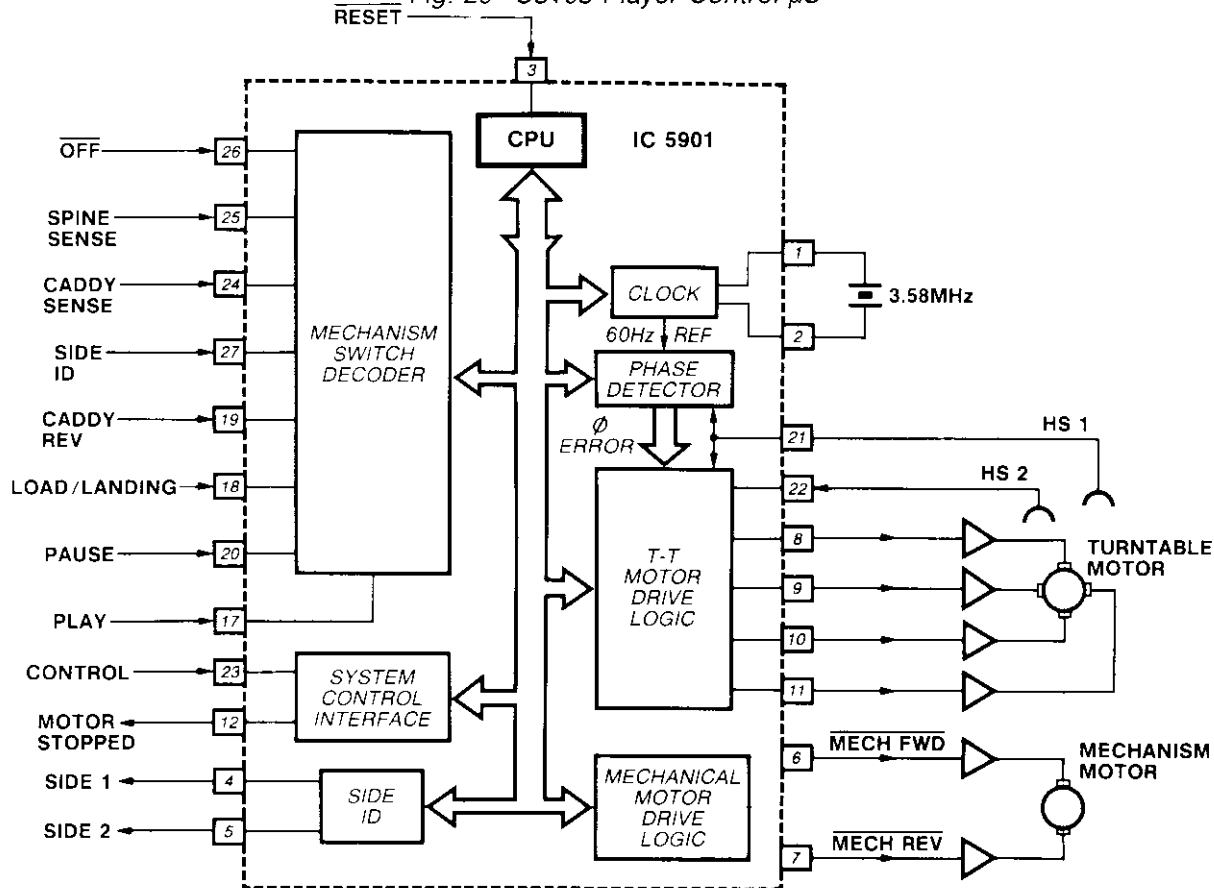

Fig. 30—U5901 Mechanism Control μ C

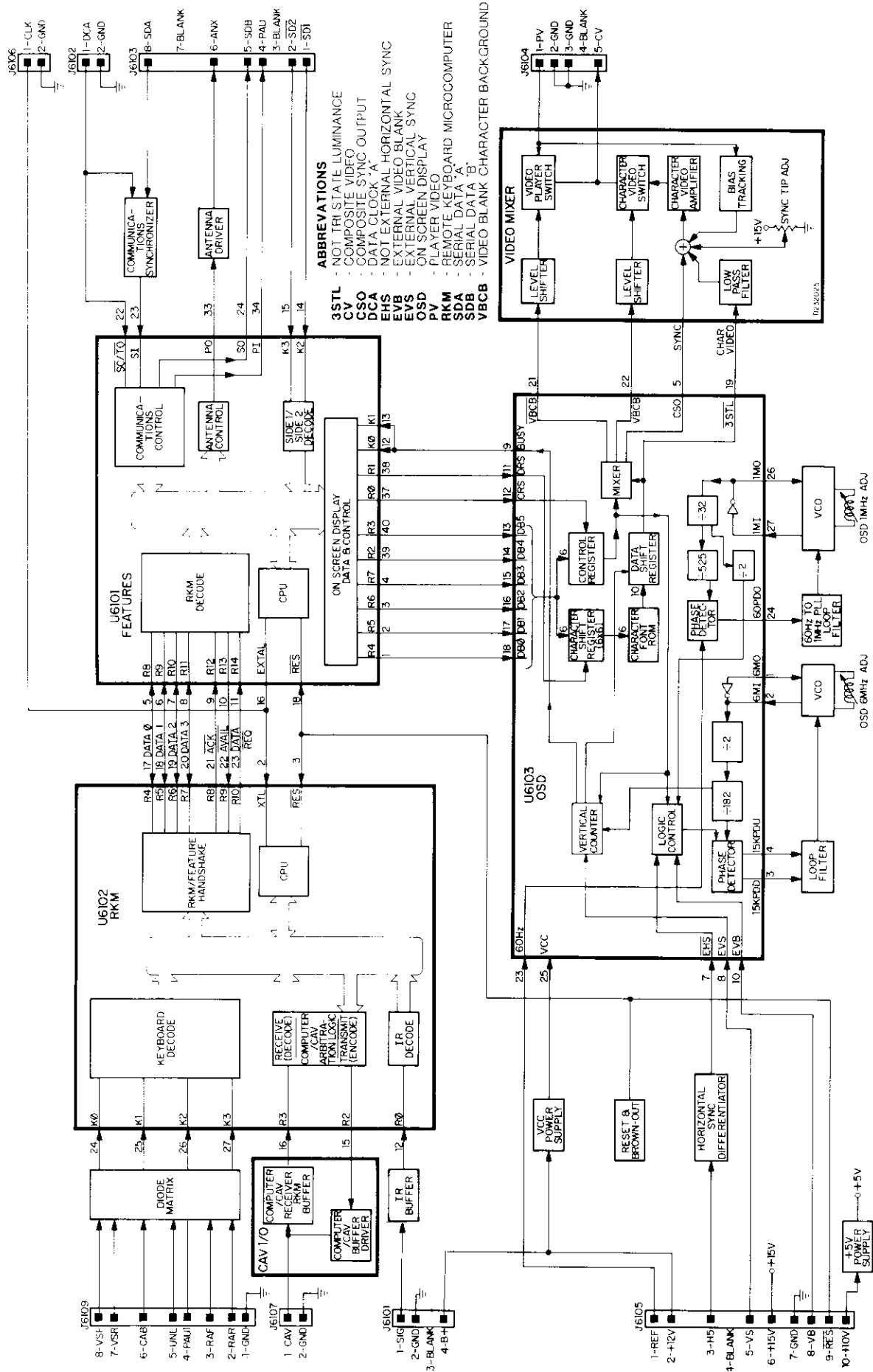

Fig. 31—PW6100 Functional Block Diagram

STAR or SHADING (*)
See PRODUCT SAFETY NOTICE
on page 2 of Basic Service Data.

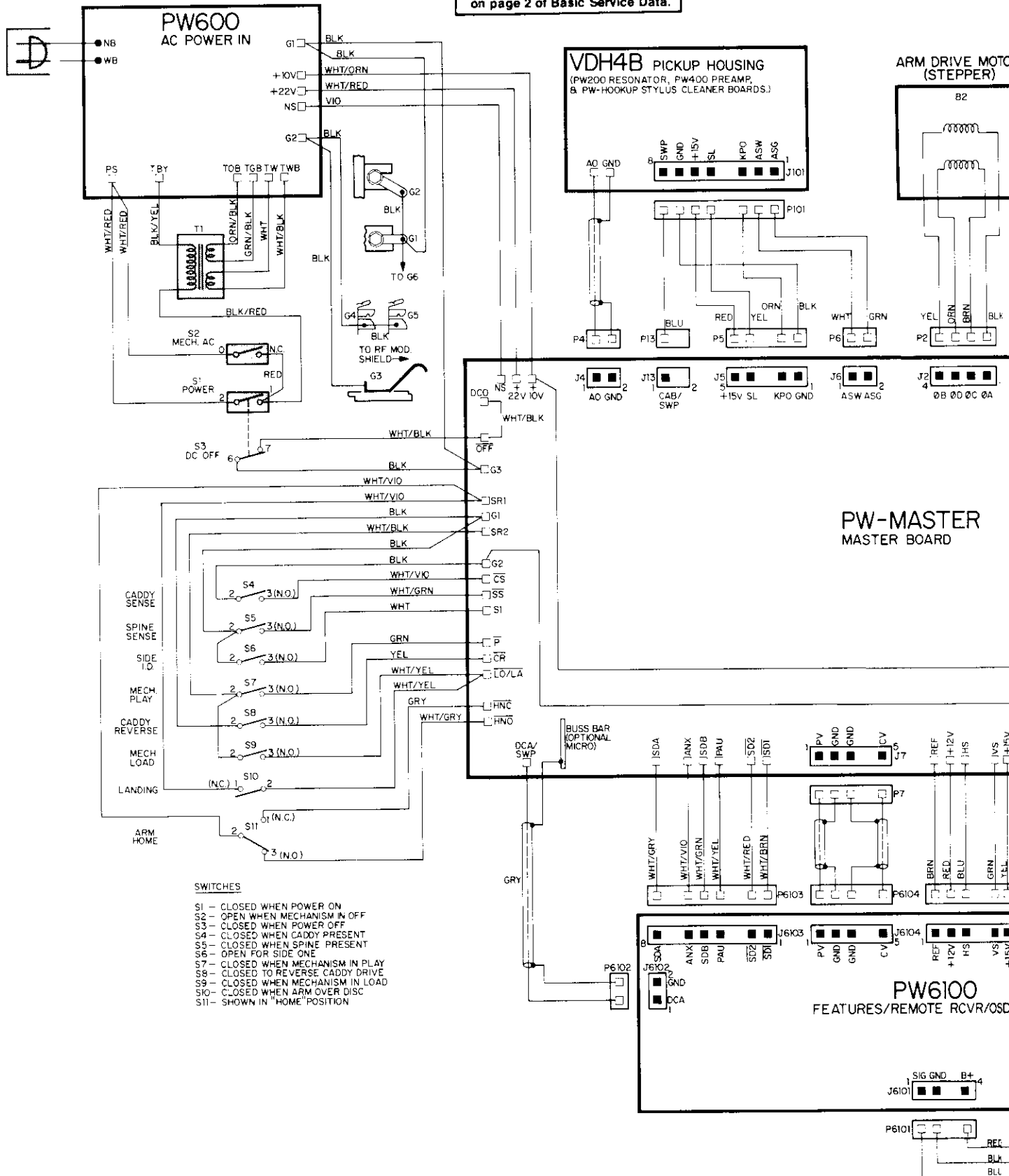
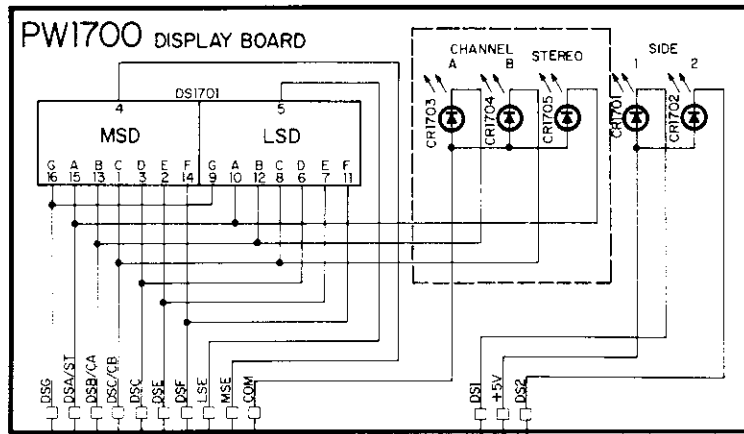
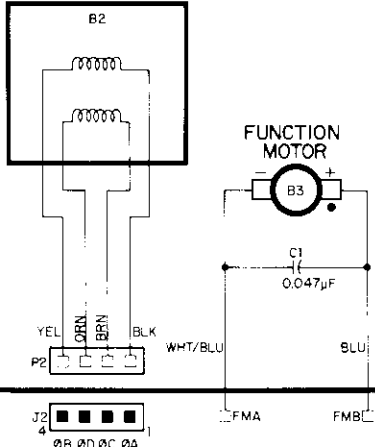
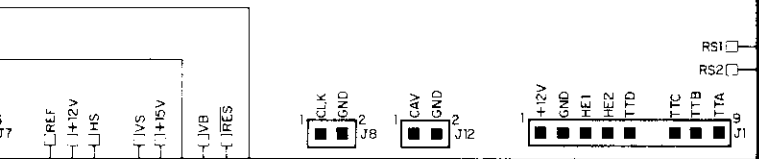

Fig. 32—Interconnect

ARM DRIVE MOTOR (STEPPER)



MASTER BOARD



PW6100 REMOTE RCVR/OSD BOARD

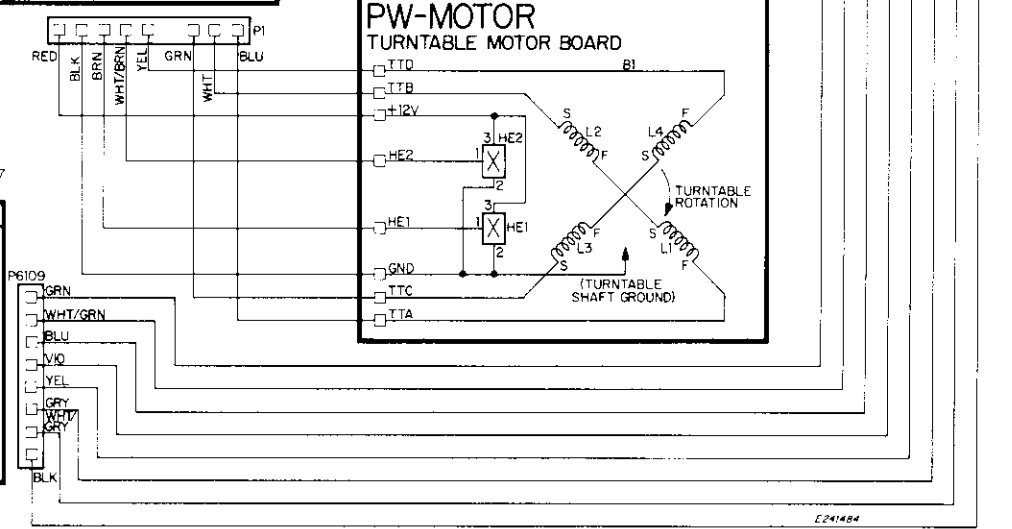
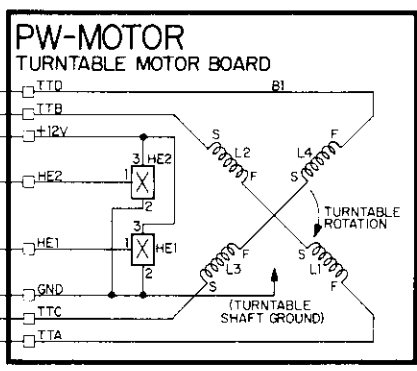
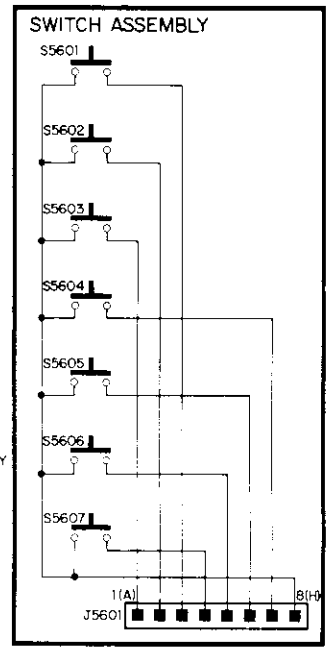
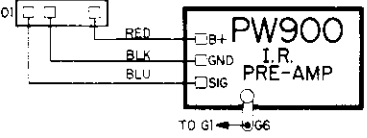

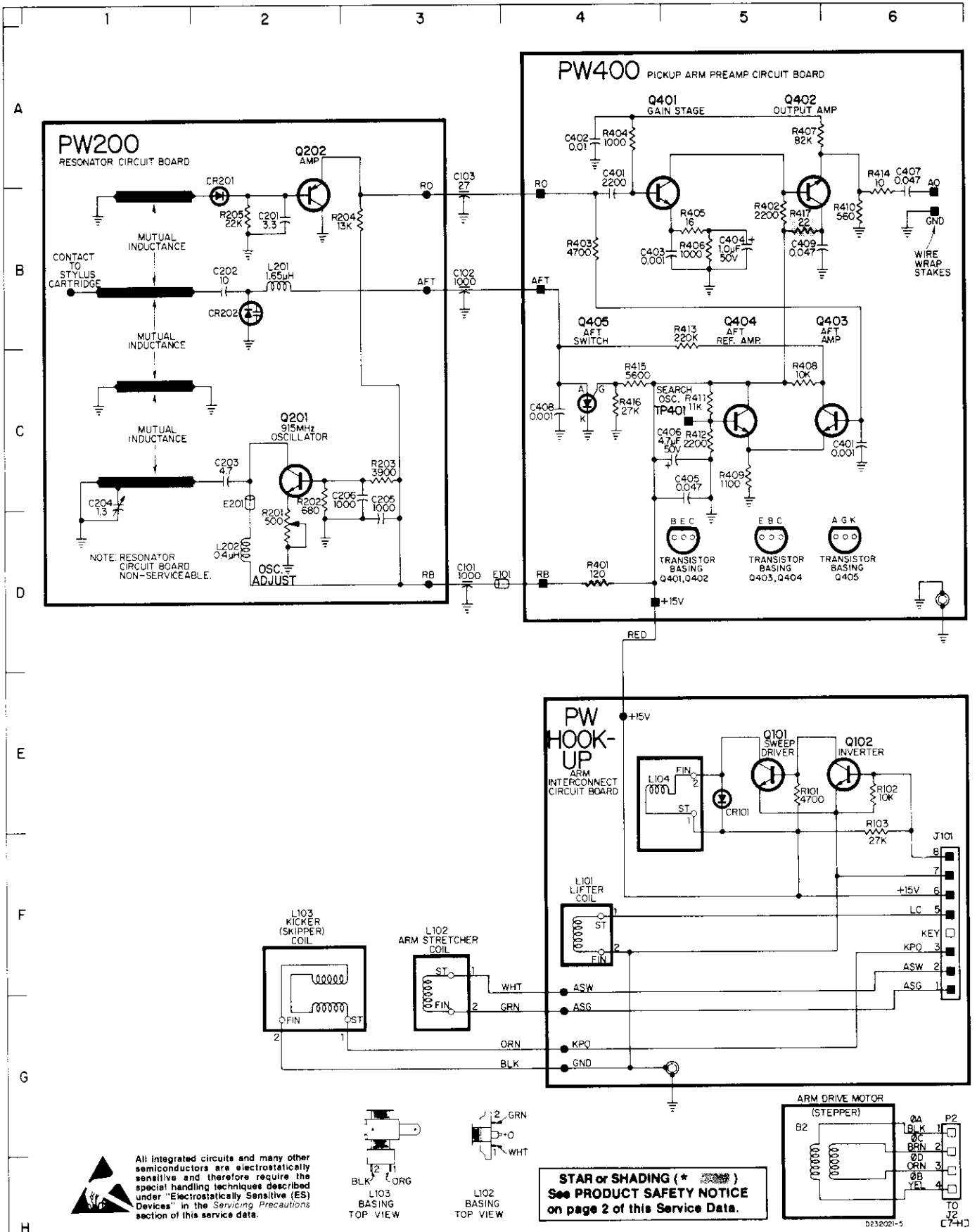
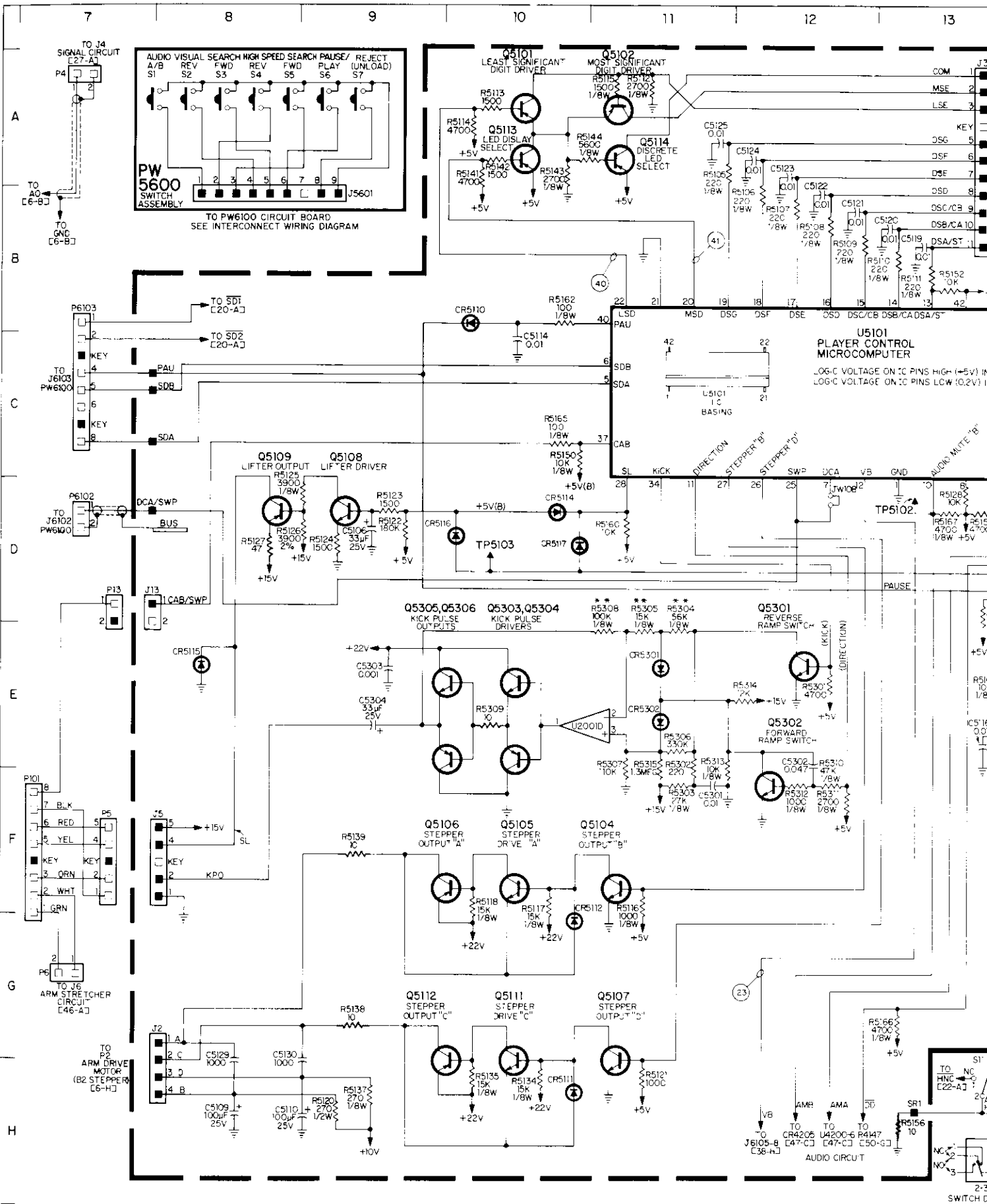
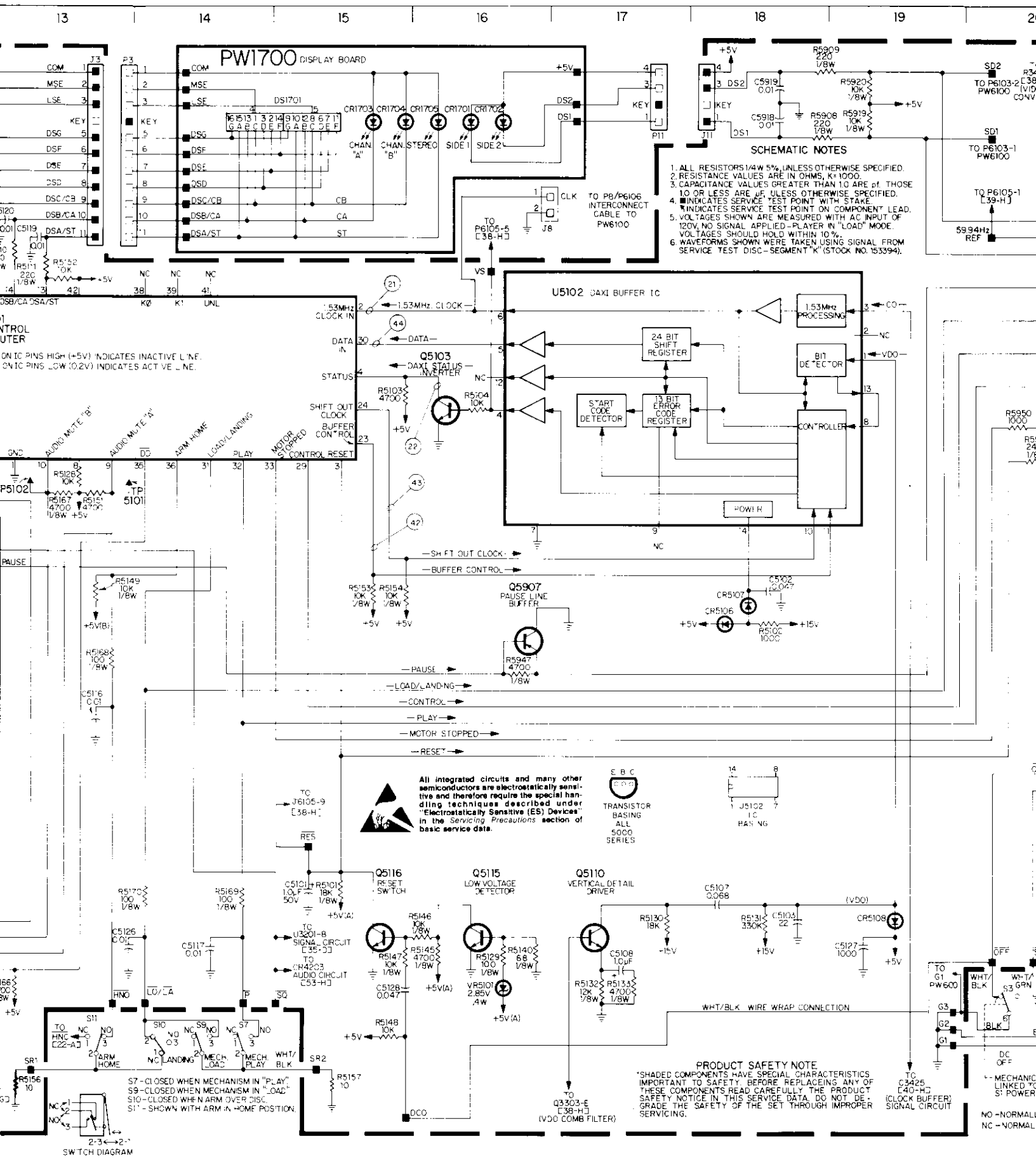

Fig. 33—Pickup Arm Electronics



Player/Mechanism Control

Pla



- SCHEMATIC NOTES**
1. ALL RESISTORS 1/4W 5% UNLESS OTHERWISE SPECIFIED.
 2. RESISTANCE VALUES ARE IN OHMS, K=1000.
 3. CAPACITANCE VALUES GREATER THAN 10 ARE μ F. THOSE 10 OR LESS ARE nF UNLESS OTHERWISE SPECIFIED.
 4. ■ INDICATES SERVICE TEST POINT WITH STAKE.
 5. VOLTAGES SHOWN ARE MEASURED WITH AC INPUT OF 120V, NO SIGNAL APPLIED - PLAYER IN "LOAD" MODE. VOLTAGES SHOULD HOLD WITHIN 10%.
 6. WAVEFORMS SHOWN WERE TAKEN USING SIGNAL FROM SERVICE TEST DISC - SEGMENT "K" (STOCK NO. 153394).

All integrated circuits and many other semiconductors are electrostatically sensitive and therefore require the special handling techniques described under "Electrostatically Sensitive (ES) Devices" in the Servicing Precautions section of basic service data.

TRANSISTOR BASING ALL 5000 SERIES

PRODUCT SAFETY NOTE
 *SHADED COMPONENTS HAVE SPECIAL CHARACTERISTICS. IMPORTANT TO SAFETY. BEFORE REPLACING ANY OF THESE COMPONENTS READ CAREFULLY THE PRODUCT SAFETY NOTICE IN THIS SERVICE DATA. DO NOT DEGRADE THE SAFETY OF THE SET THROUGH IMPROPER SERVICING.

Player/Mechanism Control

Fig. 34—Player/Mechanism Control Electronics

1983 SJT 400 SCHEMATIC

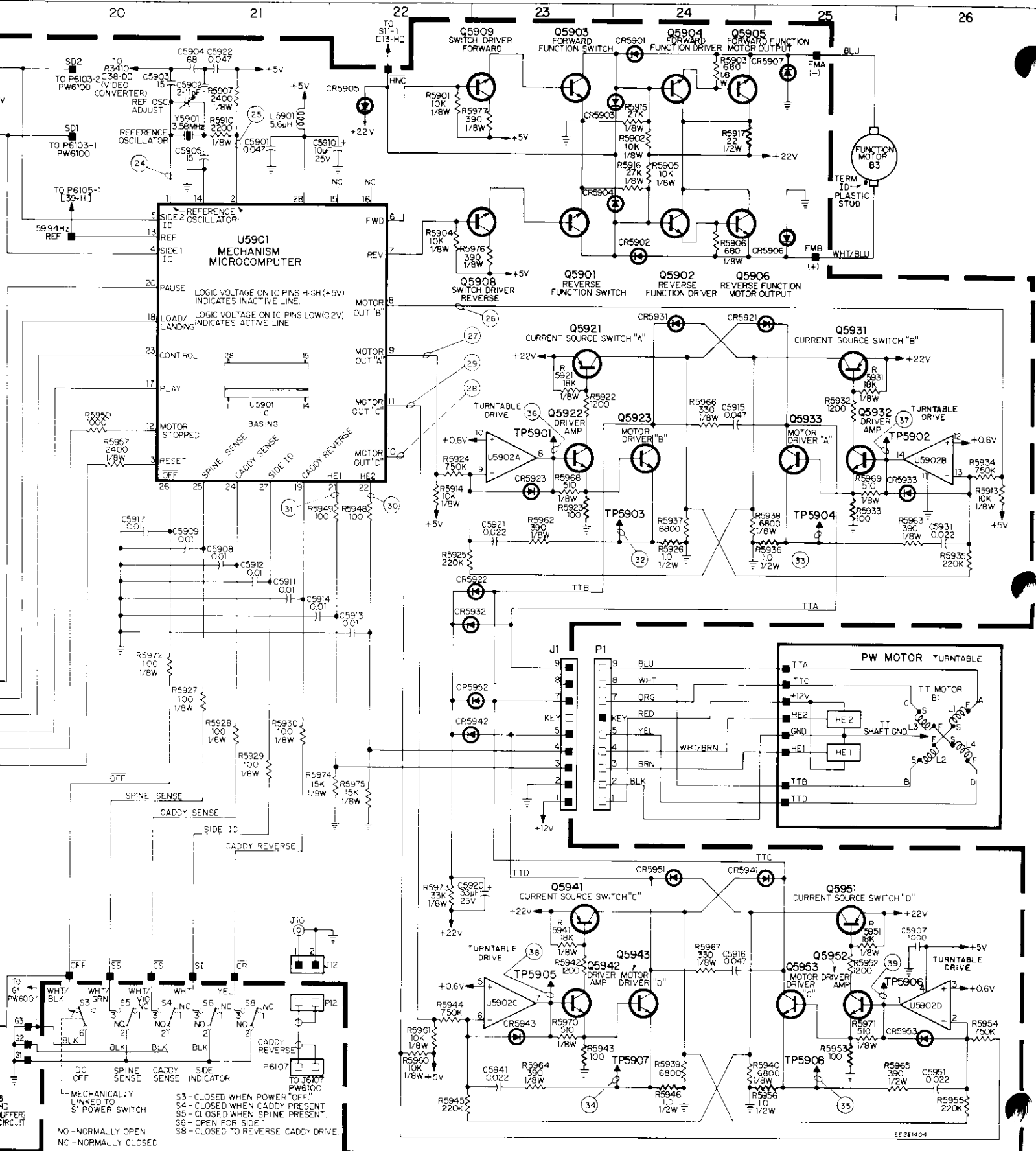

Player/Mechanism Control

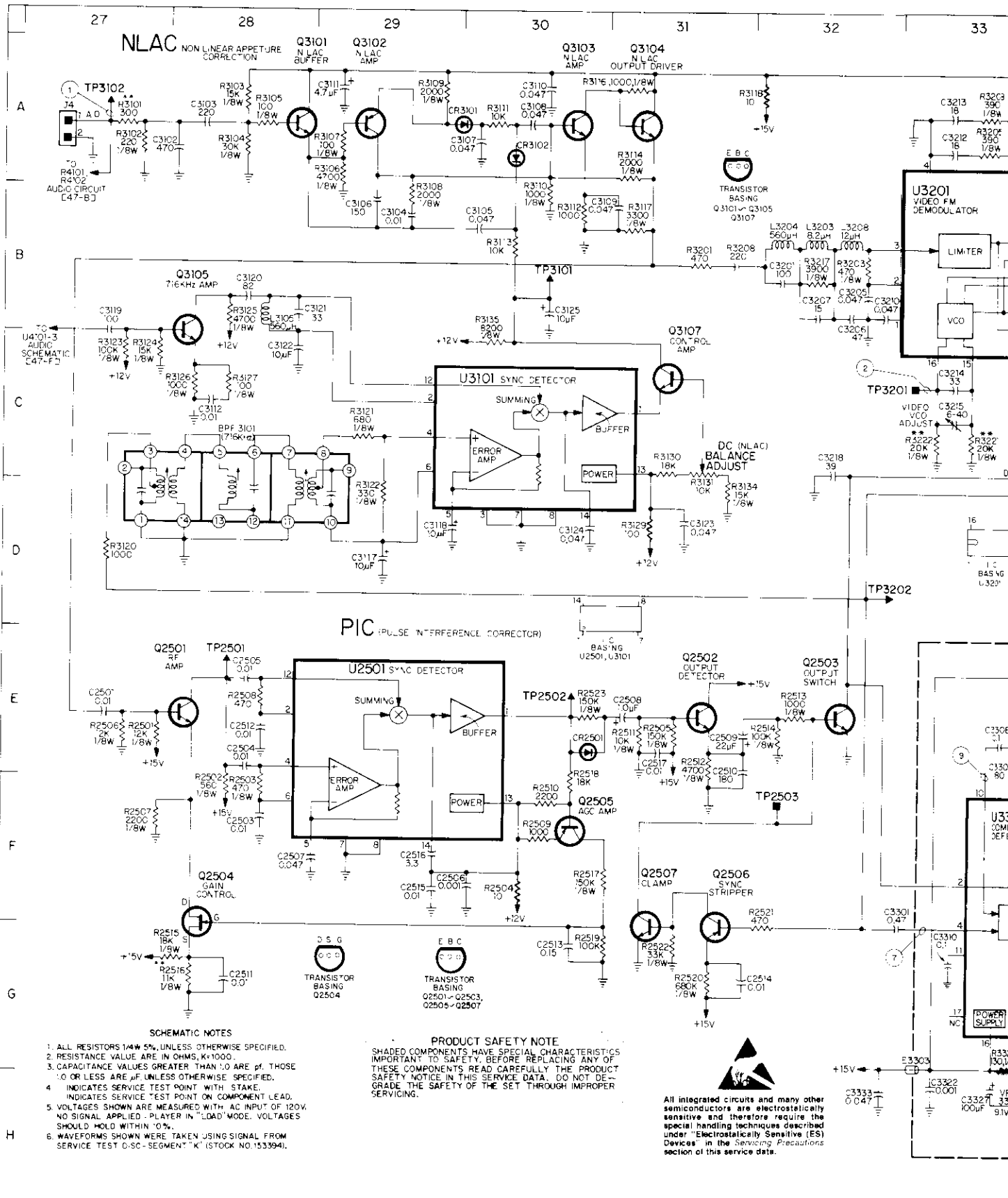

- SCHEMATIC NOTES**
1. ALL RESISTORS 1/4W 5%, UNLESS OTHERWISE SPECIFIED. RESISTANCE VALUE ARE IN OHMS, K=1000.
 2. CAPACITANCE VALUES GREATER THAN .01 ARE pF. THOSE .01 OR LESS ARE uF UNLESS OTHERWISE SPECIFIED.
 3. INDICATES SERVICE TEST POINT WITH STAKE.
 4. INDICATES SERVICE TEST POINT ON COMPONENT LEAD.
 5. VOLTAGES SHOWN ARE MEASURED WITH AC INPUT OF 120V. NO SIGNAL APPLIED. PLAYER IN "LOAD" MODE. VOLTAGES SHOULD HOLD WITHIN ±0%.
 6. WAVEFORMS SHOWN WERE TAKEN USING SIGNAL FROM SERVICE TEST D.S.C.-SEGMENT "K" (STOCK NO. 153394).

PRODUCT SAFETY NOTE
 SOME COMPONENTS HAVE SPECIAL CHARACTERISTICS IMPORTANT TO SAFETY. BEFORE REPLACING ANY OF THESE COMPONENTS READ CAREFULLY THE PRODUCT SAFETY NOTICE IN THIS SERVICE DATA. DO NOT DEGRADE THE SAFETY OF THE SET THROUGH IMPROPER SERVICING.

All integrated circuits and many other semiconductors are electrostatically sensitive and therefore require the special handling techniques described under "Electrostatically Sensitive (ES) Devices" in the Servicing Precautions section of this service data.

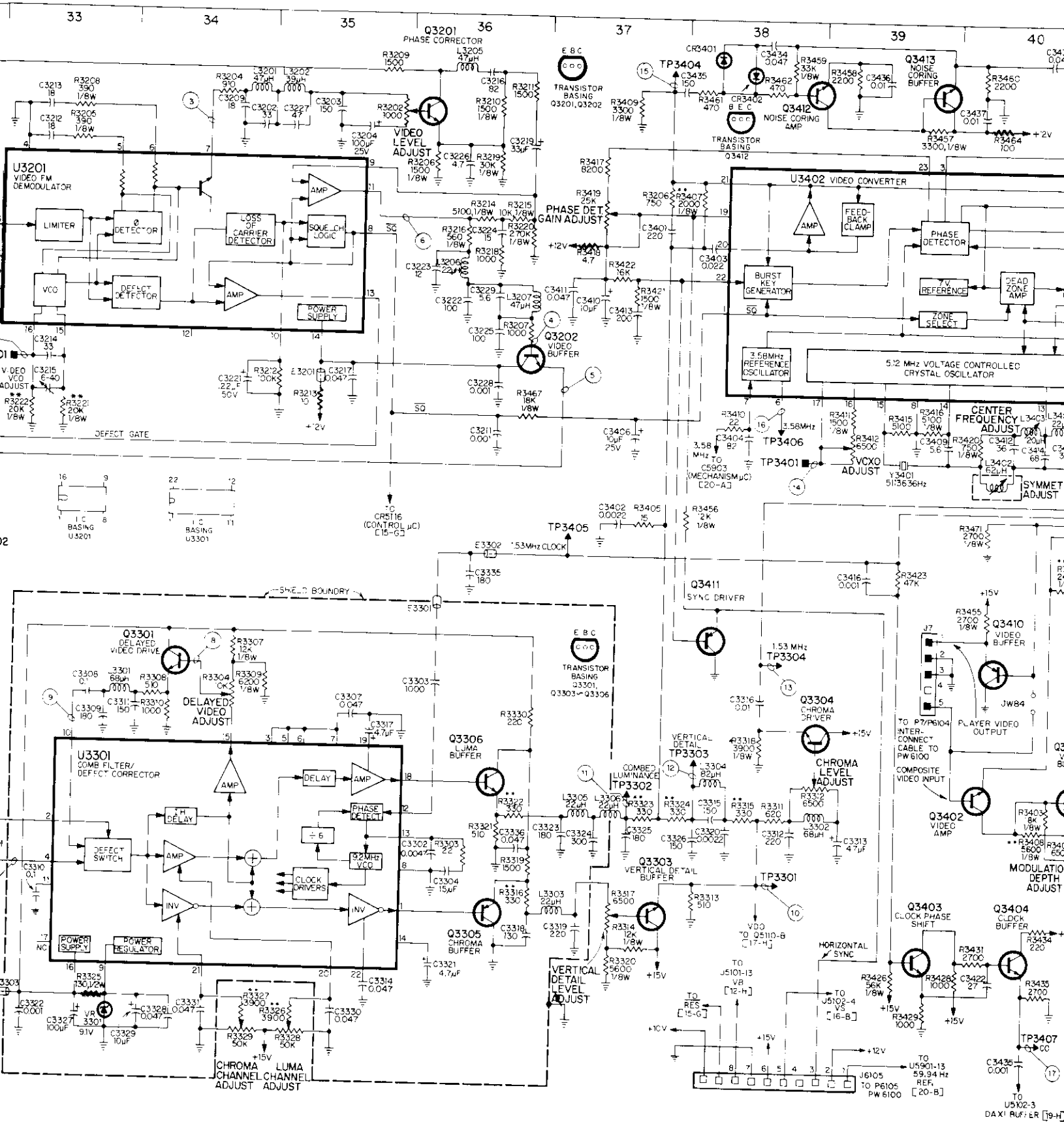
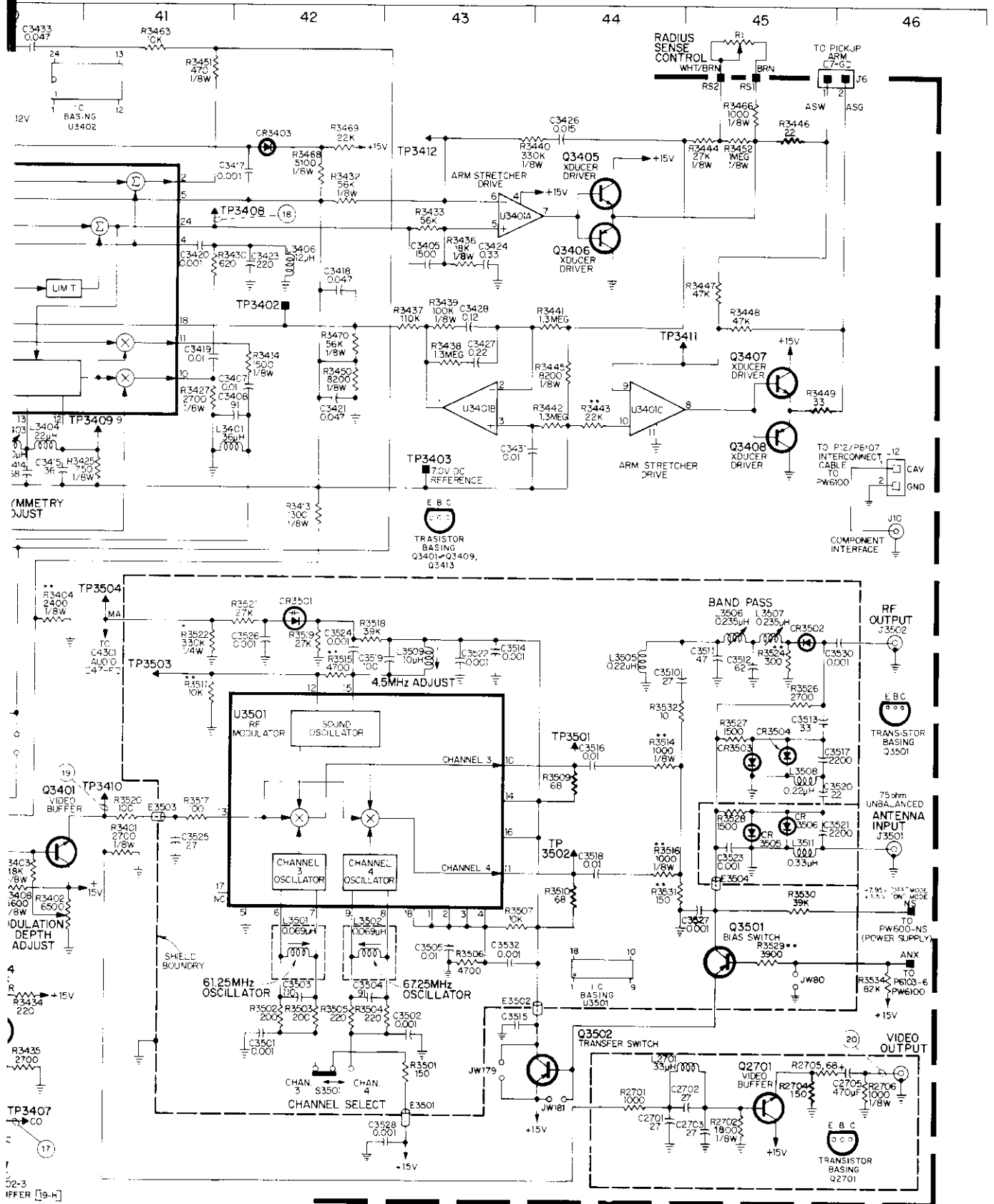

Fig. 35—Signal Processing Electronics



52-3
DIFFER [9-H]

FF251396-9

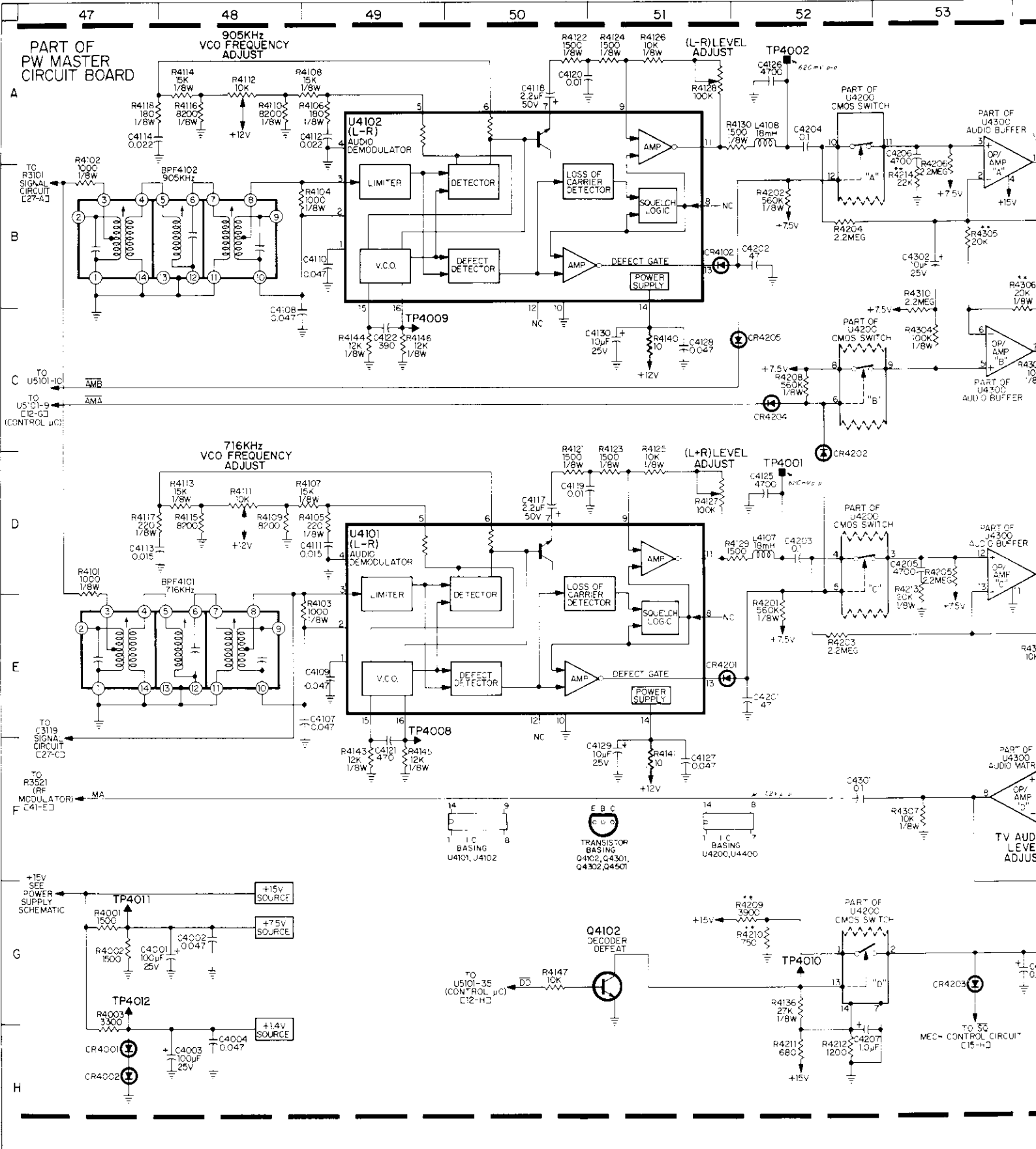
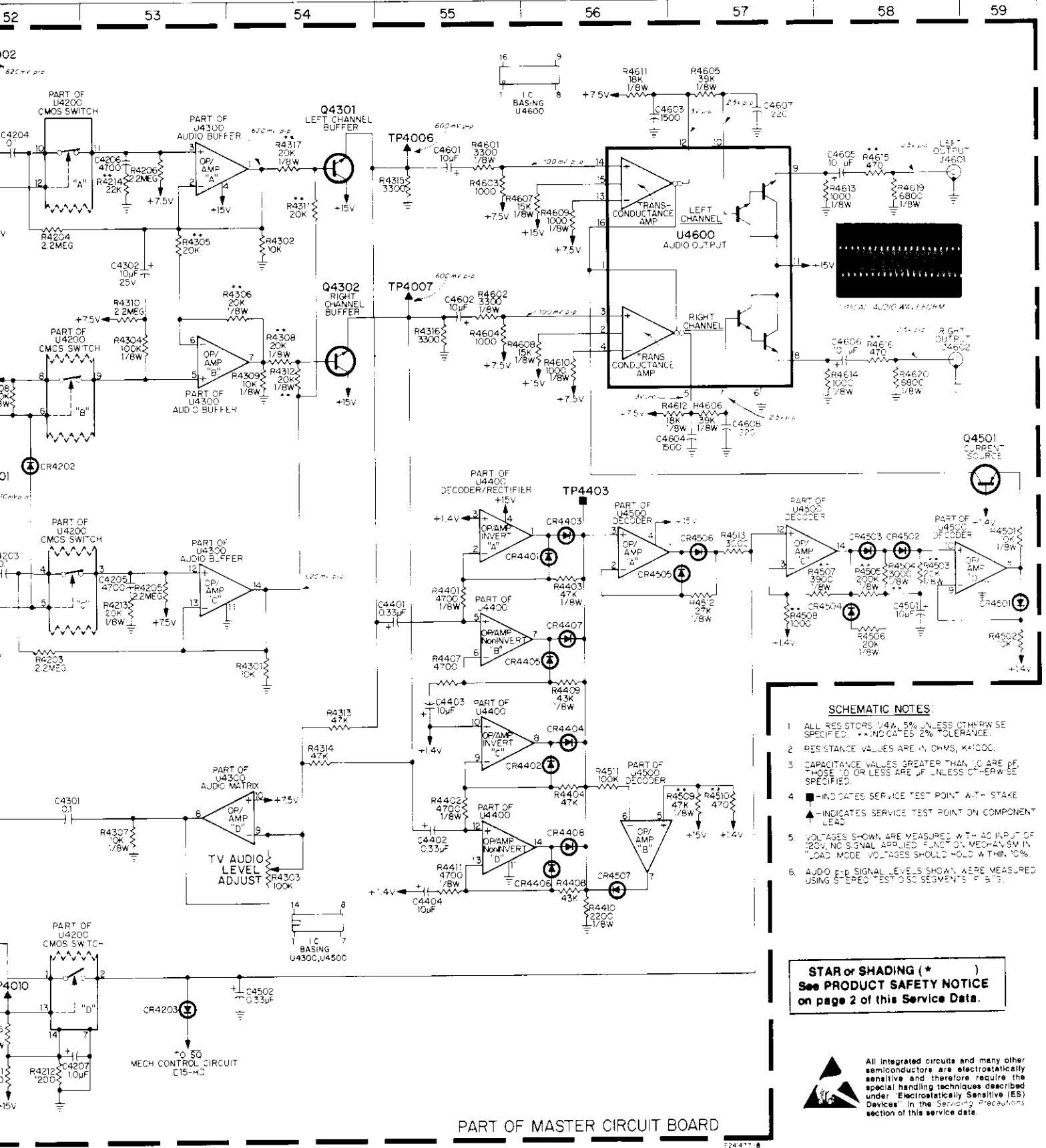

Fig. 36—Stereo Audio Electronics



SCHEMATIC NOTES:

1. ALL RESISTORS 1/4W, 5% UNLESS OTHERWISE SPECIFIED. TOLERANCES 2% UNLESS OTHERWISE SPECIFIED.
2. RESISTANCE VALUES ARE IN OHMS, K=1000.
3. CAPACITANCE VALUES GREATER THAN 10 ARE IN MICROFARADS, THOSE 10 OR LESS ARE IN PICOFARADS UNLESS OTHERWISE SPECIFIED.
4. ■ INDICATES SERVICE TEST POINT WITH STAKE
▲ INDICATES SERVICE TEST POINT ON COMPONENT LEAD
5. VOLTAGES SHOWN ARE MEASURED WITH AC INPUT OF 120V, NO SIGNAL APPLIED EXCEPT MECHANICAL IN "LOAD" MODE. VOLTAGES SHOULD HOLD WITHIN 10%.
6. AUDIO SIGNAL LEVELS SHOWN WERE MEASURED USING STEREO TEST TONE SEGMENTS F. 5.1.

STAR or SHADING (*)
See **PRODUCT SAFETY NOTICE**
on page 2 of this Service Data.



All integrated circuits and many other semiconductors are electrostatically sensitive and therefore require the special handling techniques described under "Electrostatically Sensitive (ES) Devices" in the Servicing Precautions section of this service data.

PART OF MASTER CIRCUIT BOARD

724477-8

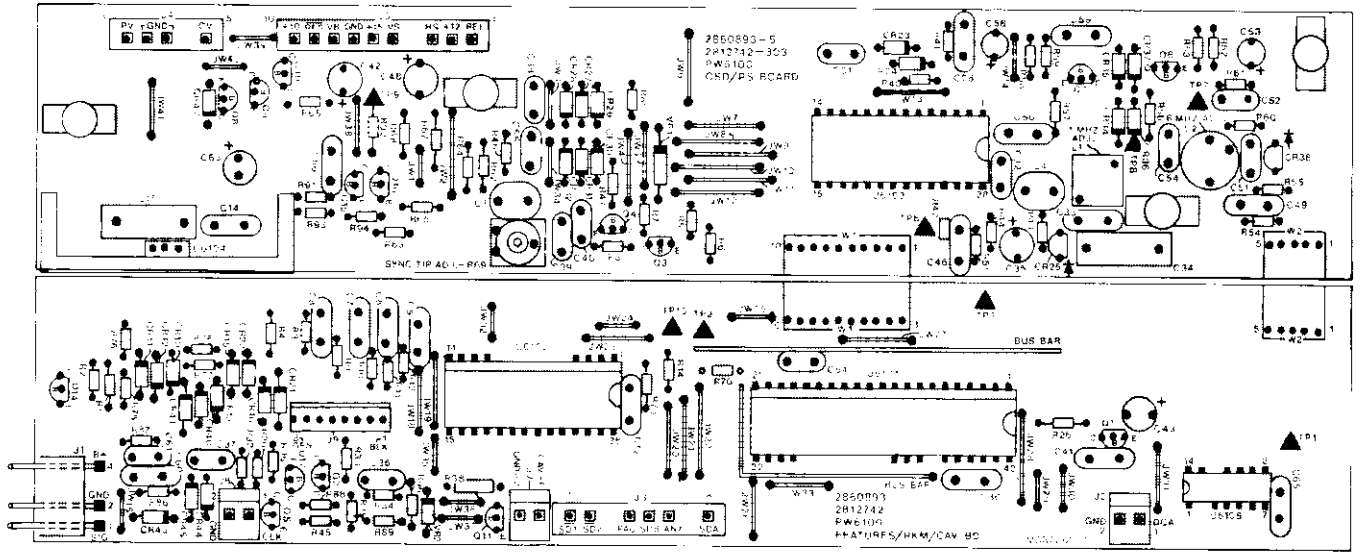

Fig. 37—PW6100 Circuit Board Assembly

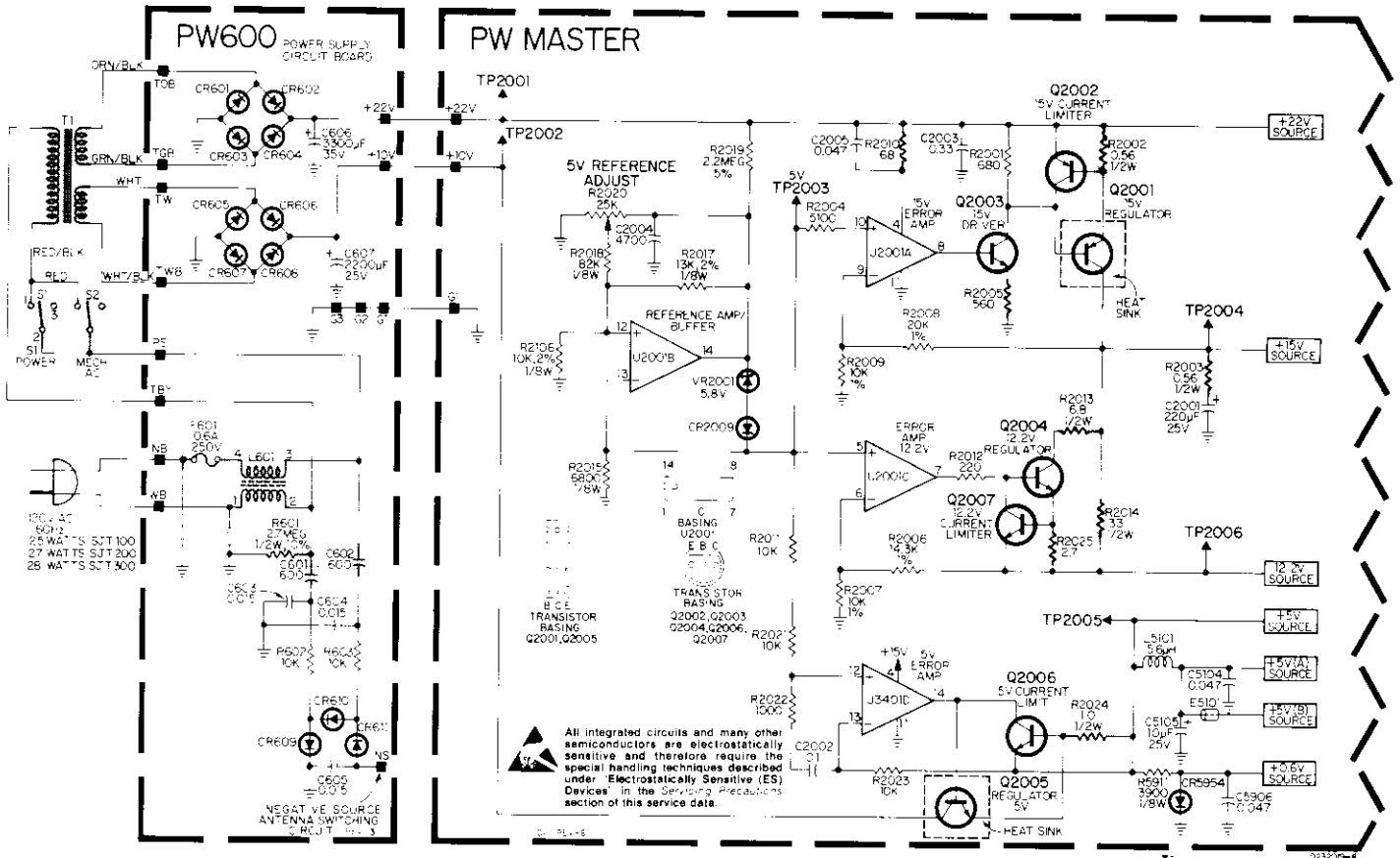

Fig. 38—Power Supply Electronics

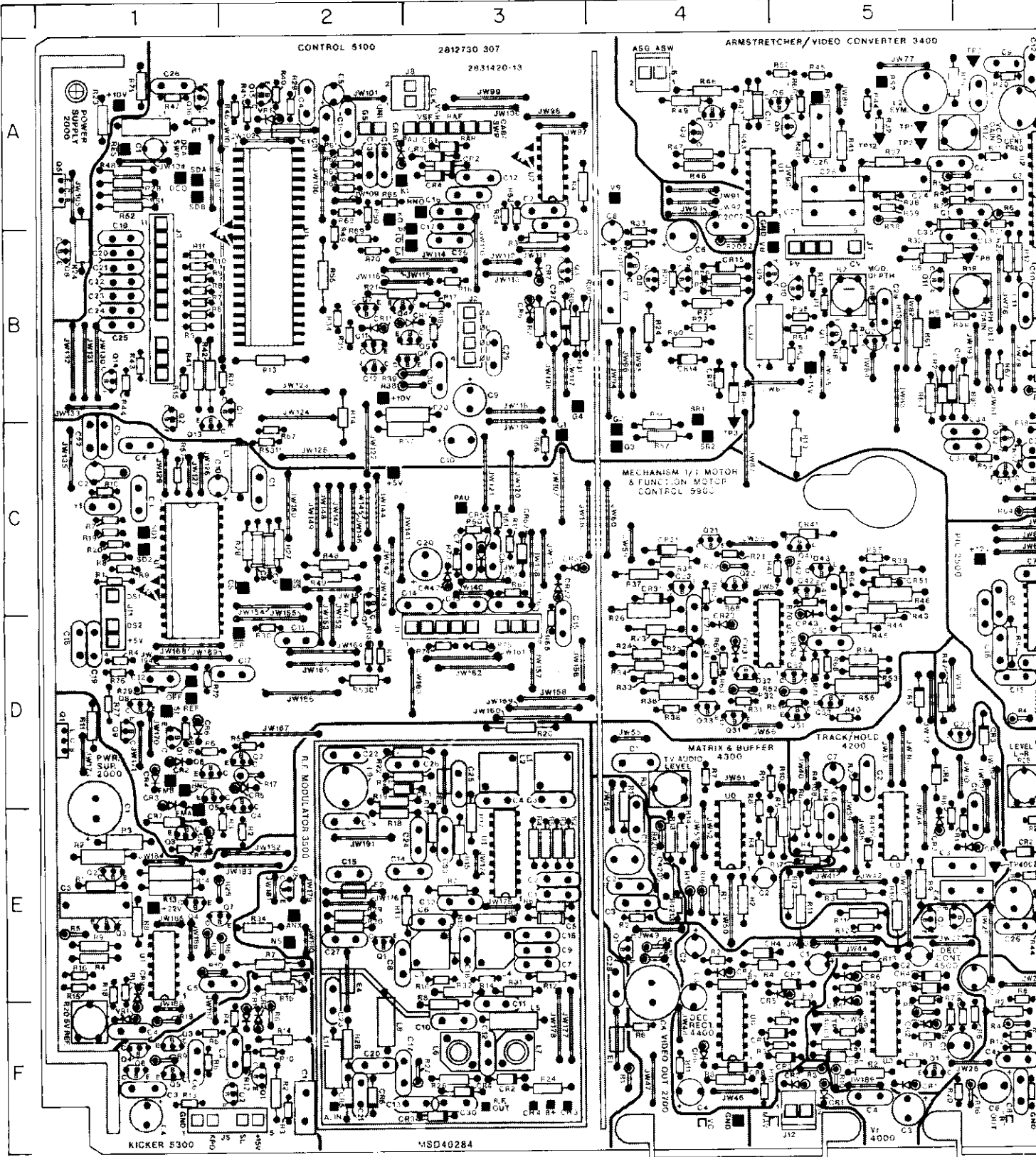
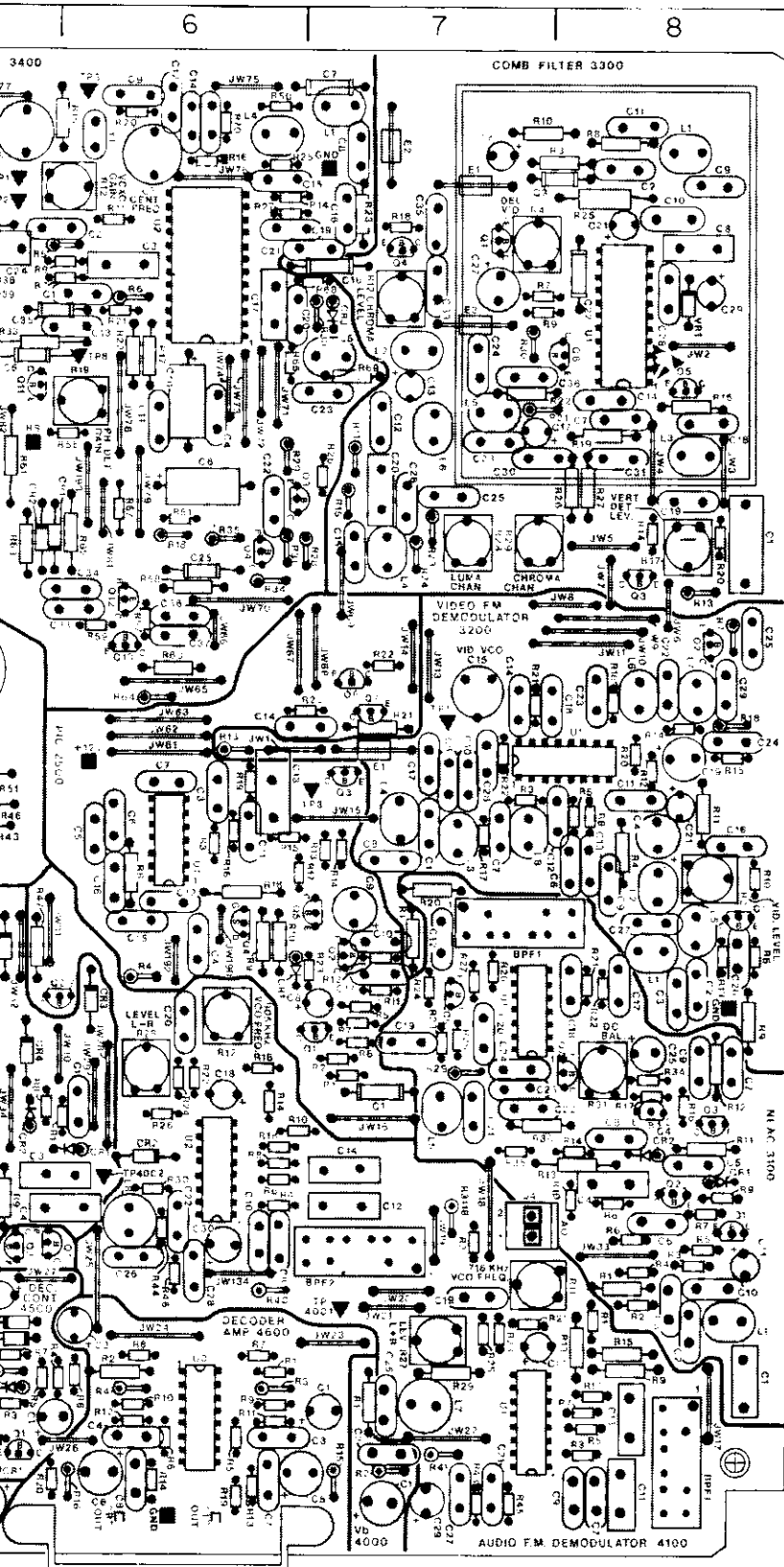

Fig. 39—PW Master Circuit Board Assembly

Component Location Guide



8PF3101	7D	C3309	8A	C3522	2D	C5301	2F	CR5906	1D
8PF4101	8F	C3310	8A	C3523	2F	C5302	2F	CR5907	1E
8PF4102	7E	C3311	8A	C3524	3E	C5303	1F	CR5921	4C
C2001	1D	C3312	7B	C3525	3D	C5304	1F	CR5922	3C
C2002	4A	C3313	7B	C3526	3E	C5306	1F	CR5923	4D
C2003	1E	C3314	8B	C3527	2E	C5901	2C	CR5931	4C
C2004	1F	C3315	7B	C3528	4E	C5902	1C	CR5932	3C
C2005	1C	C3316	7A	C3530	3F	C5903	1C	CR5933	4D
C2501	7D	C3317	7B	C3532	3E	C5904	1C	CR5941	5C
C2503	8C	C3318	8B	C3533	3E	C5905	1C	CR5942	3C
C2504	8D	C3319	8B	C4001	7F	C5906	3C	CR5943	5D
C2505	6D	C3320	7B	C4002	7F	C5907	3C	CR5951	5C
C2506	6C	C3321	8A	C4003	5F	C5908	2D	CR5952	3C
C2507	6C	C3322	8A	C4004	5F	C5909	2D	CR5953	5D
C2508	7D	C3323	7B	C4107	8F	C5910	1C	CR5954	3C
C2509	7D	C3324	7B	C4108	6E	C5911	2D	E3201	7C
C2510	7D	C3325	7B	C4109	8F	C5912	1D	E3301	7A
C2511	6D	C3326	7B	C4110	6E	C5913	3C	E3302	7A
C2512	6D	C3327	7A	C4111	8F	C5914	3C	E3303	7B
C2513	6C	C3328	8A	C4112	7E	C5915	3D	E3501	4F
C2514	6C	C3329	8A	C4113	8F	C5916	3C	E3502	2E
C2515	6D	C3330	7B	C4114	7E	C5917	2D	E3503	3D
C2516	6D	C3331	8B	C4117	7F	C5918	1D	E3504	2E
C2517	7D	C3333	7A	C4118	6E	C5919	1D	J1	3D
C2701	4E	C3335	7A	C4119	7E	C5920	3C	J2	3B
C2702	4E	C3336	7B	C4120	6D	C5921	4D	J3	1B
C2703	4E	C3401	6A	C4121	7F	C5922	1C	J4	7E
C2705	4F	C3402	6A	C4122	6E	C5931	4D	J5	1F
C3101	8F	C3403	6A	C4125	7F	C5941	4D	J6	4A
C3102	8E	C3404	6B	C4126	6E	C5951	4D	J7	5B
C3103	8E	C3405	5B	C4127	7F	CR2009	1E	J8	3A
C3104	8E	C3406	6E	C4128	6E	CR2501	6D	J9	1A
C3105	8E	C3407	7A	C4129	7F	CR3101	8E	J11	1C
C3106	8E	C3408	7A	C4130	6E	CR3102	8E	J12	5F
C3107	8D	C3409	6A	C4201	6E	CR3401	5B	E5101	2A
C3108	8E	C3410	6B	C4202	5D	CR3402	5B	L2701	4E
C3109	8D	C3411	6B	C4203	5E	CR3403	7B	L3101	8F
C3110	8E	C3412	6A	C4204	5E	CR3501	2D	L3105	7E
C3111	8E	C3413	6B	C4205	4E	CR3502	3F	L3201	8D
C3112	7D	C3414	6A	C4206	5E	CR3503	3F	L3202	8D
C3117	8D	C3415	6A	C4207	5D	CR3504	3F	L3203	7D
C3118	8D	C3416	7A	C4301	4D	CR3505	2F	L3204	7C
C3119	7D	C3417	6B	C4302	4E	CR3506	2F	L3205	8D
C3120	7D	C3418	6A	C4401	5E	CR4001	5F	L3206	8C
C3121	7E	C3419	6A	C4402	4E	CR4002	5F	L3207	8C
C3122	7E	C3420	6B	C4403	4E	CR4102	6E	L3208	7D
C3123	7D	C3421	6A	C4404	4F	CR4201	6E	L3301	8A
C3124	7D	C3422	6B	C4501	5F	CR4202	5E	L3302	7B
C3125	8D	C3423	7B	C4502	5E	CR4203	6D	L3303	8B
C3201	7C	C3424	5A	C4601	7F	CR4204	5D	L3304	7B
C3202	8D	C3425	8B	C4602	6E	CR4205	5D	L3305	7B
C3203	8D	C3426	5A	C4603	6F	CR4401	5F	L3306	7B
C3204	8C	C3427	5A	C4604	6F	CR4402	4E	L3401	7A
C3205	7C	C3428	5A	C4605	6F	CR4403	5F	L3402	5A
C3206	8D	C3429	5B	C4606	6F	CR4404	4E	L3403	6A
C3207	7D	C3431	4A	C4607	6F	CR4405	5E	L3404	6A
C3208	7D	C3432	4B	C4608	6F	CR4406	4F	L3405	7B
C3209	8D	C3433	6C	C5101	1A	CR4407	5E	L3501	3D
C3210	7C	C3434	6C	C5102	3A	CR4408	4F	L3502	3D
C3211	8C	C3435	5B	C5103	3B	CR4501	5F	L3503	3E
C3212	8C	C3436	6C	C5104	2A	CR4502	5F	L3504	3E
C3213	8D	C3437	6C	C5105	2A	CR4503	5E	L3505	3F
C3214	7C	C3501	3E	C5106	4B	CR4504	5E	L3506	3F
C3215	7C	C3502	3E	C5107	4B	CR4505	5F	L3507	3F
C3216	8D	C3503	3D	C5108	4B	CR4506	5E	L3508	2F
C3217	7C	C3504	3D	C5109	3B	CR4507	5F	L3509	2D
C3218	8C	C3505	3E	C5110	3C	CR5106	3B	L3511	2F
C3219	8C	C3506	3E	C5111	3A	CR5107	3B	L4107	7F
C3221	8C	C3507	3E	C5114	2A	CR5108	3B	L4108	6E
C3222	8C	C3508	2E	C5116	3A	CR5110	2A	L5101	1A
C3223	8C	C3509	3E	C5117	3A	CR5111	2B	L5901	2C
C3224	8C	C3510	3F	C5119	1B	CR5112	3B	Q2001	1D
C3225	8C	C3511	3F	C5120	1B	CR5114	4B	Q2002	1E
C3226	8D	C3512	3F	C5121	1B	CR5115	4B	Q2003	1E
C3227	8D	C3513	2F	C5122	1B	CR5116	4B	Q2004	1E
C3228	7C	C3514	2E	C5123	1B	CR5117	4B	Q2005	1A
C3229	8C	C3515	2E	C5124	1B	CR5301	2F	Q2006	1B
C3301	8B	C3516	3E	C5125	1B	CR5302	2F	Q2007	1E
C3302	8A	C3517	2F	C5126	3B	CR5901	1E	Q2501	7D
C3303	7A	C3518	3E	C5127	3B	CR5902	1D	Q2502	7D
C3304	7A	C3519	2E	C5128	1A	CR5903	1D	Q2503	7C
C3307	8B	C3520	2F	C5129	3B	CR5904	1D	Q2504	6D
C3308	8A	C3521	2F	C5130	3B	CR5905	2D	Q2505	7D

NOTE: SEE INTERCONNECT WIRING DIAGRAM FOR EXTERNAL CONNECTIONS

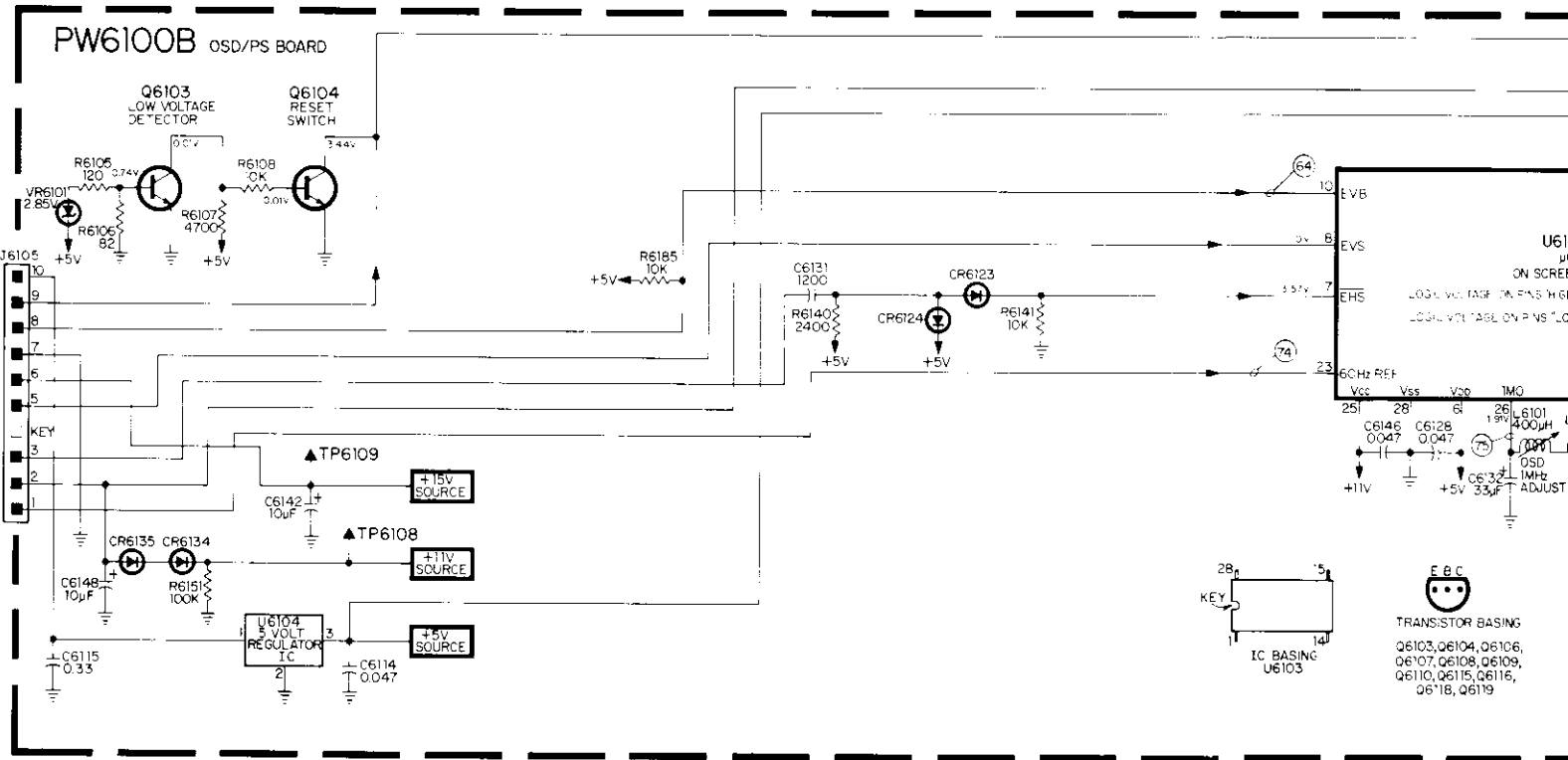
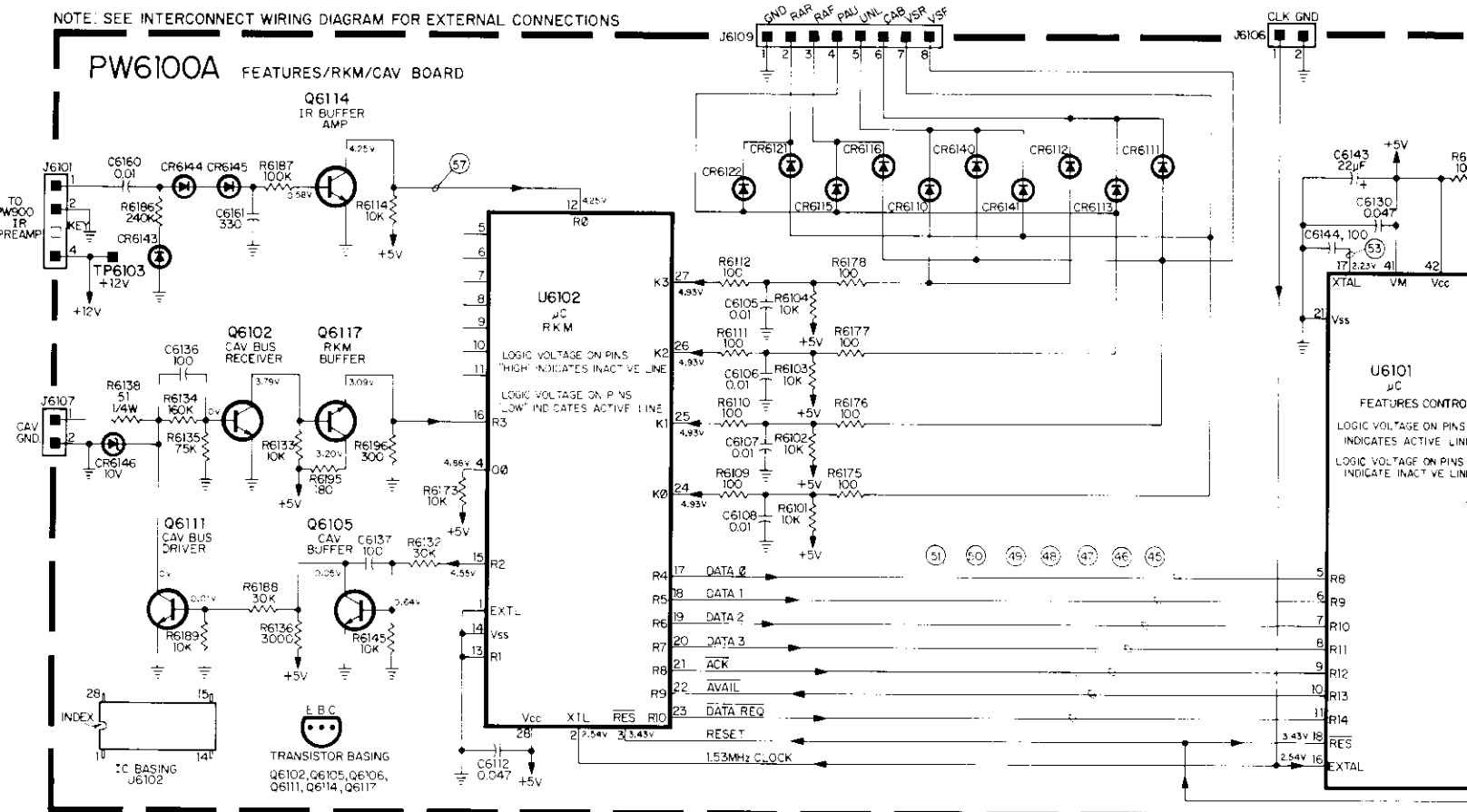

Fig. 40—PW6100 RKM/Features/OSD Schem

SCHMATIC NOTES:

1. ALL RESISTORS 1/8W 5%, UNLESS OTHERWISE SPECIFIED.
2. RESISTANCE VALUES ARE IN OHMS, K=1000.
3. CAPACITANCE VALUES GREATER THAN 10 ARE IN PF THOSE 10 OR LESS ARE μ F, UNLESS OTHERWISE SPECIFIED.
4. \blacksquare INDICATES SERVICE TEST POINT WITH STAKE
 \blacktriangledown INDICATES SERVICE TEST POINT ON COMPONENT LEAD.
5. VOLTAGES AND WAVEFORMS TAKEN WITH PLAYER IN "LOAD" MODE.



All integrated circuits and many other semiconductors are electrostatically sensitive and therefore require the special handling techniques described under "Electrostatically Sensitive (ES) Devices" in the Servicing Precautions section of basic service data.

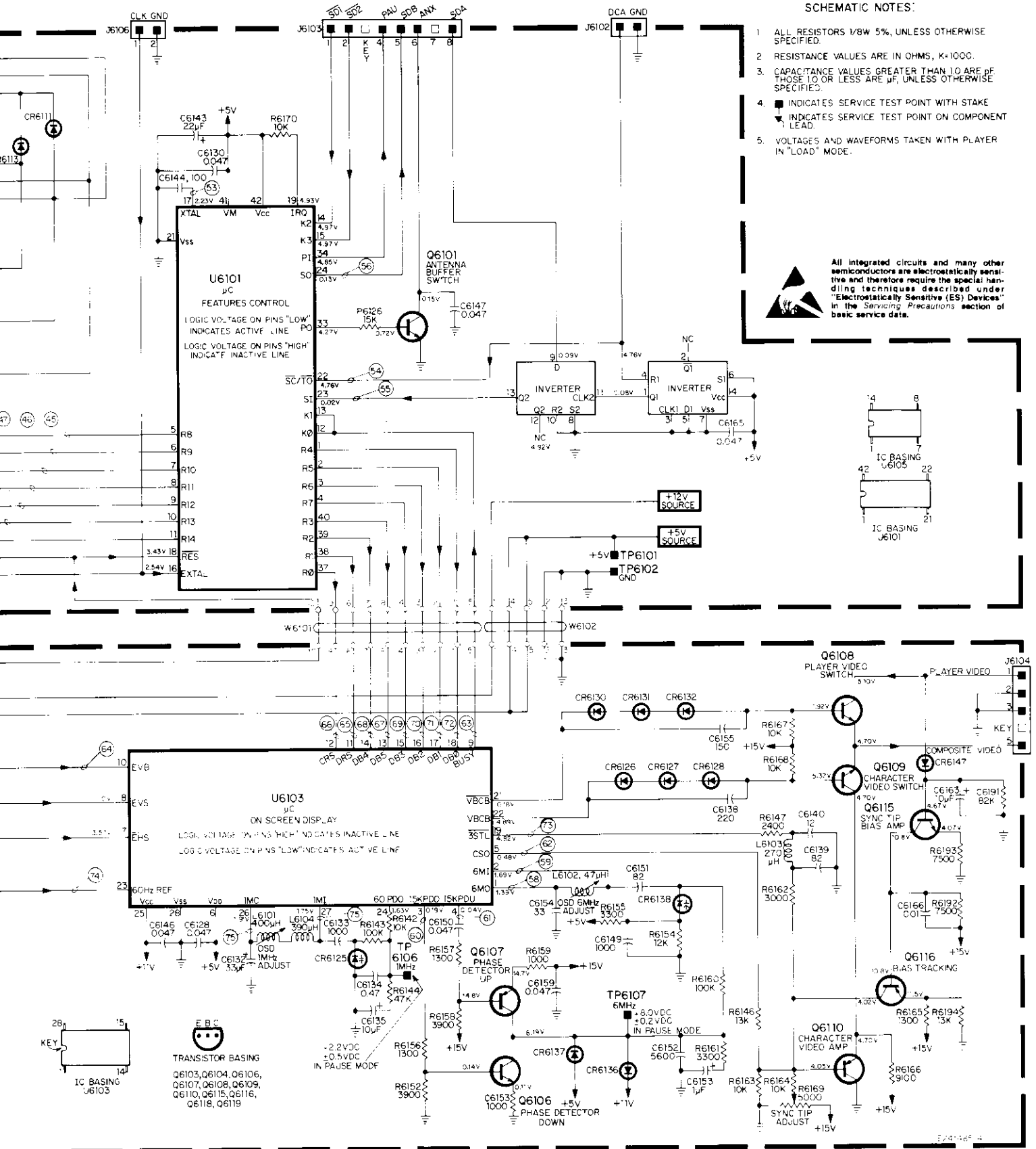

TRANSISTOR BASING
 Q6103, Q6104, Q6106, Q6107, Q6108, Q6109, Q6110, Q6115, Q6116, Q6118, Q6119

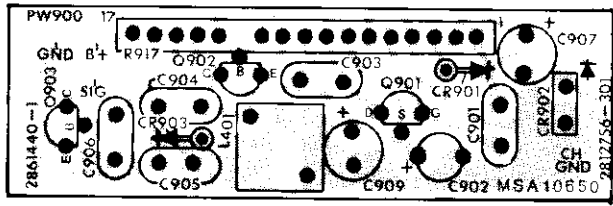

NOTE: Add 900 Series Prefix to Item Numbers

Fig. 41—PW 900 Circuit Board Assembly (SJT 300)

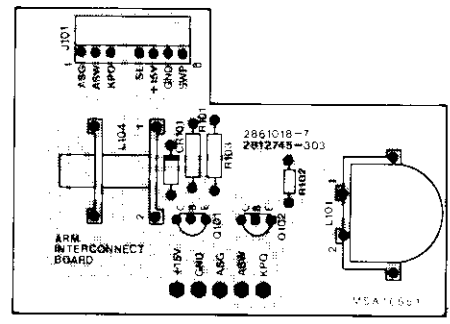
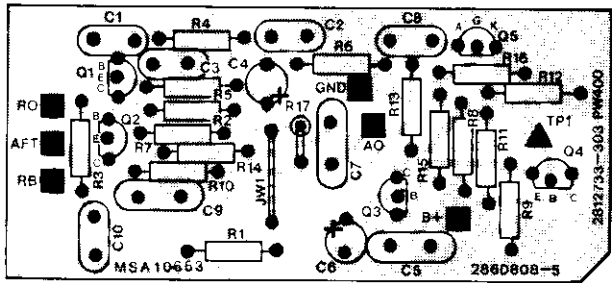
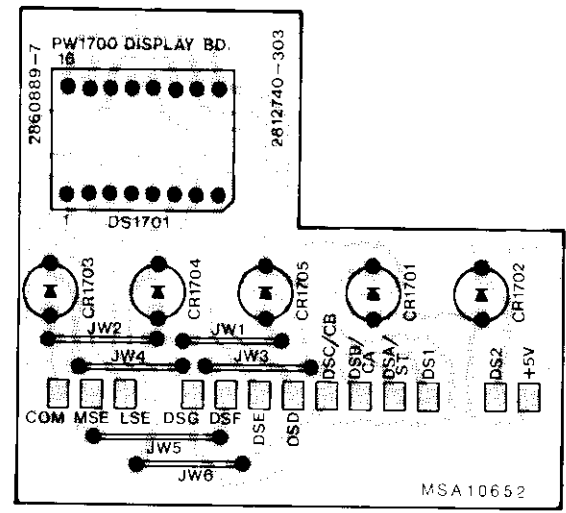

Fig. 42—PW Arm Interconnect Circuit Board Assembly



NOTE: Add 400 Series Prefix to Item Numbers

Fig. 43—PW 400 Circuit Board Assembly



NOTE: Add 1700 Series Prefix to Item Numbers

Fig. 44—PW 1700 Circuit Board Assembly

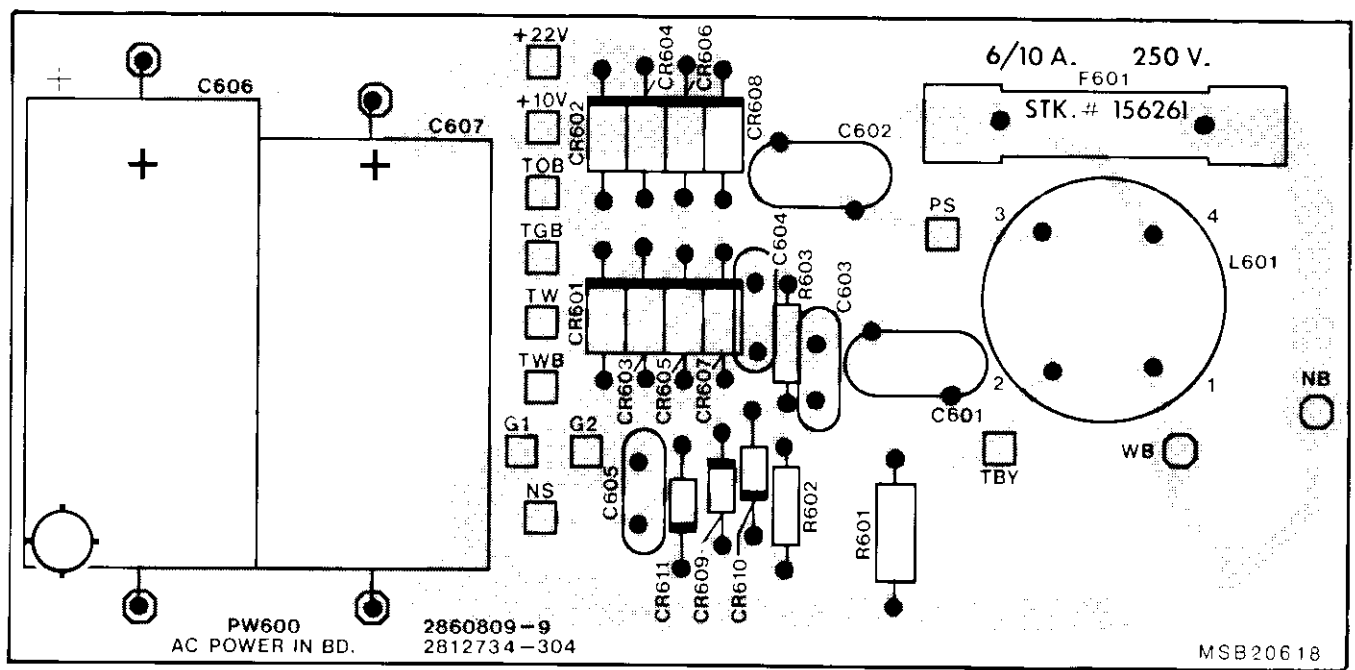

NOTE: Add 600 Series Prefix to Item Numbers

Fig. 45—PW 600 Circuit Board Assembly

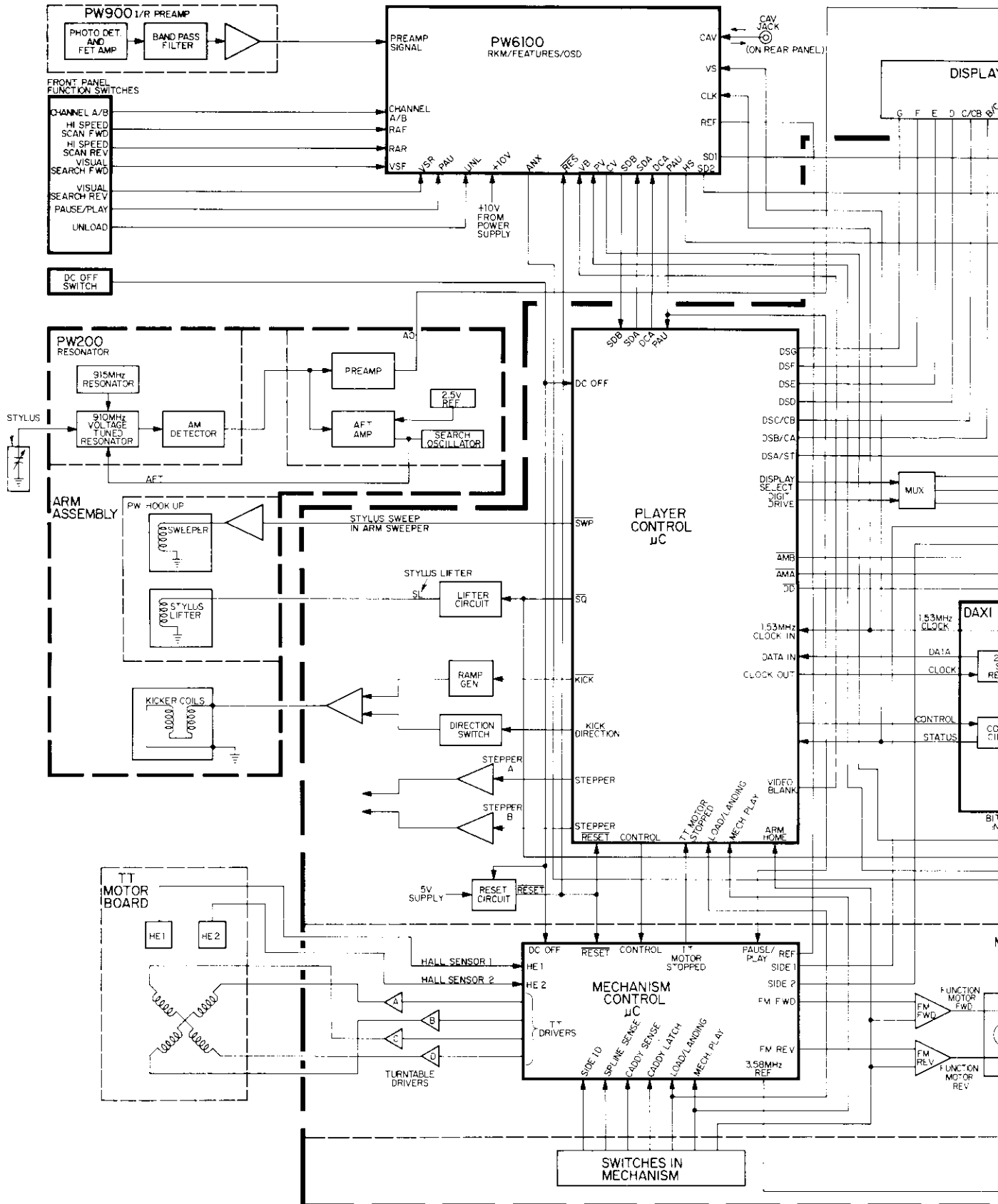

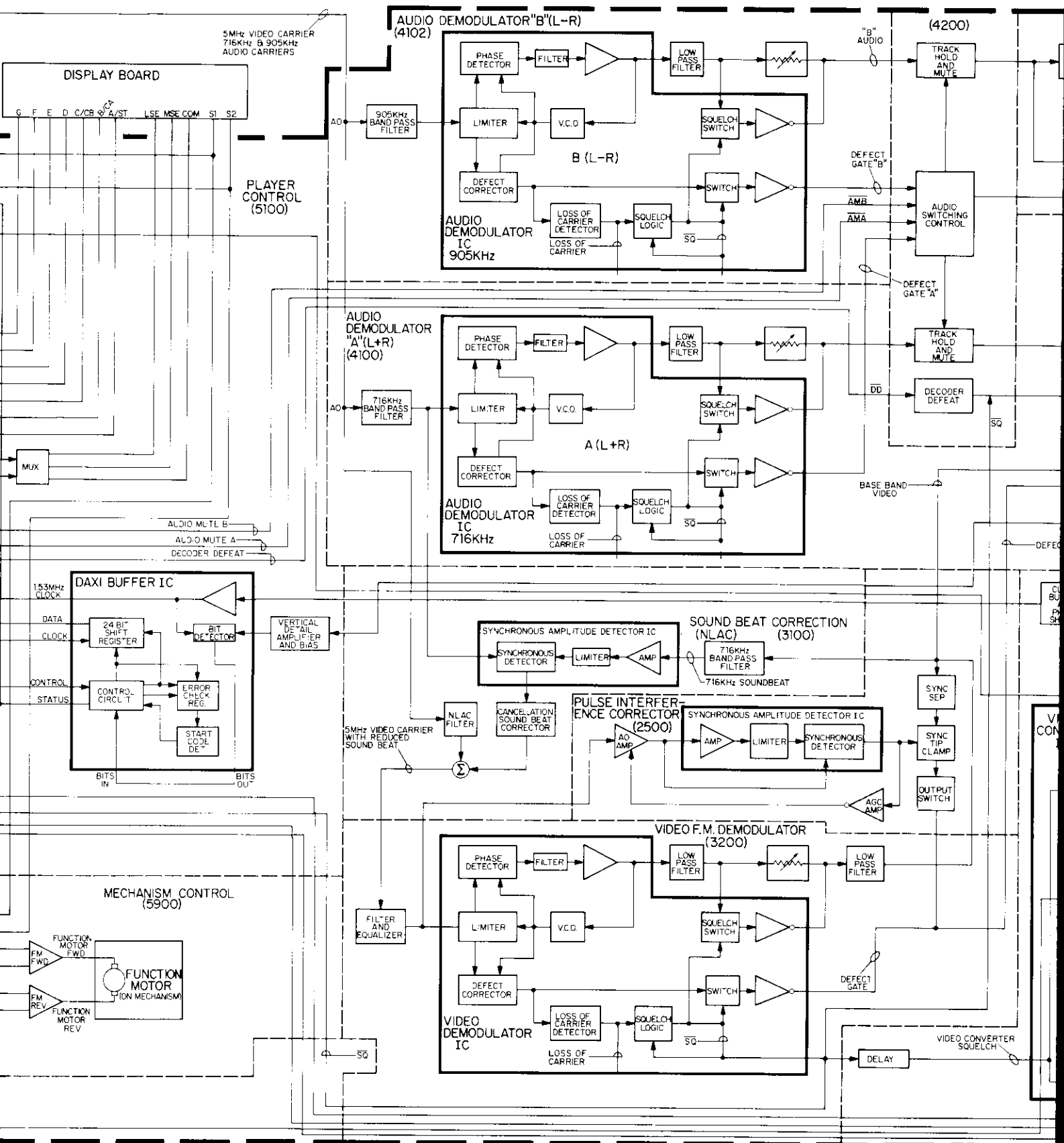
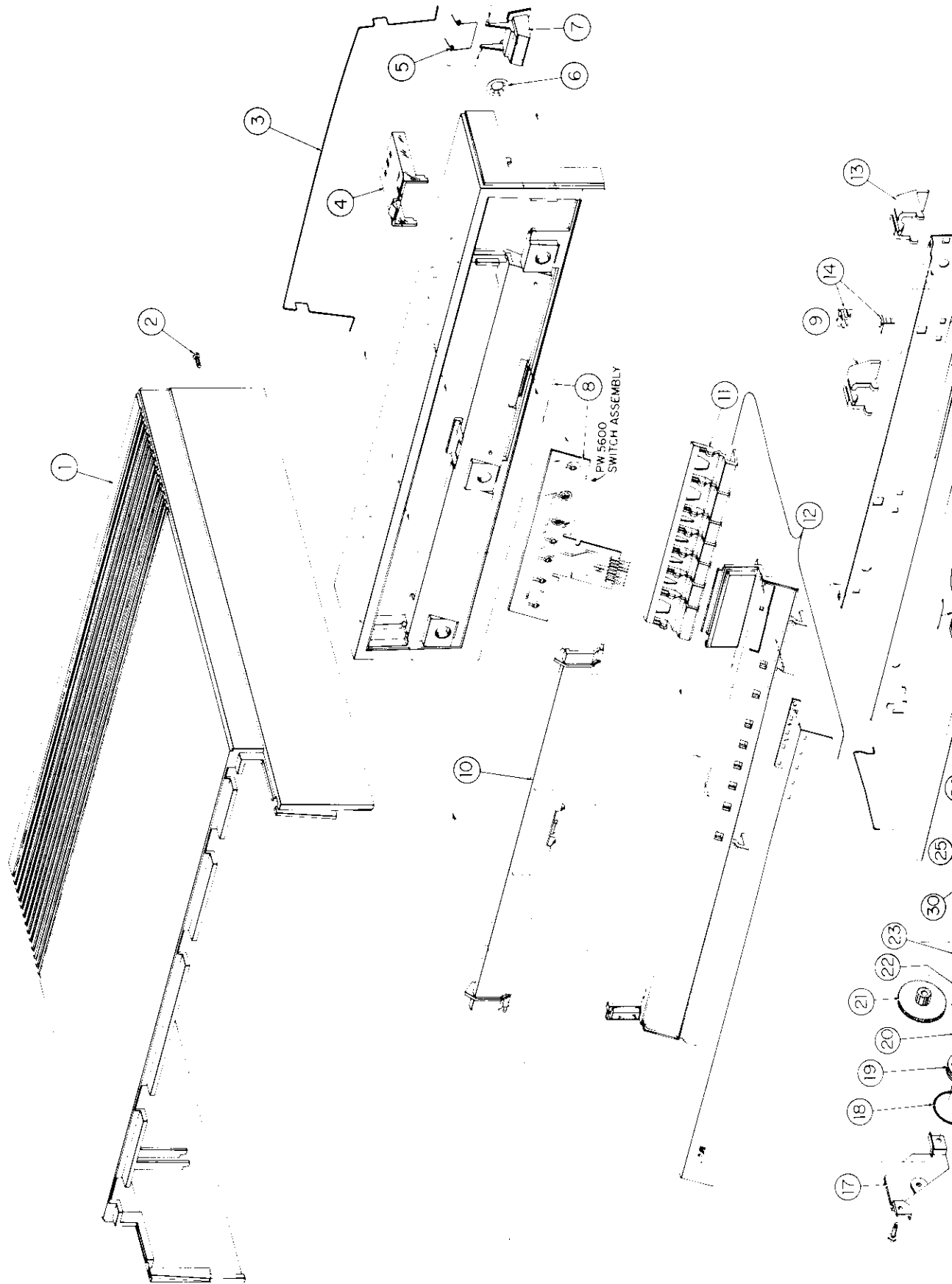
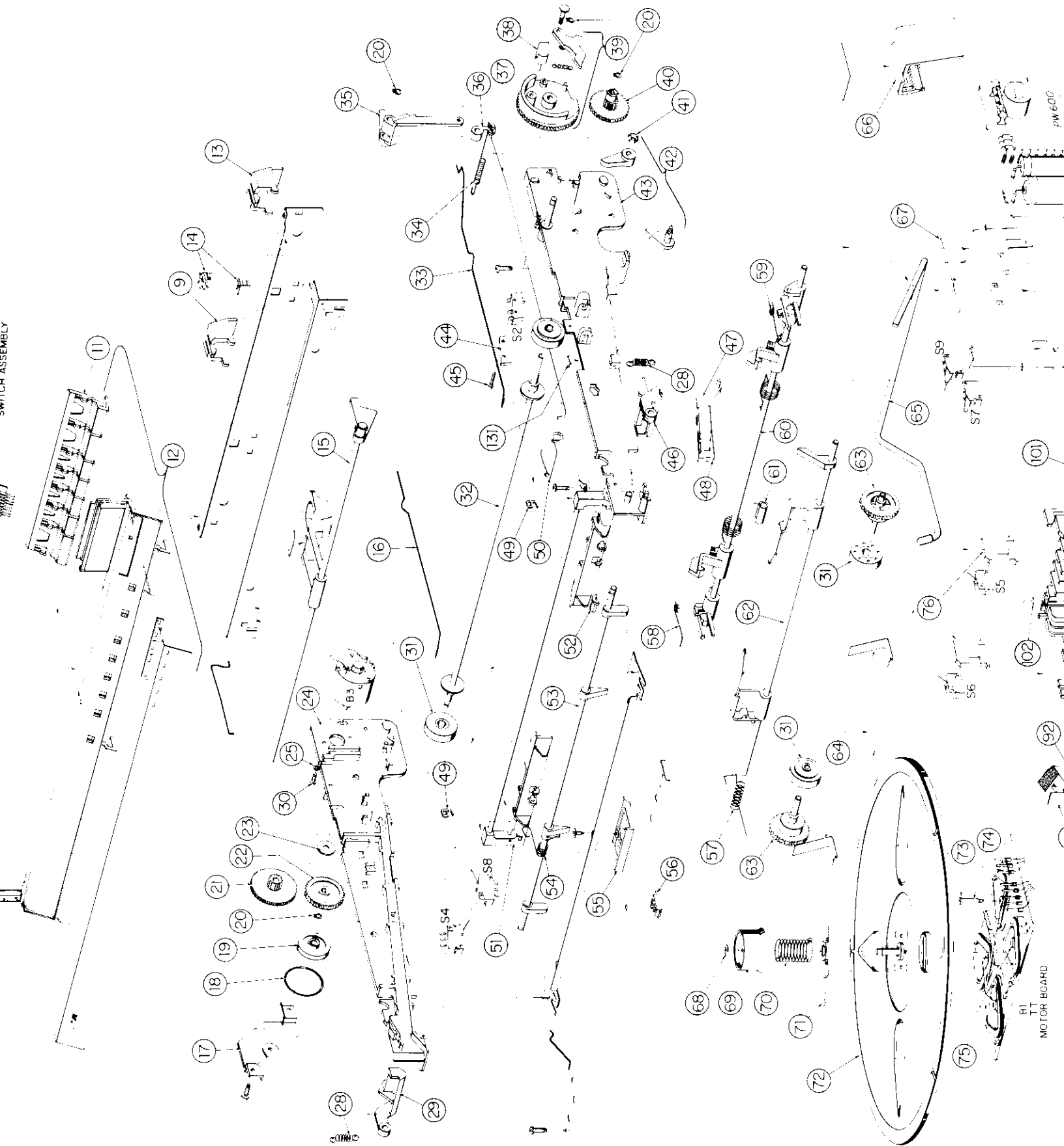

Fig. 46—Functional Block Diagram

EXPLODED VIEW



SWITCH ASSEMBLY



BL
MOTOR BOARD

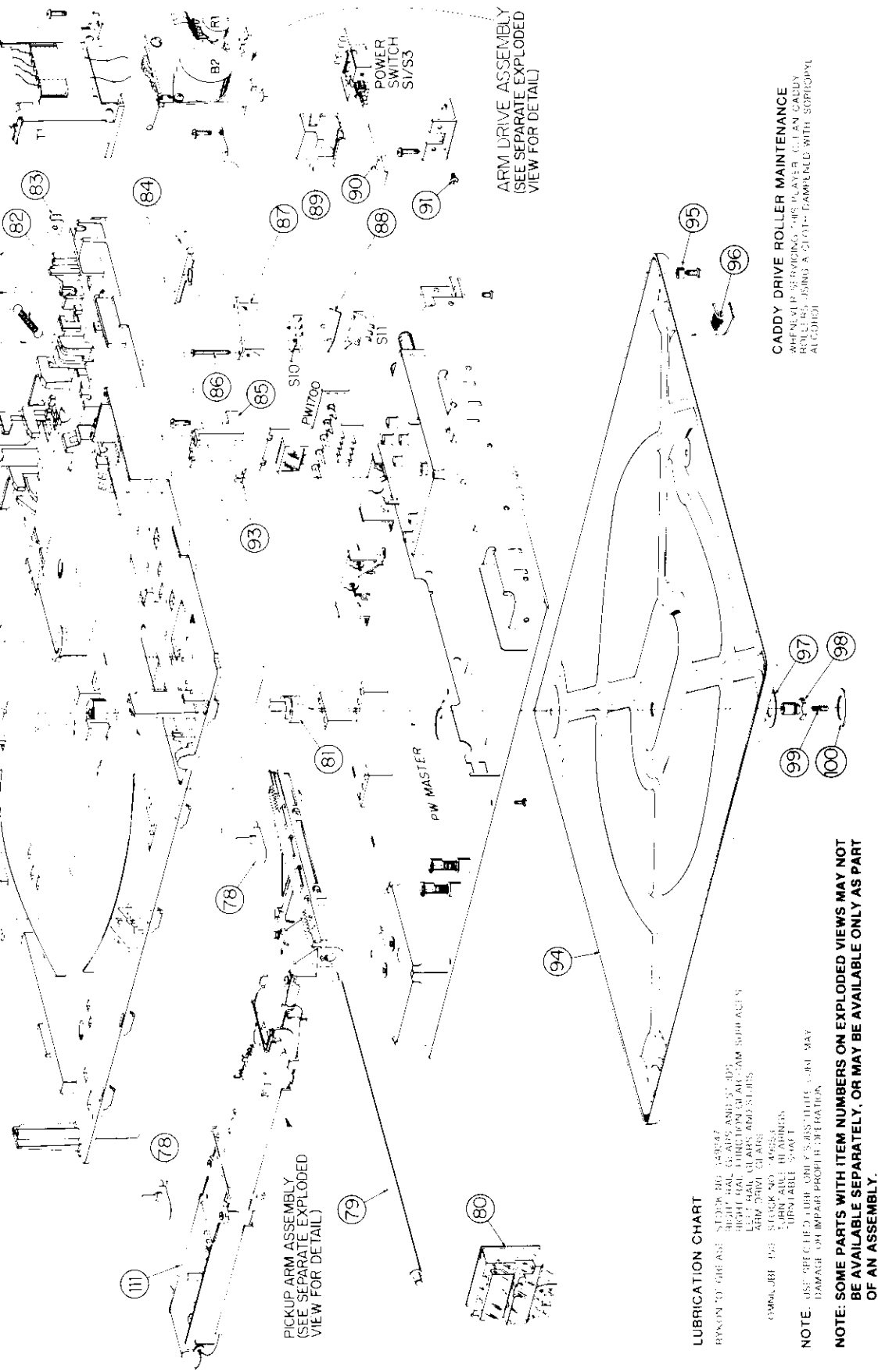

ARM DRIVE ASSEMBLY
(SEE SEPARATE EXPLODED
VIEW FOR DETAIL)

CADDY DRIVE ROLLER MAINTENANCE
WHEN PERFORMING THIS PLAYER CLEAN CADDY
ROLLERS USING A DUST-DAMPENED WITH ISOPROPYL
ALCOHOL

LUBRICATION CHART

- RYNDOR TO THE ASE
- SEWER SET TARGET
- RIGHT HALL GEAR AND S. 105
- LEFT HALL GEAR AND S. 105
- LEFT HALL GEAR AND S. 105
- ARM DRIVE GEAR
- STOCK NO. 49925
- TURNABLE BEARINGS
- TURNABLE SHAFT

NOTE: USE SPECIFIED LUB ONLY EXCESS LUBE COULD CAUSE
DAMAGE OR IMPAIR PROPER OPERATION

NOTE: SOME PARTS WITH ITEM NUMBERS ON EXPLODED VIEWS MAY NOT
BE AVAILABLE SEPARATELY, OR MAY BE AVAILABLE ONLY AS PART
OF AN ASSEMBLY.

Fig. 47—Cabinet and Player Mechanism

EXPLODED VIEW

NOTE: SOME PARTS WITH ITEM NUMBERS ON EXPLODED VIEWS MAY NOT BE AVAILABLE SEPERATELY, OR MAY BE AVAILABLE ONLY AS PART OF AN ASSEMBLY.

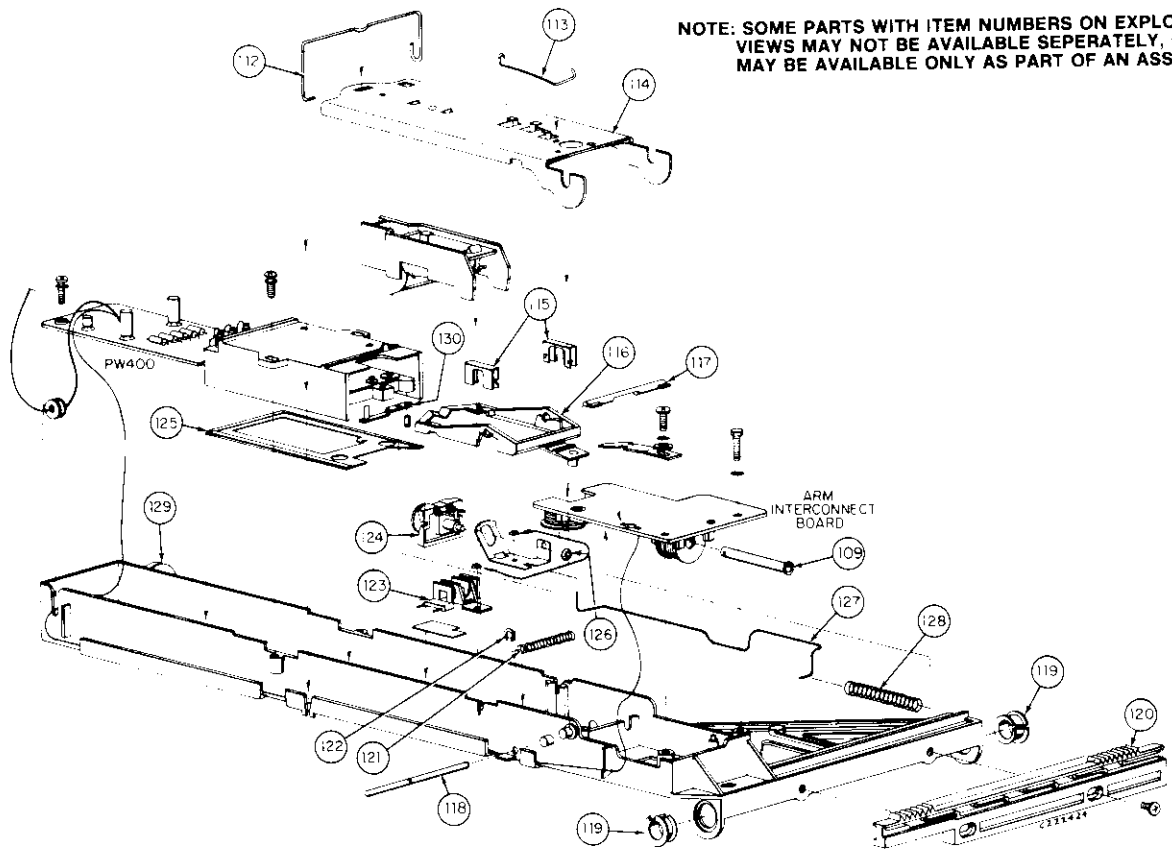

Fig. 48—Arm Assembly

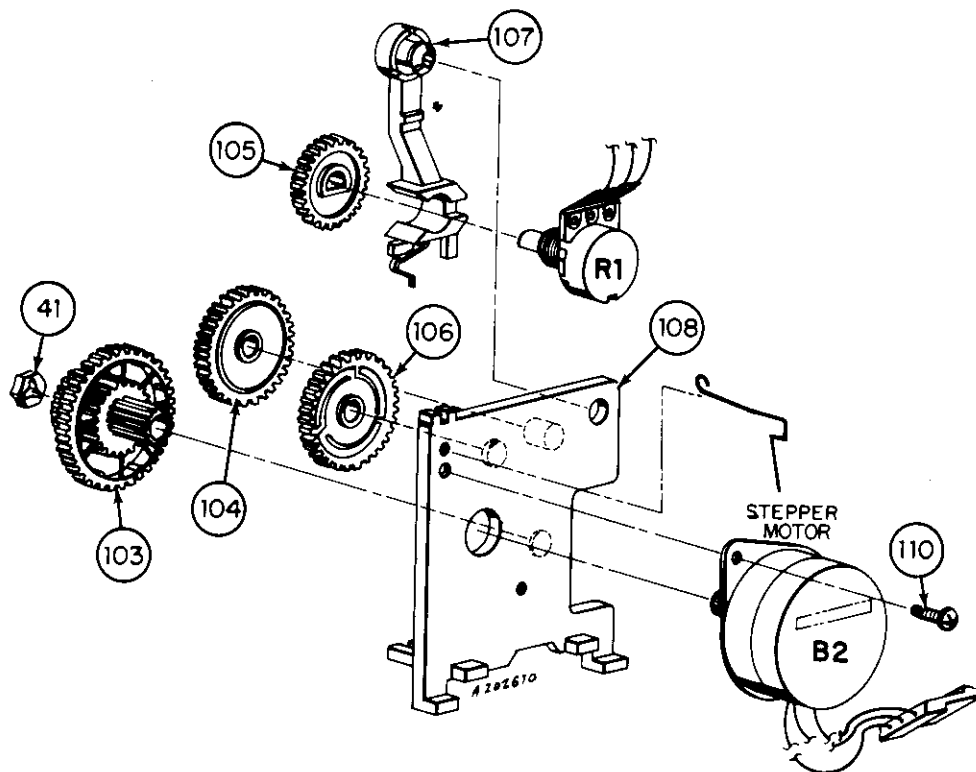

Fig. 49—Arm Drive Assembly



All integrated circuits and many other semiconductors are electrostatically sensitive and therefore require the special handling techniques described under "Electrostatically Sensitive (ES) Devices" in the *Servicing Precautions* section of basic service data.

STAR or SHADING (* ■) See PRODUCT SAFETY NOTICE on page 2 of this Service Data.

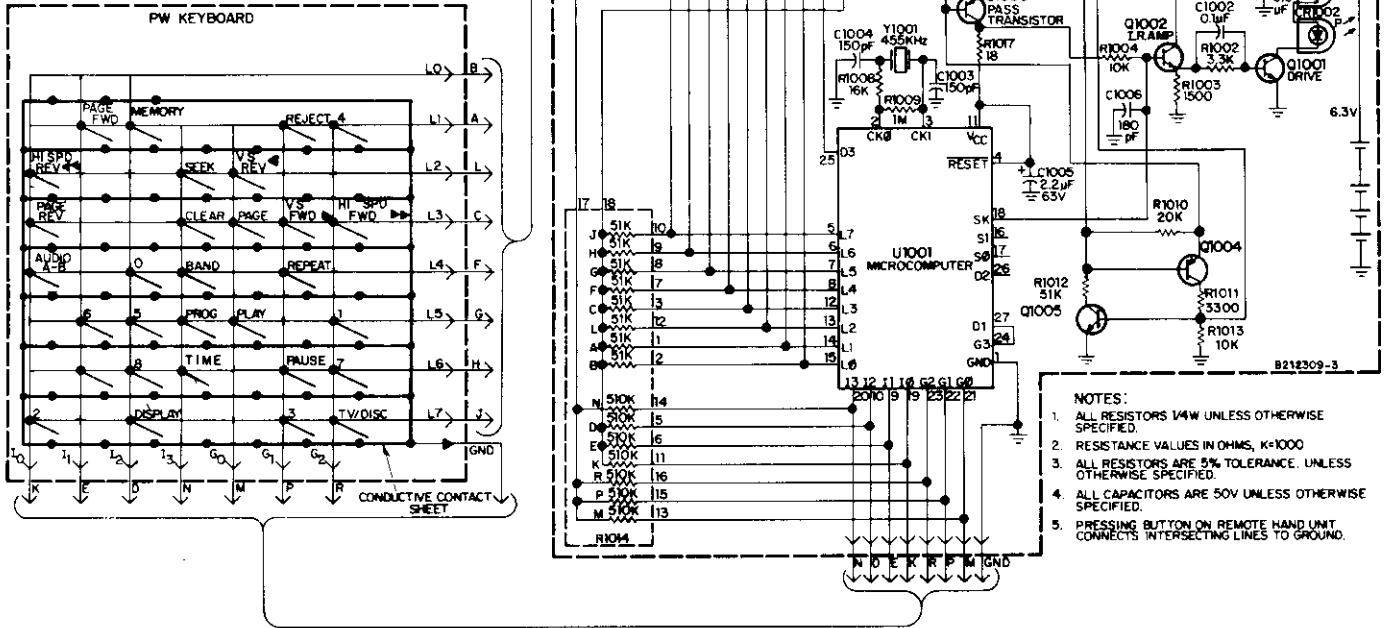
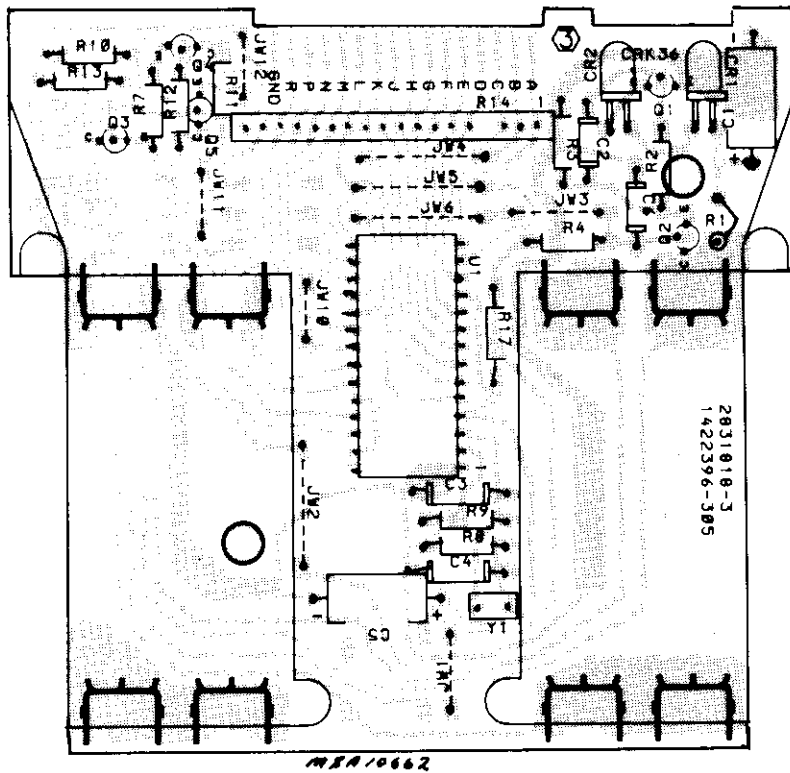

Fig. 50—CRK36 IR Remote Transmitter Schematic



NOTE: Add 1000 Series Prefix to Item Numbers

Fig. 51—PW 1000 Circuit Board

STAR or SHADING (*)
See PRODUCT SAFETY NOTICE
on page 2 of this Service Data.

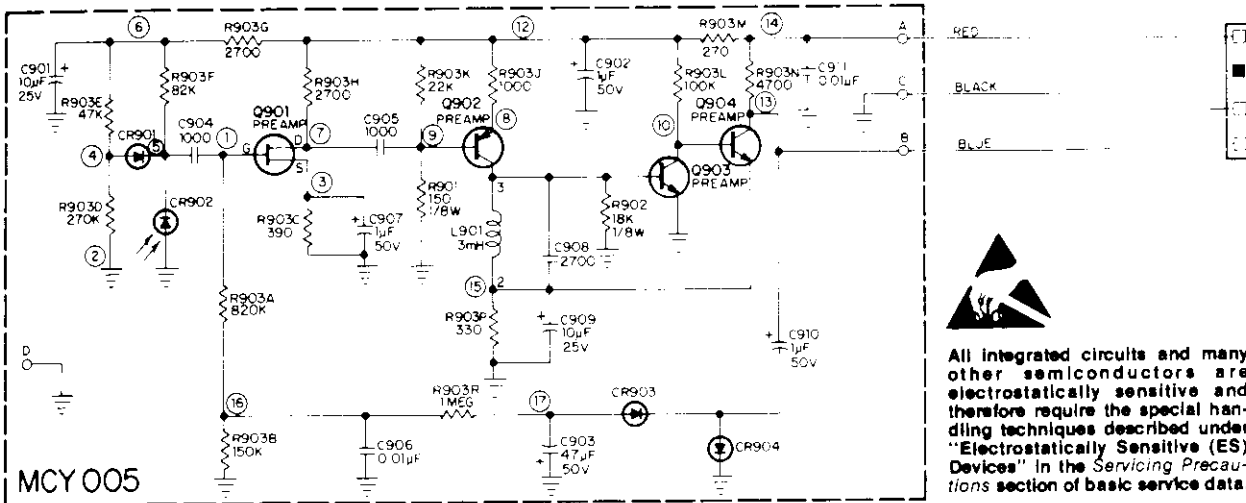
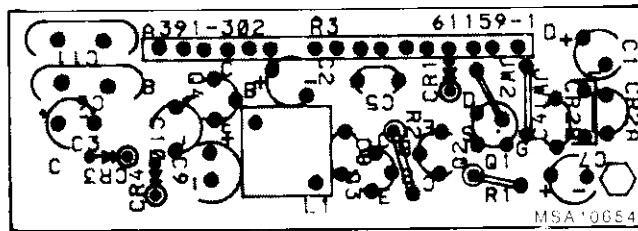

Fig. 52—MCY005C Preamp Schematic



NOTE: Add 900 Series Prefix to Item Numbers

Fig. 53—PW900 Circuit Board Assembly

STYLUS LIFTER ALIGNMENT

If stylus lifter has been removed the use of a Lifter Alignment Gauge (see replacement parts list for Stock No.) is required when replacing it in the arm assembly.

The replacement and alignment procedure is as follows:

1. Reinstall Lifter Actuator Assembly - do not replace Lifter Pivot Clips at this time, see illustration.
2. Install Lifter Alignment Gauge (in same manner as installing Stylus Cartridge), see illustration.
3. Replace Lifter Pivot Clips (one on each side of arm assembly) and check to assure stylus lifter operates freely, see illustration.
4. Remove Lifter Alignment Gauge and install Stylus Cartridge.

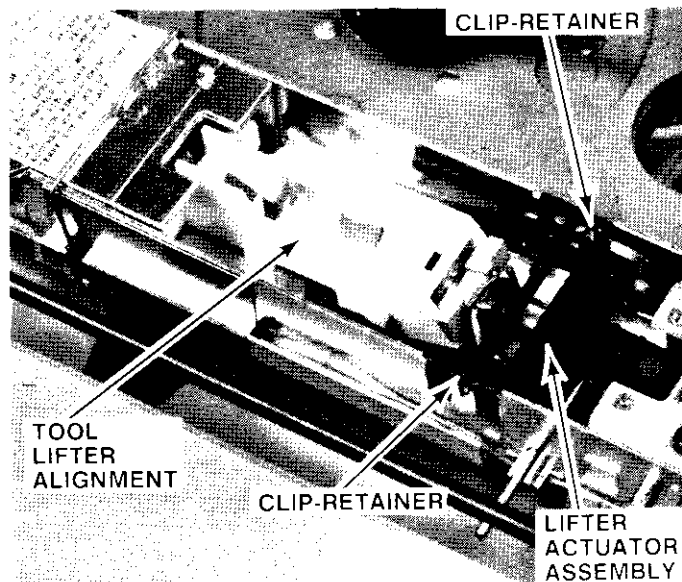

Stylus Lifter Alignment

REPLACEMENT PARTS

BEFORE REPLACING PARTS, READ THE FOLLOWING:

RCA-Approved Substitute Stock Numbers—Before ordering stock numbers in this parts list, look for an RCA-approved substitute stock number in the current *RCA Distributor & Special Products Price Schedule*. This will minimize your service time and avoid ordering parts you already have in stock.

See your RCA Distributor for Replacement Parts and Accessories.

Warranty Status of Assemblies and Parts The warranty status of some assemblies and parts are indicated by one of the following Warranty Status Codes:

- Complete assembly not eligible for warranty exchange or replacement
- Eligible for warranty exchange for new or rebuilt unit
- Complete assembly eligible for warranty replacement with new or rebuilt unit

All parts listed without a Warranty Status Code symbol are eligible for warranty replacement as discrete components.

Warranty replacement of cabinet parts requires prior approval of RCA.

Warranty Status and Specifications of assemblies and parts are subject to change without notice.

PRODUCT SAFETY NOTE—Components marked with a (★) have special characteristics important to safety. Before replacing any of these components, read carefully the **PRODUCT SAFETY NOTICE** in the Basic Service Data. Do not degrade the safety of the set through improper servicing. Although assemblies as a whole may not be marked with a (★), replacement of RCA assemblies with other assemblies not RCA approved may result in a safety hazard.

Canada Stock Numbers:
Add prefix 62 to all stock numbers.

..... AVOID REPLACEMENT PART ERRORS

File supplements and addendums immediately upon receipt, and consult the parts lists in them before ordering parts.

NOTE: This complete coverage of all parts and assemblies used in this product is available with the chassis series to which this service data relates. Consult the following publications:

- **Basic Service Data**—Chassis and tuning systems and most related parts and assemblies that do not differ from one model or model group to another
 - **Service Data Supplements**—Cabinet, auxiliary, and other parts and assemblies that differ from one model group to another
 - **Service Data Addendum**—Any parts additions, deletions, or other changes made after initial production
- Do not replace or order parts without first consulting any Addendum(s) that may have been issued since publication of this service data.

SYMBOL NO.	STOCK NO.	DRAWING NO.	DESCRIPTION	SYMBOL NO.	STOCK NO.	DRAWING NO.	DESCRIPTION
SJT400							
ELECTRICAL ASSEMBLIES & COMPONENTS							
	157928	2812587-501	• CIRCUIT, AC INPUT PW600	C2513	149189	993286-153	CAP POLY .15UF J 100V
	157926	2816408-502	• CIRCUIT, ARM INTERCONNECT	C2514	147971	2841255-31M	CAPCD .01UF M Z5P 50V
	158005	2816404-501	• CIRCUIT, DISPLAY	C2515	147971	2841255-31M	CAPCD .01UF M Z5P 50V
	159570	2816406-501	• CIRCUIT, FEATURES PW6100	C2516	148407	2841250-67A	CAPCD 33PF D NPO 50V
	157924	2812585-501	• CIRCUIT, PICKUP PREAMP PW400	C2517	147971	2841255-31M	CAPCD .01UF M Z5P 50V
	155878	2812595-502	± CIRCUIT, RESONATOR	C2701	143866	2841251-83A	CAPCD 27PF J NPO 50V
				C2702	143866	2841251-83A	CAPCD 27PF J NPO 50V
				C2703	143866	2841251-83A	CAPCD 27PF J NPO 50V
				C2705	143752	2840363-531	CAP LYTC 470UF R 16V
				C3102	153576	2841253-53H	CAPCD 470PF J N750 50V
				C3103	135452	2841253-13H	CAPCD 220PF J N750 50V
				C3104	149164	2872860-113	CAP POLY .01UF K 50V
				C3105	134939	2841255-50R	CAPCD .047UF Z Z5V 50V
				C3106	143874	2841252-83H	CAPCD 150PF J N750 50V
				C3107	134939	2841255-50R	CAPCD .047UF Z Z5V 50V
				C3108	134939	2841255-50R	CAPCD .047UF Z Z5V 50V
				C3109	134939	2841255-50R	CAPCD .047UF Z Z5V 50V
				C3110	134939	2841255-50R	CAPCD .047UF Z Z5V 50V
				C3111	146210	2841273-553	CAP LYTC 4.7UF M 85C 50V
				C3112	147971	2841255-31M	CAPCD .01UF M Z5P 50V
				C3117	146256	2841274-143	CAP LYTC 100UF M 25V
				C3118	146256	2841274-143	CAP LYTC 100UF M 25V
				C3119	143871	2841252-63H	CAPCD 100PF J N750 50V
				C3120	145434	2841252-53H	CAPCD 82PF J N750 50V
				C3121	146833	2841251-93H	CAPCD 33PF J N750 50V
				C3122	146256	2841274-143	CAP LYTC 100UF M 25V
				C3123	134939	2841255-50R	CAPCD .047UF Z Z5V 50V
				C3124	134939	2841255-50R	CAPCD .047UF Z Z5V 50V
				C3125	146256	2841274-143	CAP LYTC 100UF M 25V
				C3201	143871	2841252-63H	CAPCD 100PF J N750 50V
				C3202	146833	2841251-93H	CAPCD 33PF J N750 50V
				C3203	143874	2841252-83H	CAPCD 150PF J N750 50V
				C3204	149203	2841275-143	CAP LYTC 100UF M 85C 25V
				C3205	134939	2841255-50R	CAPCD .047UF Z Z5V 50V
				C3206	143867	2841252-23A	CAPCD 47PF J NPO 50V
				C3207	146768	2841251-53A	CAPCD 15PF J NPO 50V
				C3208	135452	2841253-13H	CAPCD 220PF J N750 50V
				C3209	146249	2841251-63A	CAPCD 18PF J NPO 50V
				C3210	134939	2841255-50R	CAPCD .047UF Z Z5V 50V
				C3211	143879	2841253-91M	CAPCD 1000PF M Z5P 50V
				C3212	146249	2841251-63A	CAPCD 18PF J NPO 50V
				C3213	146249	2841251-63A	CAPCD 18PF J NPO 50V
				C3214	146833	2841251-93H	CAPCD 33PF J N750 50V
				C3215	149196	2871417-001	CAP TRIM 40PF 250V
				C3216	145434	2841252-53H	CAPCD 82PF J N750 50V
				C3217	134939	2841255-50R	CAPCD .047UF Z Z5V 50V
				C3218	149151	2841252-13A	CAPCD 39PF J NPO 50V
				C3219	149204	2841274-442	CAP LYTC 33UF N 85C 25V
				C3221	157206	2841287-563	CAP LYTC 22UF M 50V
				C3222	143871	2841252-63H	CAPCD 100PF J N750 50V
				C3223	103245	2841251-43A	CAPCD 12PF J NPO 50V
				C3224	146768	2841251-53A	CAPCD 15PF J NPO 50V
				C3225	143871	2841252-63H	CAPCD 100PF J N750 50V
				C3226	157205	2841250-82A	CAPCD 4.7PF K NPO 50V
				C3227	143867	2841252-23A	CAPCD 47PF J NPO 50V
				C3228	143879	2841253-91M	CAPCD 1000PF M Z5P 50V
				C3229	157204	2841250-92A	CAPCD 5.6PF K NPO 50V
				C3301	154336	2871335-083	CAP POLY 47UF K 100V
				C3302	143967	2841254-81M	CAPCD 4700PF M Z5P 50V

Replacement Parts Continued (See Product Safety Note on first page of this parts list)

SYMBOL NO.	STOCK NO.	DRAWING NO.	DESCRIPTION	SYMBOL NO.	STOCK NO.	DRAWING NO.	DESCRIPTION
C3303	148057	2840393-92M	CAPCT 1000PF K Z5P 50V	C4001	149203	2841275-143	CAP LYTC 100UF M 85C 25V
C3304	149161	2841274-243	CAP LYTC 15UF M 85C 25V	C4002	134939	2841255-50R	CAPCD .047UF Z Z5V 50V
C3307	134939	2841255-50R	CAPCD .047UF Z Z5V 50V	C4003	149203	2841275-143	CAP LYTC 100UF M 85C 25V
C3308	153925	2872860-125	CAP POLY 0.1UF K 50V	C4004	134939	2841255-50R	CAPCD .047UF Z Z5V 50V
C3309	146418	2841252-93A	CAPCD 180PF J NPO 50V	C4107	134939	2841255-50R	CAPCD .047UF Z Z5V 50V
C3310	112969	1490939-703	CAPCD .1UF Z Y5T 50V	C4108	134939	2841255-50R	CAPCD .047UF Z Z5V 50V
C3311	143874	2841252-83H	CAPCD 150PF J N750 50V	C4109	134939	2841255-50R	CAPCD .047UF Z Z5V 50V
C3312	135452	2841253-13H	CAPCD 220PF J N750 50V	C4110	134939	2841255-50R	CAPCD .047UF Z Z5V 50V
C3313	146210	2841273-553	CAP LYTC 4.7UF M 85C 50V	C4111	149188	2871335-129	CAP POLY .015UF J 100V
C3314	134939	2841255-50R	CAPCD .047UF Z Z5V 50V	C4112	149163	2872860-217	CAP POLY .022UF J 50V
C3315	143874	2841252-83H	CAPCD 150PF J N750 50V	C4113	149188	2872860-215	CAP POLY .015UF J 50V
C3316	147036	2840395-30N	CAPCT .010UF M Z5R 50V	C4114	149163	2872860-217	CAP POLY .022UF J 50V
C3317	146210	2841273-553	CAP LYTC 4.7UF M 85C 50V	C4117	146536	2841273-362	CAP LYTC 2.2UF N 85C 50V
C3318	147635	2841262-005	CAPCD 130PF J NPO 50V	C4118	146536	2841273-362	CAPCD .01UF M Z5P 50V
C3319	135452	2841253-13H	CAPCD 220PF J N750 50V	C4119	147971	2841255-31M	CAPCD .01UF M Z5P 50V
C3320	157211	2872860-205	CAP POLY .0022UF J 50V	C4121	147971	2841255-31M	CAPCD 470PF J N750 50V
C3321	146210	2841273-553	CAP LYTC 4.7UF M 85C 50V	C4122	153576	2841253-53H	CAPCD 390PF M N750 50V
C3322	148057	2840393-92M	CAPCT 1000PF K Z5P 50V	C4125	143967	2841254-81M	CAPCD 4700PF M Z5P 50V
C3323	146418	2841252-93A	CAPCD 180PF J NPO 50V	C4126	143967	2841254-81M	CAPCD .047UF Z Z5V 50V
C3324	149147	2841262-006	CAPCD 300PF J N750 50V	C4127	134939	2841255-50R	CAPCD .047UF Z Z5V 50V
C3325	146418	2841252-93A	CAPCD 180PF J NPO 50V	C4128	134939	2841255-50R	CAP LYTC 10UF M 25V
C3326	143874	2841252-83H	CAPCD 150PF J N750 50V	C4129	146256	2841274-143	CAP LYTC 10UF M 25V
C3327	149203	2841275-143	CAP LYTC 100UF M 85C 25V	C4201	146256	2841274-143	CAPCD 47PF J NPO 50V
C3328	134939	2841255-50R	CAPCD .047UF Z Z5V 50V	C4202	143867	2841252-23A	CAPCD 47PF J NPO 50V
C3329	146256	2841274-143	CAP LYTC 10UF M 25V	C4203	143867	2841252-23A	CAPCD 47PF J NPO 50V
C3330	134939	2841255-50R	CAPCD .047UF Z Z5V 50V	C4204	153925	2872860-125	CAP POLY 0.1UF K 50V
C3331	134939	2841255-50R	CAPCD .047UF Z Z5V 50V	C4205	139444	2871335-075	CAP POLY .1UF K 100V
C3333	134939	2841255-50R	CAPCD .047UF Z Z5V 50V	C4206	143967	2841254-81M	CAPCD 4700PF M Z5P 50V
C3335	146418	2841252-93A	CAPCD 180PF J NPO 50V	C4207	143967	2841254-81M	CAP LYTC 1UF M 85C 50V
C3336	134939	2841255-50R	CAPCD .047UF Z Z5V 50V	C4207	141868	2841273-163	CAPCD .1UF Z Y5T 50V
C3401	135452	2841253-13H	CAPCD 220PF J N750 50V	C4301	112969	1490939-703	CAP LYTC 10UF M 25V
C3402	145741	2841254-41N	CAPCD 2200PF M Z5T 50V	C4302	146256	2841274-143	CAP LYTC .33UF K 50V
C3403	149163	2872860-017	CAP POLY .022UF M 50V	C4401	154354	2841288-164	CAP LYTC .33UF K 50V
C3404	145434	2841252-53H	CAPCD 82PF J N750 50V	C4402	154354	2841288-164	CAP LYTC 10UF M 25V
C3405	157215	2840394-22N	CAPCT 1500PF K Z5R 50V	C4403	146256	2841274-143	CAP LYTC 10UF M 25V
C3406	142329	1490301-141	CAP LYTC 10UF R 25V	C4404	146256	2841274-143	CAP LYTC 10UF M 25V
C3407	147036	2840395-30N	CAPCT .010UF M Z5R 50V	C4501	146256	2841274-143	CAP LYTC 10UF M 25V
C3408	146254	2841262-004	CAPCD 91PF J NPO 50V	C4502	154354	2841288-164	CAP LYTC .33UF K 50V
C3409	157204	2841250-92A	CAPCD 5.6PF NPO K 50V	C4601	146256	2841274-143	CAP LYTC 10UF M 25V
C3410	142329	1490301-141	CAP LYTC 10UF R 25V	C4602	146256	2841274-143	CAP LYTC 10UF M 25V
C3411	134939	2841255-50R	CAPCD .047UF Z Z5V 50V	C4603	143882	2841254-21M	CAPCD 1500PF M Z5P 50V
C3412	157203	2841262-016	CAPCD 36PF J NPO 50V	C4604	143882	2841254-21M	CAPCD 1500PF M Z5P 50V
C3413	149146	2841262-008	CAPCD 200PF J NPO 50V	C4605	146256	2841274-143	CAP LYTC 10UF M 25V
C3414	145676	2841252-43A	CAPCD 68PF J NPO 50V	C4606	146256	2841274-143	CAP LYTC 10UF M 25V
C3415	157203	2841262-016	CAPCD 36PF J NPO 50V	C4607	145741	2841254-41N	CAPCD 2200PF M Z5T 50V
C3416	143879	2841253-91M	CAPCD 1000PF M Z5P 50V	C4608	145741	2841254-41N	CAPCD 2200PF M Z5T 50V
C3417	157210	2872860-101	CAP POLY .001UF K 50V	C5101	141868	2841273-163	CAP LYTC 1UF M 85C 50V
C3418	134939	2841255-50R	CAPCD .047UF Z Z5V 50V	C5102	134939	2841255-50R	CAPCD .047UF Z Z5V 50V
C3419	147971	2841255-31M	CAPCD .01UF M Z5P 50V	C5103	157199	2841251-73A	CAPCD 22PF J NPO 50V
C3420	143879	2841253-91M	CAPCD 1000PF M Z5P 50V	C5104	134939	2841255-50R	CAPCD .047UF Z Z5V 50V
C3421	134939	2841255-50R	CAPCD .047UF Z Z5V 50V	C5105	146256	2841274-143	CAP LYTC 10UF M 25V
C3422	143866	2841251-83A	CAPCD 27PF J NPO 50V	C5106	149204	2841274-442	CAP POLY .067UF M 50V
C3423	135452	2841253-13H	CAPCD 220PF J N750 50V	C5107	157207	2872860-023	CAP LYTC 1UF M 85C 50V
C3424	157216	2871335-161	CAP POLY .33UF J 100V	C5108	141868	2841273-163	CAP LYTC 100UF M 85C 25V
C3425	148057	2840393-92M	CAPCT 1000PF K Z5P 50V	C5109	149203	2841275-143	CAP LYTC 100UF M 85C 25V
C3426	149188	2871335-129	CAP POLY .015UF J 100V	C5111	147971	2841255-31M	CAPCD .01UF M Z5P 50V
C3427	157209	2871335-157	CAP POLY .22UF J 100V	C5112	147971	2841255-31M	CAPCD .01UF M Z5P 50V
C3428	157208	2871335-151	CAP POLY .12UF J 100V	C5113	147971	2841255-31M	CAPCD .01UF M Z5P 50V
C3431	147036	2840395-30N	CAPCT .010UF M Z5R 50V	C5114	147971	2841255-31M	CAPCD .01UF M Z5P 50V
C3432	142329	1490301-141	CAP LYTC 10UF R 25V	C5115	147971	2841255-31M	CAPCD .01UF M Z5P 50V
C3433	134939	2841255-50R	CAPCD .047UF Z Z5V 50V	C5116	147971	2841255-31M	CAPCD .01UF M Z5P 50V
C3434	134939	2841255-50R	CAPCD .047UF Z Z5V 50V	C5117	147971	2841255-31M	CAPCD .01UF M Z5P 50V
C3435	148523	2840392-83J	CAPCT 150PF J NPO 50V	C5119	147971	2841255-31M	CAPCD .01UF M Z5P 50V
C3436	147971	2841255-31M	CAPCD .01UF M Z5P 50V	C5120	147971	2841255-31M	CAPCD .01UF M Z5P 50V
C3437	147971	2841255-31M	CAPCD .01UF M Z5P 50V	C5121	147971	2841255-31M	CAPCD .01UF M Z5P 50V
C3501	143879	2841253-91M	CAPCD 1000PF M Z5P 50V	C5122	147971	2841255-31M	CAPCD .01UF M Z5P 50V
C3502	143879	2841253-91M	CAPCD 1000PF M Z5P 50V	C5123	147971	2841255-31M	CAPCD .01UF M Z5P 50V
C3503	143885	2841262-010	CAPCD 110PF J NPO 50V	C5124	147971	2841255-31M	CAPCD .01UF M Z5P 50V
C3504	146254	2841262-004	CAPCD 91PF J NPO 50V	C5125	147971	2841255-31M	CAPCD .01UF M Z5P 50V
C3505	147036	2840395-30N	CAPCT .010UF M Z5R 50V	C5126	147971	2841255-31M	CAPCD .01UF M Z5P 50V
C3510	143866	2841251-83A	CAPCD 27PF J NPO 50V	C5127	143879	2841253-91M	CAPCD 1000PF M Z5P 50V
C3511	143867	2841252-23A	CAPCD 47PF J NPO 50V	C5128	134939	2841255-50R	CAPCD .047UF Z Z5V 50V
C3512	157200	2841262-019	CAPCD 62PF J NPO 50V	C5129	143879	2841253-91M	CAPCD 1000PF M Z5P 50V
C3513	146833	2841251-93H	CAPCD 33PF J N750 50V	C5130	143879	2841253-91M	CAPCD 1000PF M Z5P 50V
C3514	143879	2841253-91M	CAPCD 1000PF M Z5P 50V	C5301	159640	2872860-225	CAP POLY 0.1UF J 50V
C3515	143879	2841253-91M	CAPCD 1000PF M Z5P 50V	C5302	134939	2841255-50R	CAPCD .047UF Z Z5V 50V
C3516	147971	2841255-31M	CAPCD .01UF M Z5P 50V	C5303	143879	2841253-91M	CAPCD 1000PF M Z5P 50V
C3517	145741	2841254-41N	CAPCD 2200PF M Z5T 50V	C5304	149204	2841274-442	CAP LYTC 33UF N 25V
C3518	147971	2841255-31M	CAPCD .01UF M Z5P 50V	C5901	134939	2841255-50R	CAPCD .047UF Z Z5V 50V
C3519	143871	2841252-63D	CAPCD 100PF J N150 50V	C5902	132174	1474578-007	CAP TRIM 11PF NPO 500V
C3520	157199	2841251-73A	CAPCD 22PF J NPO 50V	C5903	146768	2841251-53A	CAPCD 15PF J NPO 50V
C3521	145741	2841254-41N	CAPCD 2200PF M Z5T 50V	C5904	145676	2841252-43A	CAPCD 68PF J NPO 50V
C3522	147971	2841255-31M	CAPCD .01UF M Z5P 50V	C5905	146768	2841251-53A	CAPCD 15PF J NPO 50V
C3523	143879	2841253-91M	CAPCD 1000PF M Z5P 50V	C5906	134939	2841255-50R	CAPCD .047UF Z Z5V 50V
C3524	143879	2841253-91M	CAPCD 1000PF M Z5P 50V	C5907	143879	2841253-91M	CAPCD 1000PF M Z5P 50V
C3525	143866	2841251-83A	CAPCD 27PF J NPO 50V	C5908	147036	2840395-30N	CAPCT .010UF M Z5R 50V
C3526	153575	2841253-93J	CAPCD 1000PF J SL 50V	C5909	147036	2840395-30N	CAPCT .010UF M Z5R 50V
C3527	143879	2841253-91M	CAPCD 1000PF M Z5P 50V	C5910	147036	2840395-30N	CAPCT .010UF M Z5R 50V
C3528	143879	2841253-91M	CAPCD 1000PF M Z5P 50V	C5911	146256	2841274-143	CAP LYTC 10UF M 25V
C3530	143879	2841253-91M	CAPCD 1000PF M Z5P 50V				
C3532	143879	2841253-91M	CAPCD 1000PF M Z5P 50V				

Continued on next page

1983 SJT 400 REPLACEMENT PARTS

Replacement Parts Continued (See Product Safety Note on first page of this parts list)

SYMBOL NO.	STOCK NO.	DRAWING NO.	DESCRIPTION	SYMBOL NO.	STOCK NO.	DRAWING NO.	DESCRIPTION
C5912	147971	2841255-31M	CAPCD .01UF M Z5P 50V	CR4204	119597	1471872-006	DIODE
C5913	147971	2841255-31M	CAPCD .01UF M Z5P 50V	CR4205	119597	1471872-006	DIODE
C5914	147971	2841255-31M	CAPCD .01UF M Z5P 50V	CR4401	119597	1471872-006	DIODE
C5915	134939	2841255-50R	CAPCD .047UF Z Z5V 50V	CR4402	119597	1471872-006	DIODE
C5916	134939	2841255-50R	CAPCD .047UF Z Z5V 50V	CR4403	119597	1471872-006	DIODE
C5917	147971	2841255-31M	CAPCD .01UF M Z5P 50V	CR4404	119597	1471872-006	DIODE
C5918	147971	2841255-31M	CAPCD .01UF M Z5P 50V	CR4405	119597	1471872-006	DIODE
C5919	147971	2841255-31M	CAPCD .01UF M Z5P 50V	CR4406	119597	1471872-006	DIODE
C5920	149204	2841274-442	CAP LYTC 33UF N 85C 25V	CR4407	119597	1471872-006	DIODE
C5921	157196	2841255-41L	CAPCD .022UF M Y5R 50V	CR4408	119597	1471872-006	DIODE
C5922	134939	2841255-50R	CAPCD .047UF Z Z5V 50V	CR4501	119597	1471872-006	DIODE
C5931	157196	2841255-41L	CAPCD .022UF M Y5R 50V	CR4502	119597	1471872-006	DIODE
C5941	157196	2841255-41L	CAPCD .022UF M Y5R 50V	CR4503	119597	1471872-006	DIODE
C5951	157196	2841255-41L	CAPCD .022UF M Y5R 50V	CR4504	119597	1471872-006	DIODE
C6105	143882	2841255-30M	CAPCD .01UF Z Z5P 50V	CR4505	119597	1471872-006	DIODE
C6106	143882	2841255-30M	CAPCD .01UF Z Z5P 50V	CR4506	119597	1471872-006	DIODE
C6107	143882	2841255-30M	CAPCD .01UF Z Z5P 50V	CR4507	119597	1471872-006	DIODE
C6108	143882	2841255-30M	CAPCD .01UF Z Z5P 50V	CR5101	119597	1471872-010	DIODE
C6112	134939	2841255-50R	CAPCD .047UF Z Z5V 50V	CR5102	119597	1471872-010	DIODE
C6114	134939	2841255-50R	CAPCD .047UF Z Z5V 50V	CR5103	119597	1471872-010	DIODE
C6115	157216	2871335-161	CAP POLY .33UF J 100V	CR5104	119597	1471872-010	DIODE
C6118	143882	2841255-30M	CAPCD .01UF Z Z5P 50V	CR5106	119597	1471872-006	DIODE
C6128	134939	2841255-50R	CAPCD .047UF Z Z5V 50V	CR5107	119597	1471872-006	DIODE
C6130	134939	2841255-50R	CAPCD .047UF Z Z5V 50V	CR5108	119597	1471872-006	DIODE
C6131	145742	2841254-12M	CAPCD 1200PF K Z5P 50V	CR5110	119597	1471872-010	DIODE
C6132	146833	2841251-93A	CAPCD 33PF J NPO 50V	CR5111	119597	1471872-006	DIODE
C6133	153575	2841253-93J	CAPCD 1000PF J SL 50V	CR5112	119597	1471872-006	DIODE
C6134	154336	2871335-165	CAP POLY .47UF J 100V	CR5114	119597	1471872-010	DIODE
C6135	146256	2841274-143	CAP LYTC 10UF M 25V	CR5115	119597	1471872-006	DIODE
C6136	143871	2841252-63A	CAPCD 100PF J NPO 50V	CR5116	119597	1471872-010	DIODE
C6137	143871	2841252-63A	CAPCD 100PF J NPO 50V	CR5117	119597	1471872-010	DIODE
C6138	147957	2841253-12M	CAPCD 220PF K Z5P 50V	CR5301	119597	1471872-006	DIODE
C6139	143869	2841252-52J	CAPCD 82PF K SL 50V	CR5302	119597	1471872-006	DIODE
C6140	153276	2841251-43J	CAPCD 12PF J SL 50V	CR5901	119597	1471872-006	DIODE
C6141	134939	2841255-50R	CAPCD .047UF Z Z5V 50V	CR5902	119597	1471872-006	DIODE
C6142	146256	2841274-143	CAP LYTC 10UF M 25V	CR5903	119597	1471872-006	DIODE
C6143	159574	2841274-332	CAP LYTC 22UF M 16V	CR5904	119597	1471872-006	DIODE
C6146	134939	2841255-50R	CAPCD .047UF Z Z5V 50V	CR5905	119597	1471872-006	DIODE
C6148	146256	2841274-143	CAP LYTC 10UF M 25V	CR5906	119597	1471872-006	DIODE
C6149	153575	2841253-93J	CAPCD 1000PF J SL 50V	CR5907	119597	1471872-006	DIODE
C6150	134939	2841255-50R	CAPCD .047UF Z Z5V 50V	CR5921	147015	99203-003	DIODE
C6151	143869	2841252-53J	CAPCD 82PF J SL 50V	CR5922	119597	1471872-006	DIODE
C6152	153994	2841254-92M	CAPCD 5600PF K Z5P 50V	CR5923	119597	1471872-010	DIODE
C6153	141868	2841273-163	CAP LYTC 1UF M 85C 50V	CR5931	147015	99203-003	DIODE
C6154	146833	2841251-93H	CAPCD 33PF J N750 50V	CR5932	119597	1471872-006	DIODE
C6155	143874	2841252-82M	CAPCD 150PF K Z5V 50V	CR5933	119597	1471872-010	DIODE
C6158	141868	2841273-163	CAP LYTC 1UF M 85C 50V	CR5941	147015	99203-003	DIODE
C6159	134939	2841255-50R	CAPCD .047UF Z Z5V 50V	CR5942	119597	1471872-006	DIODE
C6160	143882	2841255-32M	CAPCD .01UF K Z5P 50V	CR5943	119597	1471872-010	DIODE
C6161	146764	2841253-31M	CAPCD 330PF M Z5P 50V	CR5951	147015	99203-003	DIODE
C6163	146256	2841274-143	CAP LYTC 10UF M 25V	CR5952	119597	1471872-006	DIODE
C6164	143871	2841252-63A	CAPCD 100PF J NPO 50V	CR5953	119597	1471872-010	DIODE
C6165	134939	2841255-50R	CAPCD .047UF Z Z5V 50V	CR6110	119597	1471872-010	DIODE
C6166	143882	2841255-32M	CAPCD .01UF K Z5P 50V	CR6111	119597	1471872-010	DIODE
				CR6112	119597	1471872-010	DIODE
				CR6113	119597	1471872-010	DIODE
CR101	119597	1471872-006	DIODE	CR6115	119597	1471872-010	DIODE
CR601	147015	99203-206	DIODE	CR6116	119597	1471872-010	DIODE
CR602	147015	99203-206	DIODE	CR6121	119597	1471872-010	DIODE
CR603	147015	99203-206	DIODE	CR6122	119597	1471872-010	DIODE
CR604	147015	99203-206	DIODE	CR6123	119597	1471872-010	DIODE
CR605	147015	99203-206	DIODE	CR6124	119597	1471872-010	DIODE
CR606	147015	99203-206	DIODE	CR6125	157629	2816291-001	DIODE
CR607	147015	99203-206	DIODE	CR6126	119597	1471872-010	DIODE
CR608	147015	99203-206	DIODE	CR6127	119597	1471872-010	DIODE
CR609	119597	1471872-006	DIODE	CR6128	119597	1471872-010	DIODE
CR610	119597	1471872-006	DIODE	CR6130	119597	1471872-010	DIODE
CR611	119597	1471872-006	DIODE	CR6131	119597	1471872-010	DIODE
CR1701	157637	1466679-013	DIODE LED SIDE 1	CR6132	119597	1471872-010	DIODE
CR1702	157637	1466679-013	DIODE LED SIDE 2	CR6134	119597	1471872-010	DIODE
CR1703	157637	1466679-013	DIODE LED AUD A	CR6135	119597	1471872-010	DIODE
CR1704	157637	1466679-013	DIODE LED AUD B	CR6136	119597	1471872-006	DIODE
CR1705	157637	1466679-013	DIODE LED STEREO	CR6137	119597	1471872-006	DIODE
CR2009	119597	1471872-010	DIODE	CR6138	157629	2816291-001	DIODE
CR2501	159264	2873415-001	DIODE	CR6140	119597	1471872-010	DIODE
CR3101	159264	2873415-001	DIODE	CR6141	119597	1471872-010	DIODE
CR3102	119597	1471872-010	DIODE	CR6143	119597	1471872-010	DIODE
CR3401	119597	1471872-010	DIODE	CR6144	119597	1471872-010	DIODE
CR3402	119597	1471872-010	DIODE	CR6145	119597	1471872-010	DIODE
CR3403	119597	1471872-010	DIODE	CR6147	119597	1471872-010	DIODE
CR3501	149033	1477074-002	DIODE				
CR3502	129095	1477022-002	DIODE	DS1701	149020	2840935-001	LED DISPLAY
CR3503	129095	1477022-002	DIODE				
CR3504	129095	1477022-002	DIODE				
CR3505	129095	1477022-002	DIODE				
CR3506	129095	1477022-002	DIODE	E3201	153328	2843165-004	BEAD
CR4001	119597	1471872-006	DIODE	E3301	153328	2843165-004	BEAD
CR4002	119597	1471872-006	DIODE	E3302	153328	2843165-004	BEAD
CR4102	119597	1471872-006	DIODE	E3303	153328	2843165-004	BEAD
CR4201	119597	1471872-006	DIODE	E3501	153328	2843165-004	BEAD
CR4202	119597	1471872-006	DIODE	E3502	153328	2843165-004	BEAD
CR4203	119597	1471872-006	DIODE	E3503	153328	2843165-004	BEAD
				E3504	153328	2843165-004	BEAD

Continued on next page

Replacement Parts Continued (See Product Safety Note on first page of this parts list)

SYMBOL NO.	STOCK NO.	DRAWING NO.	DESCRIPTION	SYMBOL NO.	STOCK NO.	DRAWING NO.	DESCRIPTION
F601	156261	2840454-506	* FUSE 0.6A	Q2002	145776	1417303-003	TRANSISTOR CURRENT LIMITER
HE1	157638	2816248-001	TRANSISTOR HALL EFFECT	Q2003	146847	1417306-013	TRANSISTOR DRIVER
HE2	157638	2816248-001	TRANSISTOR HALL EFFECT	Q2004	145395	1417318-007	TRANSISTOR REGULATOR
J4	149208	1466404-001	CONNECTOR	Q2005	140979	1417364-001	TRANSISTOR REGULATOR
J6	149208	1466404-001	CONNECTOR	Q2006	146847	1417306-013	TRANSISTOR CURRENT LIMITER
J11	158021	2861623-004	CONNECTOR	Q2007	146847	1417306-013	TRANSISTOR CURRENT LIMITER
J101	158697	2873321-001	CONNECTOR 8 PIN	Q2501	146847	1417306-013	TRANSISTOR RF AMP
J2701	157182	2816401-504	JACK VIDEO W/BRACKET	Q2502	146847	1417306-013	TRANSISTOR OUTPUT DET SW
J4601	157181	2816401-503	JACK AUDIO W/BRACKET	Q2503	146847	1417306-013	TRANSISTOR OUTPUT DET SW
J4602	157189	2816401-503	JACK AUDIO W/BRACKET	Q2504	150247	1417411-003	TRANSISTOR GAIN CONTROL
J6101	159575	2873400-104	CONNECTOR 4 PIN	Q2505	145776	1417303-003	TRANSISTOR AGC AMP
J6102	149208	1466404-001	CONNECTOR	Q2506	145776	1417303-003	TRANSISTOR SYNC STRIPPER
J6106	149208	1466404-001	CONNECTOR	Q2507	146847	1417306-013	TRANSISTOR CLAMP
J6107	149208	1466404-001	CONNECTOR	Q2701	146847	1417306-013	TRANSISTOR VIDEO DRIVER
J6109	159576	2873386-008	CONNECTOR 8 PIN	Q3101	146847	1417306-013	TRANSISTOR N-LAC BUFFER
L101	158695	2861409-001	COIL	Q3102	149040	1417387-001	TRANSISTOR N-LAC AMP
L102	157938	2812595-506	COIL ARM STRETCHER	Q3103	146847	1417306-013	TRANSISTOR N-LAC AMP
L103	157936	2831713-001	COIL SKIPPER	Q3104	146847	1417306-013	TRANSISTOR N-LAC OUT DRIVER
L104	157934	2861415-001	COIL SWEEPER	Q3105	146847	1417306-013	TRANSISTOR 716KHZ AMP
L601	157929	2873085-001	* COIL LINE CHOKE	Q3107	146847	1417306-013	TRANSISTOR CONTROL AMP
L2701	153921	2841228-219	COIL 33UH	Q3201	146847	1417306-013	TRANSISTOR PHASE CORRECTION
L3105	149171	2841228-234	COIL 560UH	Q3202	146847	1417306-013	TRANSISTOR VIDEO BUFFER
L3201	149173	2841228-221	COIL 47UH	Q3301	146847	1417306-013	TRANSISTOR DELAY VIDEO DRIVE
L3202	154050	2841228-220	COIL 39UH	Q3303	146847	1417306-013	TRANSISTOR VERT DETAIL
L3203	149170	2841228-112	COIL 8.2UH	Q3304	146847	1417306-013	TRANSISTOR CHROMA DRIVER
L3204	149171	2841228-234	COIL 560UH	Q3305	145776	1417303-003	TRANSISTOR CHROMA BUFFER
L3205	149173	2841228-221	COIL 47UH	Q3306	146847	1417306-013	TRANSISTOR LUMA BUFFER
L3206	149176	2841228-217	COIL 22UH	Q3401	146847	1417306-013	TRANSISTOR VIDEO BUFFER
L3207	149173	2841228-221	COIL 47UH	Q3402	146847	1417306-013	TRANSISTOR VIDEO AMP
L3208	149175	2841228-214	COIL 12UH	Q3403	146847	1417306-013	TRANSISTOR CLK PHASE SHIFTER
L3301	149167	2841228-223	COIL 68UH	Q3404	146847	1417306-013	TRANSISTOR CLOCK BUFFER
L3302	149167	2841228-223	COIL 68UH	Q3405	146847	1417306-013	TRANSISTOR XDCR DRIVER
L3303	149176	2841228-217	COIL 22UH	Q3406	149041	1417351-002	TRANSISTOR XDCR DRIVER
L3304	149168	2841228-224	COIL 82UH	Q3407	146847	1417306-013	TRANSISTOR XDCR DRIVER
L3305	149176	2841228-217	COIL 22UH	Q3408	149041	1417351-002	TRANSISTOR XDCR DRIVER
L3306	149176	2841228-217	COIL 22UH	Q3409	146847	1417306-013	TRANSISTOR VIDEO BLANKER
L3401	149177	2841271-001	COIL 36UH	Q3412	151326	1417360-001	TRANSISTOR NOISE CORING AMP
L3402	157189	1467370-005	COIL 62UH	Q3413	146847	1417306-013	TRANSISTOR NOISE CORING AMP
L3403	157190	1467370-006	COIL 20UH	Q3501	149040	1417387-001	TRANSISTOR BIAS SWITCH
L3404	149176	2841228-217	COIL 22UH	Q4102	146847	1417306-013	TRANSISTOR DECODER DEFEAT
L3405	149175	2841228-214	COIL 12UH	Q4301	146847	1417306-013	TRANSISTOR LEFT CH BUFFER
L3501	157191	2873326-002	COIL .069UH	Q4302	146847	1417306-013	TRANSISTOR RIGHT CH BUFFER
L3502	157191	2873326-002	COIL .069UH	Q4501	149040	1417387-001	TRANSISTOR CURRENT SOURCE
L3505	157194	2872884-002	COIL 0.22UH	Q5101	145776	1417303-003	TRANSISTOR LS DIGIT DRIVER
L3506	157193	2873326-016	COIL .235UH	Q5102	145776	1417303-003	TRANSISTOR MS DIGIT DRIVER
L3507	157193	2873326-016	COIL .235UH	Q5103	146847	1417306-013	TRANSISTOR DAXI STATUS
L3508	157194	2872884-002	COIL 0.22UH	Q5104	145395	1417318-007	TRANSISTOR STEPPER OUTPUT
L3509	157188	1467370-001	COIL 10UH	Q5105	146847	1417306-013	TRANSISTOR STEPPER DRIVER
L3511	157195	1496280-003	COIL .33UH	Q5106	149041	1417351-002	TRANSISTOR STEPPER OUTPUT A
L4107	153920	2843031-001	COIL 18MH	Q5107	145395	1417318-007	TRANSISTOR STEPPER OUTPUT B
L4108	153920	2843031-001	COIL 18MH	Q5108	146847	1417306-013	TRANSISTOR LIFTER DRIVE
L5101	157187	2872884-017	COIL 5.6UH	Q5109	149041	1417351-002	TRANSISTOR LIFTER OUTPUT
L5901	157187	2872884-017	COIL 5.6UH	Q5110	146847	1417306-013	TRANSISTOR VERT DETAIL DRIVE
L6101	159579	2871333-007	COIL OSD 1MHZ ADJ	Q5111	146847	1417306-013	TRANSISTOR STEPPER DRIVE C
L6102	149195	1467370-003	COIL OSD 6MHZ ADJ	Q5112	149041	1417351-002	TRANSISTOR STEPPER OUTPUT C
L6103	159577	2873601-146	COIL 270UH	Q5113	145776	1417303-003	TRANSISTOR LED DISPLAY
L6104	159578	2873601-150	COIL 390UH	Q5114	145776	1417303-003	TRANSISTOR DISCRETE LED
P1	158674	2861623-109	CONNECTOR 9 PIN	Q5115	146847	1417306-013	TRANSISTOR LOW VOLTAGE DET
P2	158675	2861084-204	CONNECTOR 4 PIN	Q5116	146847	1417306-013	TRANSISTOR RESET SWITCH
P3	158020	2861623-011	CONNECTOR 11 PIN	Q5301	146847	1417306-013	TRANSISTOR REV RAMP SWITCH
P4	158673	2861084-102	CONNECTOR 2 PIN	Q5302	146847	1417306-013	TRANSISTOR FWD RAMP SWITCH
P5	158676	2861084-105	CONNECTOR 5 PIN	Q5303	146847	1417306-013	TRANSISTOR KICK PULSE DRIVER
P6	158673	2861084-102	CONNECTOR 2 PIN	Q5304	145776	1417303-003	TRANSISTOR KICK PULSE DRIVER
P7	149182	1477678-104	CONNECTOR 5 PIN	Q5305	159299	1417327-004	TRANSISTOR KICK PULSE
P8	149182	1477678-104	CONNECTOR 2 PIN	Q5306	159300	1417328-003	TRANSISTOR KICK PULSE
P9	158673	2861084-102	CONNECTOR 2 PIN	Q5901	159299	1417327-004	TRANSISTOR KICK PULSE
P11	158021	2861623-004	CONNECTOR 4 PIN	Q5902	146847	1417306-013	TRANSISTOR REV FUNCTION SW
P12	149180	1477678-001	CONNECTOR 2 PIN	Q5903	159299	1417327-004	TRANSISTOR FUNC DR REV
P101	157525	1467740-071	CONNECTOR 8 PIN	Q5904	146847	1417306-013	TRANSISTOR FWD FUNCTION SW
P1101	157524	2861623-107	CONNECTOR 7 PIN	Q5905	145395	1417318-007	TRANSISTOR FUNC DR FWD
P5601	157525	1467740-071	CONNECTOR 8 PIN	Q5906	145395	1417318-007	TRANSISTOR FUNC MTR OUTPUT
P6102	149180	1477678-001	CONNECTOR 2 PIN	Q5907	145776	1417303-003	TRANSISTOR FUNC MTR OUTPUT
P6103	159639	2861623-008	CONNECTOR 8 PIN	Q5908	146847	1417306-013	TRANSISTOR PAUSE LINE BUFFER
P6104	149182	1477678-104	CONNECTOR 5 PIN	Q5909	146847	1417306-013	TRANSISTOR SW DRIVER REV
P6105	158019	2861623-010	CONNECTOR 10 PIN	Q5921	159300	1417328-003	TRANSISTOR SW DRIVER FWD
P6106	149180	1477678-001	CONNECTOR 2 PIN	Q5922	146847	1417306-013	TRANSISTOR CURRENT SOURCE
P6107	149180	1477678-001	CONNECTOR 2 PIN	Q5923	159299	1417327-004	TRANSISTOR CURRENT SOURCE
P6109	157525	1467740-071	CONNECTOR 8 PIN	Q5931	159300	1417328-003	TRANSISTOR CURRENT SOURCE
Q101	145395	1417318-007	TRANSISTOR SWEEP	Q5932	146847	1417306-013	TRANSISTOR DRIVE AMP
Q102	146847	1417306-013	TRANSISTOR INVERTER	Q5923	159299	1417327-004	TRANSISTOR TURNTABLE MOTOR
Q401	151326	1417360-001	TRANSISTOR GAIN STAGE	Q5931	159300	1417328-003	TRANSISTOR DRIVE AMP
Q402	151326	1417360-001	TRANSISTOR OUTPUT DRIVER	Q5932	146847	1417306-013	TRANSISTOR DRIVE AMP
Q403	143794	1417306-012	TRANSISTOR AFT AMP				
Q404	143794	1417306-012	TRANSISTOR AFT REF AMP				
Q405	156262	1417382-002	TRANSISTOR SEARCH OSC				
Q2001	155882	1417422-001	TRANSISTOR REGULATOR				

Continued on next page

1983 SJT 400 REPLACEMENT PARTS

Replacement Parts Continued (See Product Safety Note on first page of this parts list)

SYMBOL NO.	STOCK NO.	DRAWING NO.	DESCRIPTION	SYMBOL NO.	STOCK NO.	DRAWING NO.	DESCRIPTION
Q5933	159299	1417327-004	TRANSISTOR TURNTABLE MOTOR DRIVER A	R3443	829322	993218-729	RES CF 1/4W 2% 22K
Q5941	159300	1417328-003	TRANSISTOR CURRENT SOURCE SWITCH	R3446	829022	993113-185	* RES MFFP1/4W 5% 22R
Q5942	146847	1417306-013	TRANSISTOR DRIVE AMP	R3449	829033	993113-189	* RES MFFP 1/4W 5% 33R
Q5943	159299	1417327-004	TRANSISTOR TURNTABLE MOTOR DRIVER B	R3452	157340	2815583-469	RES CF 1/8W 5% 1M
Q5951	159300	1417328-003	TRANSISTOR CURRENT SOURCE SW	R3464	829110	993113-201	* RES MFFP 1/4W 5% 100R
Q5952	146847	1417306-013	TRANSISTOR DRIVE AMP	R3509	829068	993113-197	* RES MFFP 1/4W 5% 68R
Q5953	159299	1417327-004	TRANSISTOR TURNTABLE MOTOR DRIVER C	R3510	829068	993113-197	* RES MFFP 1/4W 5% 68R
Q6101	157631	1417383-001	TRANSISTOR ANT BUFFER SW	R3511	829310	993218-721	RES CF 1/4W 2% 10K
Q6102	146847	1417306-013	TRANSISTOR CAV BUS RCVR	R3515	829247	993218-713	RES CF 1/4W 2% 4700R
Q6103	146847	1417306-013	TRANSISTOR LOW VOLT DET	R3524	829130	993218-684	RES CF 1/4W 2% 300R
Q6104	146847	1417306-013	TRANSISTOR RESET SW	R3529	829239	993218-711	RES CF 1/4W 2% 3.9K
Q6105	146847	1417306-013	TRANSISTOR CAV BUFFER	R3531	829115	993218-677	RES CF 1/4W 2% 150R
Q6106	157632	1417386-001	TRANSISTOR PHASE DET DW	R3532	829010	993218-349	RES CF 1/4W 5% 10R
Q6107	149040	1417387-001	TRANSISTOR PHASE DET UP	R4111	151270	1479265-047	RES CONTROL 716KHZ VCO FREQ ADJ
Q6108	157632	1417386-001	TRANSISTOR PLAYER VIDEO SW	R4112	151270	1479265-047	RES CONTROL 905KHZ VCO FREQ ADJ
Q6109	157632	1417386-001	TRANSISTOR CHAR VIDEO SW	R4127	151371	1479265-049	RES CONTROL L + R LEVEL ADJ
Q6110	149040	1417387-001	TRANSISTOR CHAR VIDEO AMP	R4128	151371	1479265-049	RES CONTROL
Q6111	146847	1417306-013	TRANSISTOR CAV BUS DRVR	R4140	829010	993113-177	* RES MFFP 1/4W 5% 10R
Q6114	140076	1417309-001	TRANSISTOR IR BUFFER AMP	R4141	829010	993113-177	* RES MFFP 1/4W 5% 10R
Q6115	146847	1417306-013	TRANSISTOR SYNC TIP BIAS AMP	R4203	829522	993218-477	RES CF 1/4W 5% 2.2M
Q6116	149040	1417387-001	TRANSISTOR BIAS TRACKING	R4204	829522	993218-477	RES CF 1/4W 5% 2.2M
Q6117	146847	1417306-013	TRANSISTOR RKM BUFFER	R4205	829522	993218-477	RES CF 1/4W 5% 2.2M
R1	156333	2872667-003	RES CONTROL RADIUS SENSE	R4206	829522	993218-477	RES CF 1/4W 5% 2.2M
R401	153030	993113-203	* RES MFFP1/4W 5% 120R	R4209	829239	993218-711	RES CF 1/4W 2% 3.9K
R411	829311	993218-722	RES CF 1/4W 2% 11K	R4210	829175	993218-694	RES CF 1/4W 2% 750R
R412	829222	993218-705	RES CF 1/4W 2% 2200R	R4213	157333	2815583-728	RES CF 1/8W 2% 20K
R414	829010	993218-349	RES CF 1/4W 5% 10R	R4214	829322	993218-729	RES CF 1/4W 2% 22K
R417	829022	993113-185	* RES MFFP 1/4W 5% 22R	R4303	151371	1479265-049	RES CONTROL
R601	502547	82283-106	RES CC 1/2W 10% 4.7M	R4305	829320	993218-728	RES CF 1/4W 2% 20K
R2002	830B56	993291-319	* RES MF 1/2W 5% .56R	R4306	157333	2815583-728	RES CF 1/8W 2% 20K
R2003	830B56	993291-319	* RES MF 1/2W 5% .56R	R4308	157333	2815583-728	RES CF 1/8W 2% 20K
R2005	829156	993113-219	* RES MFFP 1/4W 5% 560R	R4310	829522	993218-477	RES CF 1/4W 5% 2.2M
R2006	157214	990401-416	RES MF 1/4W 1% 14.3K	R4311	829320	993218-728	RES CF 1/4W 2% 20K
R2007	157213	990401-401	RES MF 1/4W 1% 10K	R4312	157333	2815583-728	RES CF 1/8W 2% 20K
R2008	157212	990401-430	RES MF 1/4W 1% 20K	R4317	157333	2815583-728	RES CF 1/8W 2% 20K
R2009	157213	990401-401	RES MF 1/4W 1% 10K	R4503	157333	2815583-728	RES CF 1/8W 2% 20K
R2010	829068	993113-197	* RES MFFP 1/4W 5% 68R	R4504	157338	2815583-708	RES CF 3K 2% 1/8W
R2013	830A68	993273-345	* RES CFFP 1/2W 5% 6.8R	R4505	157332	2815583-752	RES CF 1/8W 2% 200K
R2014	830033	993290-189	* RES MFFP 1/2W 5% 33R	R4506	157333	2815583-728	RES CF 1/8W 2% 20K
R2016	157336	2815583-721	RES CF 1/8W 2% 10K	R4507	157377	2815583-711	RES CF 1/8W 2% 3.9K
R2017	157334	2815583-724	RES CF 1/8W 2% 13K	R4508	829210	993218-697	RES CF 1/4W 2% 1K
R2019	829522	993218-477	RES CF 1/4W 5% 2.2M	R4509	157376	2815583-737	RES CF 1/8W 2% 47K
R2020	143848	1479265-013	RES CONTROL 5V REF	R4510	829147	993218-689	RES CF 1/4W 2% 470R
R2024	830A10	2817720-325	* RES CFFP 1/8W 5% 1R	R4615	829147	993218-689	RES CF 1/4W 2% 470R
R2025	829A27	993272-335	* RES CFFP 1/4W 5% 2.7R	R4616	829147	993218-689	RES CF 1/4W 2% 470R
R2504	829010	993113-177	* RES MFFP 1/4W 5% 10R	R5126	829239	993218-711	RES CF 1/4W 2% 3.9K
R2516	157335	2815583-722	RES CF 1/8W 2% 11K	R5127	829047	993113-193	* RES MFFP 1/4W 5% 47R
R2704	829115	993113-205	* RES MFFP1/4W 5% 150R	R5138	829010	993117-177	* RES MFFP 1/4W 5% 10R
R3101	829130	993218-684	RES CF 1/4W 2% 300R	R5139	829010	993113-177	* RES MFFP 1/4W 5% 10R
R3118	829010	993113-177	* RES MFFP 1/4W 5% 10R	R5156	829010	993218-349	* RES CF 1/4W 5% 10R
R3129	829110	993113-201	* RES MFFP 1/4W 5% 100R	R5157	829010	993218-349	RES CF 1/4W 5% 10R
R3131	151270	1479265-047	RES CONTROL DC BAL ADJ	R5303	159641	2815583-731	RES CF 1/8W 2% 27K
R3202	147615	1479265-020	RES CONTROL VIDEO LEVEL ADJ	R5304	159642	2815583-739	RES CF 1/8W 2% 56K
R3213	829010	993113-177	* RES MFFP 1/4W 5% 10R	R5305	159643	2815583-725	RES CF 1/8W 2% 15K
R3221	157333	2815583-728	RES CF 1/8W 2% 20K	R5308	159644	2815583-745	RES CF 1/8W 2% 100K
R3222	157333	2815583-728	RES CF 1/8W 2% 20K	R5309	829010	993113-177	* RES MFFP 1/4W 5% 10R
R3304	151270	1479265-047	RES CONTROL DELAY VIDEO ADJ	R5315	147040	993218-472	RES CF 1/4W 5% 1.3M
R3312	146175	1479265-019	RES CONTROL CHROMA LEVEL ADJ	R5917	830022	993290-185	* RES MFFP 1/2W 5% 22R
R3315	829133	993218-685	RES CF 1/4W 2% 330R	R5923	829110	993113-201	* RES MFFP 1/4W 5% 100R
R3316	829133	993218-685	RES CF 1/4W 2% 330R	R5926	830A10	2817720-325	* RES CFFP 1/8W 5% 1R
R3317	146175	1479265-019	RES CONTROL VERT DETAIL LEVEL ADJ	R5933	829110	993113-201	* RES MFFP 1/4W 5% 100R
R3322	829133	993218-685	RES CF 1/4W 2% 330R	R5936	830A10	2817720-325	* RES CFFP 1/2W 5% 1R
R3323	829133	993218-685	RES CF 1/4W 2% 330R	R5943	829110	993113-201	* RES MFFP 1/4W 5% 100R
R3324	829133	993218-685	RES CF 1/4W 2% 330R	R5946	830A10	2817720-325	* RES CFFP 1/2W 5% 1R
R3325	830113	993290-204	* RES MFFP1/2W 5% 130R	R5923	829110	993113-201	* RES MFFP 1G4W 5% 100R
R3326	829239	993218-711	RES CF 1/4W 2% 3.9K	R5956	145384	993273-325	* RES CFFP 1/2W 5% 1.0R
R3327	829239	993218-711	RES CF 1/4W 2% 3.9K	R6169	151267	1479265-046	RES CONTROL SYNC TIP ADJ
R3328	143849	1479265-009	RES CONTROL LUMA CHANNEL ADJ	S1	156527	2831429-004	* SWITCH POWER
R3329	143849	1479265-009	RES CONTROL CHROMA CHANNEL ADJ	S2	157639	1495451-026	* SWITCH AC OFF
R3402	146175	1479265-019	RES CONTROL MOD DEPTH ADJ	S3	156527	2831429-004	* SWITCH POWER
R3404	157995	2815583-707	RES CF 1/8W 2% 2700R	S4	157519	2860855-001	SWITCH CADDY SENSE
R3407	157339	2815583-704	RES CF 1/8W 2% 2K	S5	157519	2860855-001	SWITCH SPINE SENSE
R3408	157994	2815583-715	RES CF 1/8W 2% 5.6K	S6	157519	2860855-001	SWITCH SIDE ID
R3412	146175	1479265-019	RES CONTROL VC XD GAIN ADJ	S7	157519	2860855-001	SWITCH MECHANISM PLAY
R3418	147960	993272-341	* RES CFFP1/4W 5% 4.7R	S8	157519	2860855-001	SWITCH CADDY REVERSE
R3419	143848	1479265-013	RES CONTROL PHASE DET GAIN ADJ	S9	157518	2860855-004	SWITCH MECHANISM LOAD
R3424	157340	2815583-469	RES CF 1/8W 5% 1M	S10	157519	2860855-001	SWITCH LANDING
R3438	147040	993218-472	RES CF 1/4W 5% 1.3M	S11	157519	2860855-001	SWITCH ARM HOME
R3441	147040	993218-472	RES CF 1/4W 5% 1.3M	S3501	158002	2816401-502	SWITCH CHANNEL SELECT
R3442	147040	993218-472	RES CF 1/4W 5% 1.3M	S5601			
				THRU			
				S5607	157861	2861083-001	SWITCH FUNCTION MEMBRANE
				T1	156300	2816285-001	* TRANSFORMER POWER
				U2001	149018	1421754-001	IC REF AMP/BUFFER/ERROR AMP
				U2501	149019	1465648-001	IC SYNC DETECTOR

Continued on next page

Replacement Parts Continued (See Product Safety Note on first page of this parts list)

SYMBOL NO.	STOCK NO.	DRAWING NO.	DESCRIPTION	SYMBOL NO.	STOCK NO.	DRAWING NO.	DESCRIPTION
U3101	149019	1465648-001	IC SYNC DETECTOR	33	157581	2861038-001	ROD, FRT REC ACTIVATING
U3201	149036	1421760-001	IC VIDEO FM DEMODULATOR	34	157570	2844037-003	SPRING, EXT PAWL CAM
U3301	149039	1421752-001	IC COMB FILTER/DEFECT CORRECTOR	35	157583	2861095-001	ACTUATOR, RECEIVER CAM
U3401	149018	1421754-001	IC ARM STRETCHER DRIVE/ ERROR AMP	36	157946	2873027-002	CAM
U3402	149034	1421761-001	IC VIDEO CONVERTER	37	157945	2873043-002	ROD
U3501	149037	1421758-001	IC RF MODULATOR	38	157543	2873024-001	COUPLING, TRANSFER ROD
U4101	149035	1421760-002	IC AUDIO DEMODULATOR L+R	39	157563	2816453-504	GEAR, FUNCTION ASSEMBLY
U4102	149035	1421760-002	IC AUDIO DEMODULATOR L-R	40	157577	2861029-002	GEAR, PAWL DRIVE
U4200	154027	1421710-002	IC TRACK/HOLD MUTE	41	157568	2844015-001	NUT, PUSH
U4300	149018	1421754-001	IC AUDIO MATRIX & BUFFER	42	157588	2873026-001	ACTUATOR, ARM REAR REC
U4400	153405	1421754-002	IC DECODER RECTIFIER	43	157836	2816453-507	RAIL
U4500	149018	1421754-001	IC DECODER CONTROL	44	157571	2844055-001	SHIELD, SWITCH
U4600	153406	1421769-001	IC DECODER AMPLIFIER	45	157599	2861400-001	SCREW
U5101	155883	1421786-001	IC PLAYER CONTROL MICROCOMPUTER	46	157574	2861013-001	ARM, LOCKOUT CADDY RIGHT
U5102	149016	1421751-001	IC DAXI BUFFER	47	157538	2861085-002	ACTUATOR, MECHANISM OFF
U5901	155886	1421787-001	IC MECHANISM MICROCOMPUTER	48	157548	2873324-001	SPRING, OFF ACTUATOR
U5902	149018	1421754-001	IC TURNTABLE DRIVE	49	157572	2844057-001	INSERT, FRONT REC PAD
U6101	157633	1421805-001	IC FEATURES	50	157587	2873021-003	CRANK, DOOR STOP
U6102	157634	1421802-001	IC RKM	51	157562	2831466-002	PAD, REC FRONT
U6103	157635	1421783-001	IC OSD	52	157569	2844031-001	SPACER, SPINE HOLDDOWN
U6104	149017	1421753-003	IC 5V REGULATOR	53	157582	2861057-001	ROD, HOLD DOWN SPINE
U6105	157636	1421734-002	IC D FLIP-FLOP	54	158000	2843632-001	SPRING
VR2001	156030	1471898-015	DIODE ZENER 5.8V	55	157871	2873392-001	STOP, CADDY MISALIGNMENT
VR3301	149042	99202-315	DIODE ZENER 9.1V	56	157591	2873348-001	BLOCK, LIFTER LOCK
VR5101	141829	1471898-006	DIODE ZENER 2.85V	57	157529	2843660-001	SPRING, TORSION READ PAD
VR6101	141829	1471898-006	DIODE	58	157542	2873016-001	SPRING, SPINE LATCH
VR6102	157630	1497049-004	DIODE	59	157610	2873016-002	SPRING, SPINE LATCH
W6101	159636	2873391-002	CABLE 10 CONDUCTOR	60	157537	2861005-139	LATCH, ASSEMBLY
W6102	159637	2873391-001	CABLE 5 CONDUCTOR	61	157531	2843697-003	CLIP, SPACER
Y3401	157186	2872120-005	CRYSTAL 5.11MHZ	62	157523	2831467-001	PAD, REAR RECEIVER
Y5901	157185	2872120-006	CRYSTAL 3.58MHZ	63	157541	2873013-001	GEAR, LOWER POWER ASSIST
153933	1466338-528	* CORD, POWER		64	157528	2843656-002	SPRING, SPINE PUSHBACK
157992	2861060-002	COVER, BOTTOM RF MOD		65	157604	2816456-503	ROD, TRANSFER ASSEMBLY
157990	2872684-001	COVER, BOTTOM COMB FILTER		66	157549	2873334-001	SHIELD, AC BOARD
157991	2861416-001	COVER, TOP RF MOD		67	157854	2831487-002	PLATE, SWITCH MTG
157534	2844019-001	GROMMET, STRAIN RELIEF POWER CORD		68	153026	93605-106	RETAINER
143813	1442970-007	INSULATOR, FOR Q2005		69	157602	2861068-002	SPINDLE, TURNTABLE
149231	2840997-001	KEY, POLARIZING		70	157999	2873092-002	SPRING
158001	2861422-001	SHIELD, MICROPROCESSOR		71	157603	2873091-002	SPRING, DISC GROUND
158003	2816401-505	SHIELD, COMB FILTER		72	155880	2816455-501	TURNTABLE
154403	1447129-002	SPACER, TRANSISTOR MTG		73	157864	2861400-013	SCREW
139506	1449797-001	TERMINAL, FOR P7,P8,P12,P6102, P6104, P6106,P6107		74	157556	2873369-002	SPACER
158022	2873023-101	TERMINAL, SOLDERLESS		75	158670	2840736-004	GROMMET
157527	2843655-001			76	157853	2873042-002	BRACKET, SWITCH
149084	990303-086			77	157605	2816456-502	ARM, SWEEPER ASSEMBLY
157532	2844001-002			78	157606	2816456-506	ARM, LOCK 1 PAIR
157550	2873335-003			79	157544	2873047-002	SHAFT, ARM CARRIAGE
157996	2861400-012			80	157927	2861434-002	SHIELD, ESD
157554	2873356-001			81	157551	2873347-001	SUPPORT, CENTER MASTER BOARD
157547	2873323-001			82	157527	2843655-001	SPRING, TRANSFER ROD
157539	2861408-001			83	149084	990303-086	NUT
157540	2861424-002			84	157532	2844001-002	PLATE, FILLER
157997	2843605-001			85	157550	2873335-003	BRACKET, DISPLAY HOLDDOWN
157533	2844007-001			86	157996	2861400-012	SCREW
157870	2844022-002			87	157554	2873356-001	COVER, SWITCH
157526	2831703-001			88	157547	2873323-001	SPACER, SWITCH
157558	2873377-001			89	157539	2861408-001	SHIELD, POWER SWITCH
157552	2873349-002			90	157540	2861424-002	CAP, POWER SWITCH
157536	2844048-001			91	157997	2843605-001	SCREW
157546	2873302-002			92	157533	2844007-001	SPRING, SWEEPER EXTENSION
157530	2843689-002			93	157870	2844022-002	CLIP, GROUNDING
157559	2873389-001			94	157526	2831703-001	COVER, BOTTOM
159571	2861433-001			95	157558	2873377-001	BUSHING, BASE PAN
157849	2843683-001			96	157552	2873349-002	FOOT, PAD
157598	2873065-003			97	157536	2844048-001	PLATE, REINFORCING
157597	2873011-001			98	157546	2873302-002	NUT, ADJUSTING
157601	2843624-001			99	157530	2843689-002	SCREW, HEIGHT ADJUSTMENT
157596	2873064-001			100	157559	2873389-001	WASHER, GUARD ADJ NUT
157600	2861047-001			101	159571	2861433-001	PANEL
157609	2861050-002			102	157849	2843683-001	PLATE, THRUST
157937	2812595-507			103	157598	2873065-003	GEAR, 3RD REDUCTION
157998	93600-115			104	157597	2873011-001	GEAR, 2ND REDUCTION
157648	2812593-502			105	157601	2843624-001	GEAR
157876	2873068-001			106	157596	2873064-001	GEAR, 1ST REDUCTION
157883	2873337-002			107	157600	2861047-001	LEVER
157875	2812595-505			108	157609	2861050-002	BRACKET
157877	2873083-001			109	157937	2812595-507	PLUNGER
157886	2812595-504			110	157998	93600-115	SCREW
157882	2873072-001			111	157648	2812593-502	ARM, PICKUP LESS CARTRIDGE
157888	2844023-002			112	157876	2873068-001	LATCH
157874	2873374-001			113	157883	2873337-002	SPRING, LIFTER LOCK
157881	2861049-002			114	157875	2812595-505	COVER, CARTRIDGE
157890	2843659-004			115	157877	2873083-001	CLIP
157889	93605-402			116	157886	2812595-504	LIFTER, ACTUATOR ASSEMBLY
157888	2873072-001			117	157882	2873072-001	SHAFT, LIFTER
157874	2873374-001			118	157888	2844023-002	PLUNGER, LOCK
157881	2861049-002			119	157874	2873374-001	BEARING
157890	2843659-004			120	157881	2861049-002	RACK, STEPPER DRIVER
157889	93605-402			121	157890	2843659-004	SPRING, LOCK
157889	93605-402			122	157889	93605-402	RETAINER, E-RING

MECHANICAL ASSEMBLIES

NOTE: SOME PARTS WITH ITEM NUMBERS ON EXPLODED VIEWS MAY NOT BE AVAILABLE SEPERATELY. OR MAY BE AVAILABLE ONLY AS PART OF AN ASSEMBLY.

1	159573	2831493-004	* CABINET, TOP
2	158241	2816230-119	SCREW
3	157868	2873332-003	ROD, DOOR PUSH
4	157862	2861423-002	COVER, CABLE
5	157566	2873364-001	SPRING, POWER BUTTON
6	157863	2873405-001	NUT, PUSH
7	159645	2861019-003	BUTTON, POWER SWITCH
8	159572	2831482-003	* CABINET, FRONT
9	157580	2861032-002	PIVOT, DISC (LEFT)
10	157858	2816456-508	DOOR, CADDY
11	159646	2831471-003	BUTTONS, 7 FUNCTION
12	159580	2816419-504	PANEL, FRONT ASSEMBLY
13	157579	2861032-001	PIVOT, DISC (RIGHT)
14	157578	2844064-001	CLIP, GROUND
15	157522	2831443-001	SPINDLE, RECEIVER
16	157565	2843699-001	WIRE, CAMSIDE REC
17	157590	2873329-002	COVER, GEAR
18	157592	2873380-002	BELT
19	157584	2861432-001	PULLEY, & GEAR 1ST REDUCTION
20	157560	480366-005	RETAINER, RING
21	157576	2861026-002	GEAR, & PINION
22	157585	2873003-001	GEAR, POWER ASSIST
23	157573	2844062-001	WASHER, SHIM
24	157608	2831483-003	RAIL
25	155094	93610-105	WASHER
28	157564	2843631-001	SPRING, CADDY LOCKOUT
29	157575	2861014-001	ARM, LOCKOUT CADDY LEFT
30	155099	2841782-001	SCREW
31	157545	2873055-004	HUB, ASSEMBLY POWER ASSIST
32	157586	2873004-001	SHAFT, HUB POWER ASSIST

Continued on next page

Replacement Parts Continued (See Product Safety Note on first page of this parts list)

SYMBOL NO.	STOCK NO.	DRAWING NO.	DESCRIPTION	SYMBOL NO.	STOCK NO.	DRAWING NO.	DESCRIPTION
123	157936	2831713-001	COIL, KICKER/SKIPPER	CR1002	148056	2811593-001	DIODE LED
124	157938	2812595-506	COIL, ARM STRETCHER ASSEMBLY	PW1000	159568	2844126-502	CIRCUIT COMPLETE
125	157878	2873088-001	GASKET, GROUNDING	Q1001	148996	1417318-003	TRANSISTOR
126	157879	2844073-001	RETAINER, PUSH-ON	Q1002	146847	1417306-013	TRANSISTOR
127	157887	2861088-001	ACTUATOR, SWEEPER	Q1003	157808	1417347-005	TRANSISTOR
128	157891	2843659-003	SPRING, SWEEPER PLUNGER	Q1004	142190	1417330-001	TRANSISTOR
129	157884	2873312-001	ROLLER	Q1005	146847	1417306-013	TRANSISTOR
130	157885	2812595-503	ARM, SWEEPER	R1014	159569	2861600-001	NETWORK
	157521	1490104-004	RETAINER, WIRE TOP LOCKING	U1001	157806	1421774-001	IC
	157555	2873363-001	RETAINER, WIRE SIDE LOCKING	Y1001	157804	1422271-004	CRYSTAL
REMOTE PREAMP							
MCY005C							
MCY 005C	158664	2844138-503	‡ MODULE COMPLETE		159566	2831396-001	BUTTONS
C901	146365	2840361-551	CAP LYTC 4.7UF R 35V		159563	2831336-002	CASE, BOTTOM
C902	141868	2840361-161	CAP LYTC 1UF R 50V		159564	2831397-002	CASE, TOP
C903	146439	2841288-363	CAP LYTC .47UF M 85C 50V		157801	2870620-002	CONNECTOR, EDGE BOARD
C904	143879	1491407-91M	CAPCD 1000PF M Z5P 50V		157803	2872801-001	CONTACT, BATTERY
C905	143879	1491407-91M	CAPCD 1000PF M Z5P 50V		157791	2860777-001	DOOR, BATTERY
C906	147971	2843235-31M	CAPCD .01UF M Z5P 50V		157793	2841285-002	FOOT
C907	141868	2840361-161	CAP LYTC 1UF R 50V		157799	2831334-002	HOLDER, L BATTERY
C908	145315	1491408-52M	CAPCD 2700PF K Z5P 50V		157800	2831334-001	HOLDER, R BATTERY
C909	146211	2840362-141	CAP LYTC 10UF R 25V		159567	2831507-001	SWITCH, KIT CONTACT AND SPACER
C910	141868	2840361-161	CAP LYTC 1UF R 50V		157789	2860775-001	LENS, IR
C911	147971	2843235-31M	CAPCD .01UF M Z5P 50V		159565	2831398-001	OVERLAY
CR901	119597	1471872-010	DIODE		129796	1444961-001	SPRING, BATTERY CONTACT
CR903	119597	1471872-010	DIODE		157797	2844414-001	SPRING, GROUND
CR904	119597	1471872-010	DIODE	154216	2816412-501		CARTRIDGE, VIDEO PICKUP
CR902A/B	150711	2815416-001	DIODE PHOTO				
L901	157642	1445867-008	COIL				
Q901	148070	1417411-001	TRANSISTOR	149073	2812522-503		● CADDY, LESS DISC
Q902	145410	1417330-011	TRANSISTOR	153394			DISC, STEREO ALIGNMENT
Q903	148061	1417333-002	TRANSISTOR	156529			● GAUGE, TURNTABLE HEIGHT
Q904	148061	1417333-002	TRANSISTOR	149053	2811825-002		LUBRICANT, OIL
R903	157643	2861160-001	NETWORK	149247	2811870-001		LUBRICANT, RYKON
				151303			● TOOL, HEX 2.5MM
	157640	2840591-002	COVER, REAR	159251			● TOOL, LIFTER ALIGNMENT
	133319	938316-013	GROMMET				
REMOTE TRANSMITTER ASSEMBLY							
CRK36A							
	156533	1457638-501	‡ TRANSMITTER, REMOTE				
C1001	157810	2841205-009	CAP LYTC 3.3UF 50V	AH011	2871056-001		ADAPTER, 75 OHM COAX TO 300 OHM TWIN LEAD OUTPUT
C1002	157811	2841245-301	CAPCD .1UF M Z5U 50V	AH018	2871464-001		ADAPTER, 75 TO 300 OHM W/90 DEGREE PUSH-ON COAX CONNECTOR
C1003	148060	2840392-82M	CAPCT 150PF K Z5P 0050V				BATTERIES, 1.5V AA
C1004	148060	2840392-82M	CAPCT 150PF K Z5P 0050V	AH010	2871472-001		BOOK, INSTRUCTION
C1005	157809	1490300-371	CAP LYTC 2.2UF 63V				CABLE, 300 OHM EXTENSION 5 FEET
C1006	145396	2840392-92M	CAPCD 180PF M Z5P 50V	153938	2872677-001		CABLE, STEREO
CR1001	148056	2811593-001	DIODE LED	AH004	2873052-001		CABLE, RF
				156533	2817358-001		CARD, SIMPLIFIED INSTRUCTIONS
					1457638-501		‡ TRANSMITTER, REMOTE CRK36A

STYLUS CARTRIDGE

TOOLS & LUBES

INCLUDED ACCESSORIES