

*Operating
Instructions*

VIDEODISC PLAYER **LaserDisc™**
PR-8210

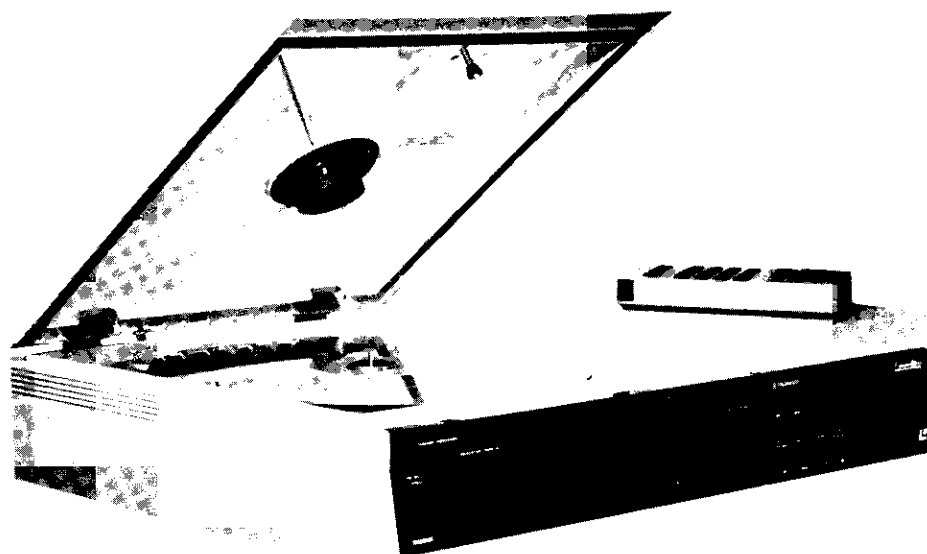

IMPORTANT NOTICE

Caution: Use of controls or adjustments, or performance of procedures other than those specified herein may result in hazardous radiation exposure.

WARNING: TO PREVENT FIRE OR SHOCK HAZARD, DO NOT EXPOSE THIS APPLIANCE TO RAIN OR MOISTURE.

 **PIONEER®**

SAFETY INSTRUCTIONS

READ INSTRUCTIONS — All the safety and operating instructions should be read before operating the appliance.

RETAIN INSTRUCTIONS — The operating instructions should be retained for future reference.

HEED WARNINGS — All warnings on the appliance and in the operating instructions should be adhered to.

FOLLOW INSTRUCTIONS — All operating and related instructions should be followed.

CLEANING — Unplug the appliance from the wall outlet before cleaning. Do not use liquid cleaners or aerosol cleaners. Use a damp cloth for cleaning.

WATER AND MOISTURE

- The appliance should not be used near water — for example, near a bathtub, washbowl, kitchen sink, laundry tub, in a wet basement, or near a swimming pool, etc.
- Do not handle the power cord with wet hands. This is extremely dangerous because you may get an electric shock.
- Moisture forms in the operating sections of the appliance and the appliance's performance will be impaired if the appliance is brought from cool surroundings into a warm room or if the temperature of the room rises suddenly. To prevent this, let the appliance stand in its new surroundings for about an hour before switching it on, or ensure that the room temperature rises gradually.

ACCESSORIES — Do not place the appliance on an unstable cart, stand, tripod, bracket or table. The appliance may fall and possibly cause serious injury, or serious damage to the appliance. Place the appliance on a stable cart, stand, tripod, bracket or table.

VENTILATION — Slots and openings in the cabinet are provided for ventilation, to ensure reliable operation of the appliance and to protect it from overheating. These opening must not be blocked or covered. The openings should never be blocked by placing the appliance on a

bed, sofa, rug or other similar surface. The appliance should not be placed near or over a radiator or heat register. It should not be placed in a built-in installation such as a rack unless proper ventilation is provided or the manufacturer's instructions have been adhered to.

POWER SOURCES — The appliance should be connected to a power supply only of the type described in the operating instructions or as marked on the appliance.

POWER-CORD PROTECTION

- Power-supply cords should be routed so that they are not likely to be walked on or pinched by items placed upon or against them, paying particular attention to cords at plugs, convenience receptacles, and the point where they exit from the appliance.
- Always take hold of the plug to unplug it from the power outlet; do not unplug it by pulling on the cord. The cord may be damaged if you keep pulling on it.

LIGHTNING — For added protection for the appliance during a lightning storm, or when it is left unattended and unused for long periods of time, unplug it from the wall outlet and disconnect the antenna or cable system. This will prevent damage to the appliance due to lightning and power-line surges.

POWER LINES — An outside antenna system should not be located in the vicinity of overhead power lines or circuits as contact with them might be fatal.

OVERLOADING — Do not overload wall outlets and extension cords as this can result in the risk of fire or electric shock.

FOREIGN OBJECTS AND LIQUID — Never push objects of any kind into this appliance through openings as they may contact dangerous voltage areas or other hazards. Be careful not to spill liquid of any kind on the appliance.

OUTDOOR ANTENNA GROUNDING — If an outside antenna is connected to the antenna terminal, be sure the antenna system is grounded so as to provide some protection against voltage surges and built up static charges. Section 810 of the National Electrical Code, ANSI/NEPA No. 70-1978 provides information with respect to proper grounding of the mast and supporting structure, grounding of the lead-in wire to an antenna discharge unit, size of grounding conductors, location of antenna-discharge unit, connection to grounding electrodes and requirements for the grounding electrode. See Fig. A.

EXAMPLE OF ANTENNA GROUNDING AS PER NATIONAL ELECTRICAL CODE INSTRUCTIONS

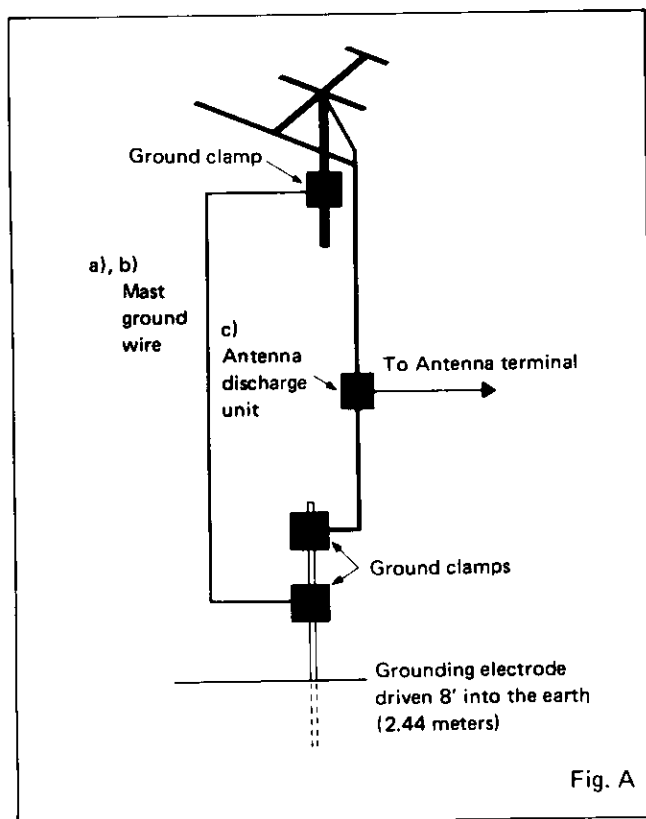

Fig. A

a) Use No. 10 AWG copper wire, No. 8 AWG aluminum wire, No. 17 AWG copper-clad steel wire, bronze wire or larger wire as ground wires for both mast and lead-in.

- b) Secure lead-in wire from antenna to antenna discharge unit and mast ground wire to house with stand-off insulators, spaced from 4 feet (1.22 meters) to 6 feet (1.83 meters) apart.
- c) Mount antenna discharge unit as closely as possible to where lead-in enters house.

NON-USE PERIODS — The power cord of the appliance should be unplugged from the outlet when left unused for a long period of time.

SERVICING — The user should not attempt to service the appliance beyond that described in the operating instructions. Contact your nearest authorized Pioneer service center for all other servicing.

DAMAGE REQUIRING SERVICE — The appliance should be serviced by an authorized Pioneer service center or qualified service personnel when:

- The power-supply cord or the plug has been damaged;
- Objects have fallen onto, or liquid has been spilled into the appliance;
- The appliance has been exposed to rain;
- The appliance does not appear to operate normally or exhibits a marked change in performance; or
- The appliance has been dropped, or the enclosure damaged.

REPLACEMENT PARTS — When replacement parts are required, be sure the service technician has used replacement parts specified by the manufacturer or have the same characteristics as the original part. Unauthorized substitutions may result in fire, electric shock or other hazards.

SAFETY CHECK — Upon completion of any service or repairs to the appliance, ask the service technician to perform safety checks to determine that the appliance is in safe operating condition.

CONTENTS

FEATURES	1	OPERATION WITH THE REMOTE	
BEFORE OPERATION	2	CONTROL UNIT	13
REAR PANEL FACILITIES	3	TROUBLESHOOTING	18
CONNECTIONS	4	SPECIFICATIONS	19
PARTS AND CONTROLS	8	MAINTENANCE	20
OPERATION	10		

FEATURES

No contact pickup system

This system uses a low-powered laser to detect the information recorded on the videodisc. There is no physical contact between the pickup and the videodisc itself, so it is called the "no contact pickup system". This laser, while in operation, projects a continuous beam of light onto the disc on an area measuring no more than one micron in diameter.

Information on the videodisc is stored in the form of microscopic pits which are laid down in a spiral track on a light reflected surface. When the laser beam strikes a series of pits, it is reflected into the system and the variation of the reflected light is converted into the reproduced signal.

Unlike an ordinary phonograph record or other videodisc systems, there is no abrasion and no wear on the disc.

The illustrations to the right show how the laser beam and disc interact in the Pioneer videodisc player.

Both standard play (CAV) and extended play (CLV) videodiscs can be played.

The PR-8210 automatically detects these videodiscs and plays accordingly.

The standard play disc, also known as the CAV or constant angular velocity disc, spins at the same constant speed of 1,800 rpm from the inner circumference to the outer circumference, and provides a maximum of 30 minutes playing time per side.

On the CAV disc, one video picture frame is recorded for each revolution, so a number of additional performance features are possible.

Although the extended play disc, also known as the CLV or constant linear velocity disc, does not offer such additional features, it does have a maximum playing time of one hour per side since the rotational speed continuously varies from 1,800 rpm at the inner circumference to 600 rpm at the outer circumference.

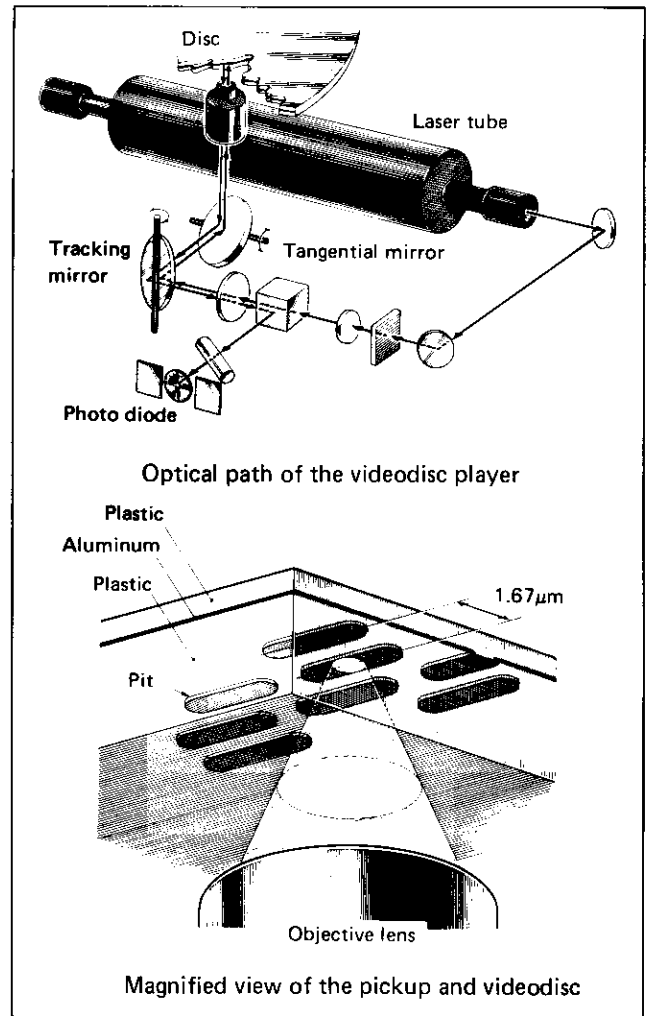

Microcomputer controlled operation to offer many convenient features

A maximum of 54,000 concentric tracks can be contained on one side of a videodisc. For CAV discs, one revolution (one track) contains one frame of information, and each frame is numbered from the innermost to the outer track. This numbering system is used to permit a variety of convenient special functions. For example, each frame (track) can be repeated several times to permit slow motion play, and frames can be skipped to permit triple-speed play. The numbers can also be used to automatically locate a specific frame or chapter of a program (random access).

It's all made possible by the remarkable laser pickup system and a sophisticated microcomputer.

High quality stereo sound

Pioneer videodiscs have two completely discrete audio channels encoded in FM to permit discs to include stereo sound or bilingual commentary.

CX noise reduction system

The PR-8210 can take full advantage of the widened dynamic range and higher S/N ratio of CX encoded discs.

BEFORE OPERATION

LOCATING THE PLAYER

Avoid placing the player in locations subject to extremely high and low temperatures. In particular, do not use the player in a place subject to direct sunlight, a heater or heat outlet as this could adversely affect the player's operation. Also avoid humid and dusty places as this could cause a malfunction. Finally, be sure the player is placed on a sturdy, level surface.

OPEN THE HOOD

The hood can only be opened when the power is turned on. To open the hood:

1. Plug the power cord into the wall socket.
2. Press the power switch to turn power on.
3. Press the REJECT/OPEN key to unlock the hood.
4. Lift up the hood with your hand.

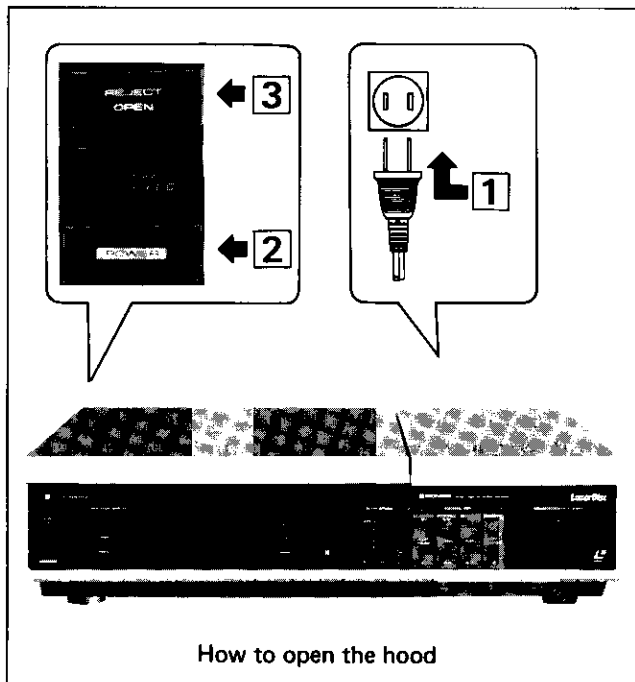

Infrared remote control is possible

With the RU-8210 remote control unit, almost all operations can be controlled from a distance via infrared light.

LSIs used to assure highly reliable operation

To maintain the same excellent quality and ease of operation over many years, the PR-8210 employs sophisticated circuitry and specially developed LSIs to concentrate as many circuit components as possible into one tiny tip.

REMOVE THE SHIPPING SCREW AND LENS CAP

To prevent possible damage to the internal mechanism during shipment, a shipping screw is placed beside the center shaft at the factory. To remove the screw, loosen it with a coin or screwdriver and pull it out with the screw plate.

Next, remove the gray lens cap which is placed over the lens (just to the right of the center shaft) to protect the lens from dust and dirt during shipment.

NOTE:

Store the shipping screw, plate and lens cap with the operating instructions for use if the player has to be moved again. Be sure to replace the screw and plate with the player power on whenever the player is transferred to another place. You should also place the lens cap over the objective lens when the player is not going to be used for a long time to keep the lens free of dirt and dust.

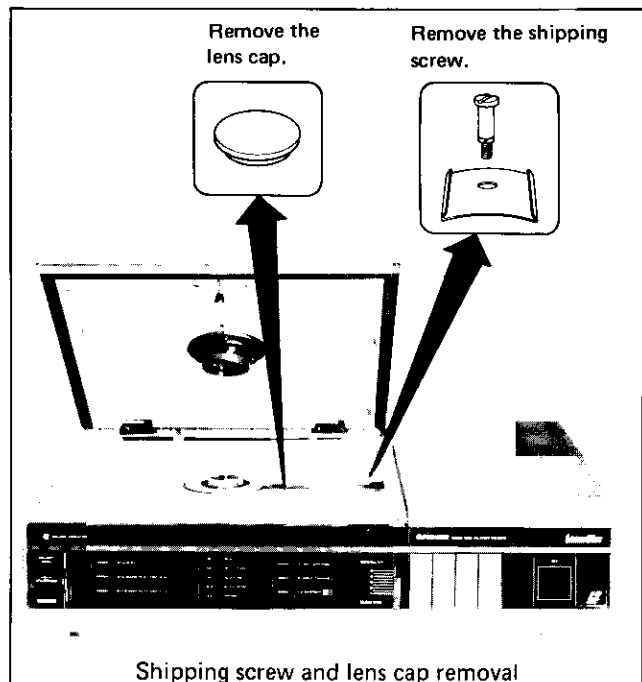

INSERT THE BATTERIES IN THE REMOTE CONTROL UNIT

The RU-8210 remote control unit is packed in a cardboard box inside the carton.

1. Open the battery cover on the back panel.
2. Insert three size "AA" dry batteries in the compartment with their polarities correctly positioned as indicated inside the compartment. The ribbon should be left under the batteries so they can be removed easily. Once the batteries are in, replace the battery cover.
3. Press one of the keys and confirm that the red indicator lights up. There is no on/off switch; the remote control operates only when one of the keys is pressed.

NOTES:

- When the remote control is not going to be used for a long time (more than one month), remove the batteries to prevent possible damage from leakage. If the batteries do leak, wipe the inside of the battery case clean before inserting new batteries.

- Do not use old and new batteries together; always replace all three batteries at once.
- Do not place books or other objects on the remote control unit since they might depress the keys and run down the batteries.

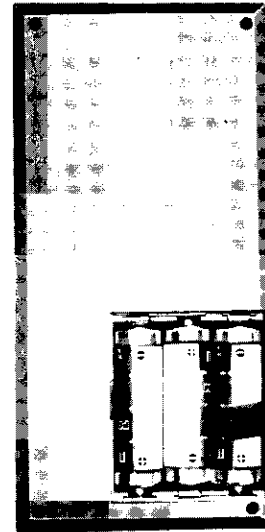

REAR PANEL FACILITIES

① CONTROL

This terminal is used as an I/O port when the player is controlled by a microcomputer.

② AUDIO OUT

These jacks provide the left and right channel audio signals for connection to a stereo hi-fi system.

③ VIDEO OUT

The terminal is only for connection to a color video monitor TV (that has a video input terminal). It provides the direct video signal. This terminal is not for conventional TV sets.

④ ANTENNA IN 75 OHM UNBAL.

If your VHF antenna cable is a 75-ohm coaxial cable type, connect it to this terminal.

⑤ CH.3/4 VHF OUT

This terminal provides audio and video signals which are converted to VHF channel 3 or channel 4 by the built-in VHF converter.

⑥ VHF CHANNEL SELECTOR

This slide switch is for selecting a VHF output channel. It has been set to channel 3 at the factory but can be changed to channel 4. Set to the channel which is not used for commercial TV broadcasts in your area.

⑦ POWER CORD

Plug this into a wall socket.

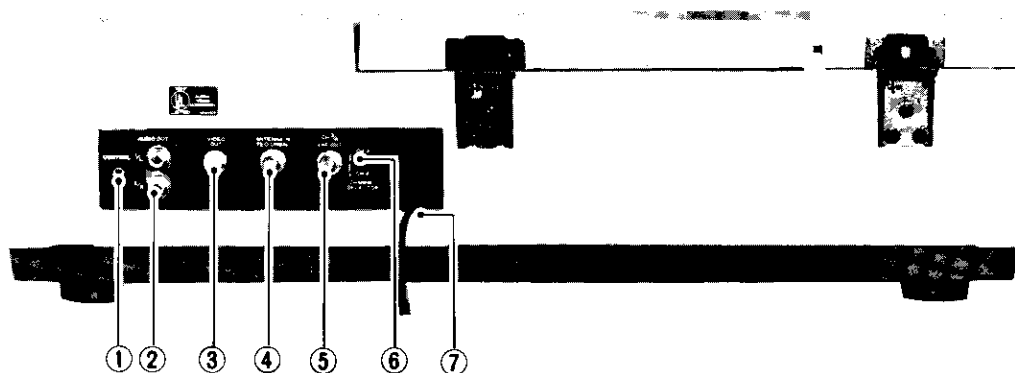

High quality stereo sound

Pioneer videodiscs have two completely discrete audio channels encoded in FM to permit discs to include stereo sound or bilingual commentary.

CX noise reduction system

The PR-8210 can take full advantage of the widened dynamic range and higher S/N ratio of CX encoded discs.

BEFORE OPERATION

LOCATING THE PLAYER

Avoid placing the player in locations subject to extremely high and low temperatures. In particular, do not use the player in a place subject to direct sunlight, a heater or heat outlet as this could adversely affect the player's operation. Also avoid humid and dusty places as this could cause a malfunction. Finally, be sure the player is placed on a sturdy, level surface.

OPEN THE HOOD

The hood can only be opened when the power is turned on. To open the hood:

1. Plug the power cord into the wall socket.
2. Press the power switch to turn power on.
3. Press the REJECT/OPEN key to unlock the hood.
4. Lift up the hood with your hand.

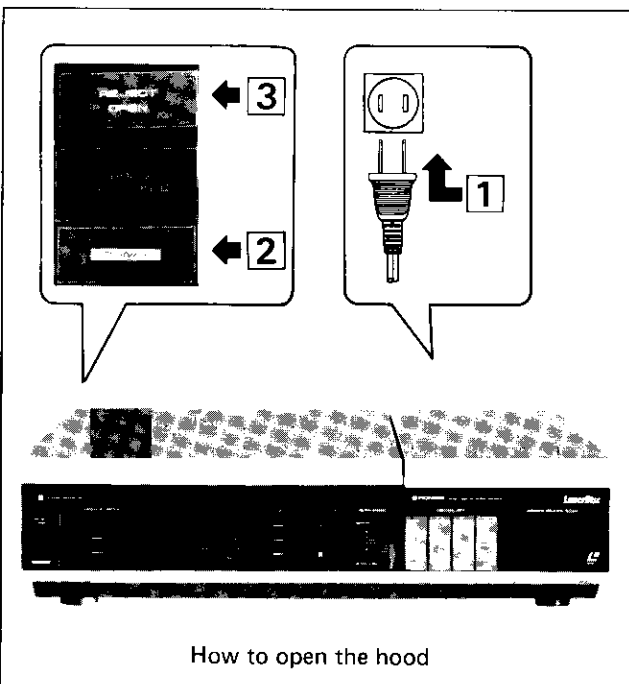

Infrared remote control is possible

With the RU-8210 remote control unit, almost all operations can be controlled from a distance via infrared light.

LSIs used to assure highly reliable operation

To maintain the same excellent quality and ease of operation over many years, the PR-8210 employs sophisticated circuitry and specially developed LSIs to concentrate as many circuit components as possible into one tiny tip.

REMOVE THE SHIPPING SCREW AND LENS CAP

To prevent possible damage to the internal mechanism during shipment, a shipping screw is placed beside the center shaft at the factory. To remove the screw, loosen it with a coin or screwdriver and pull it out with the screw plate.

Next, remove the gray lens cap which is placed over the lens (just to the right of the center shaft) to protect the lens from dust and dirt during shipment.

NOTE:

Store the shipping screw, plate and lens cap with the operating instructions for use if the player has to be moved again. Be sure to replace the screw and plate with the player power on whenever the player is transferred to another place. You should also place the lens cap over the objective lens when the player is not going to be used for a long time to keep the lens free of dirt and dust.

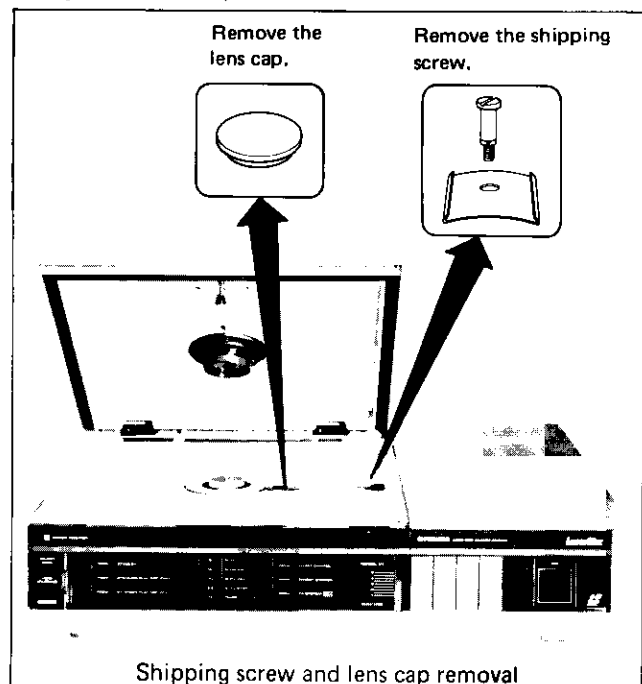

INSERT THE BATTERIES IN THE REMOTE CONTROL UNIT

The RU-8210 remote control unit is packed in a cardboard box inside the carton.

1. Open the battery cover on the back panel.
2. Insert three size "AA" dry batteries in the compartment with their polarities correctly positioned as indicated inside the compartment. The ribbon should be left under the batteries so they can be removed easily. Once the batteries are in, replace the battery cover.
3. Press one of the keys and confirm that the red indicator lights up. There is no on/off switch; the remote control operates only when one of the keys is pressed.

NOTES:

- When the remote control is not going to be used for a long time (more than one month), remove the batteries to prevent possible damage from leakage. If the batteries do leak, wipe the inside of the battery case clean before inserting new batteries.

- Do not use old and new batteries together; always replace all three batteries at once.
- Do not place books or other objects on the remote control unit since they might depress the keys and run down the batteries.

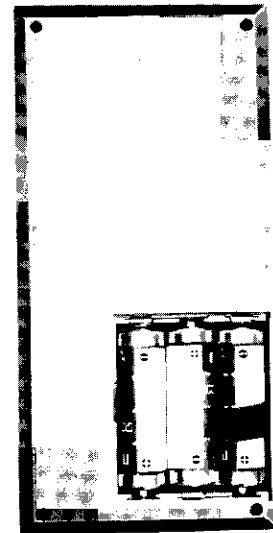

REAR PANEL FACILITIES

① CONTROL

This terminal is used as an I/O port when the player is controlled by a microcomputer.

② AUDIO OUT

These jacks provide the left and right channel audio signals for connection to a stereo hi-fi system.

③ VIDEO OUT

The terminal is only for connection to a color video monitor TV (that has a video input terminal). It provides the direct video signal. This terminal is not for conventional TV sets.

④ ANTENNA IN 75 OHM UNBAL.

If your VHF antenna cable is a 75-ohm coaxial cable type, connect it to this terminal.

⑤ CH.3/4 VHF OUT

This terminal provides audio and video signals which are converted to VHF channel 3 or channel 4 by the built-in VHF converter.

⑥ VHF CHANNEL SELECTOR

This slide switch is for selecting a VHF output channel. It has been set to channel 3 at the factory but can be changed to channel 4. Set to the channel which is not used for commercial TV broadcasts in your area.

⑦ POWER CORD

Plug this into a wall socket.

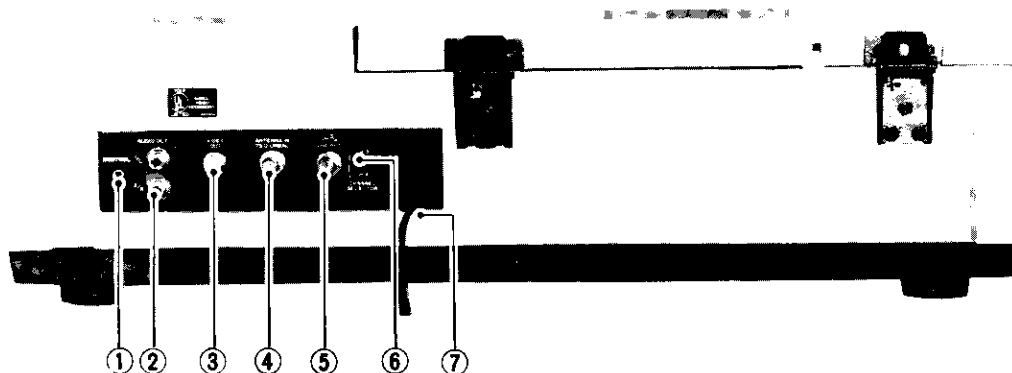

CONNECTIONS

BASIC COMBINATION (PR-8210 and TV)

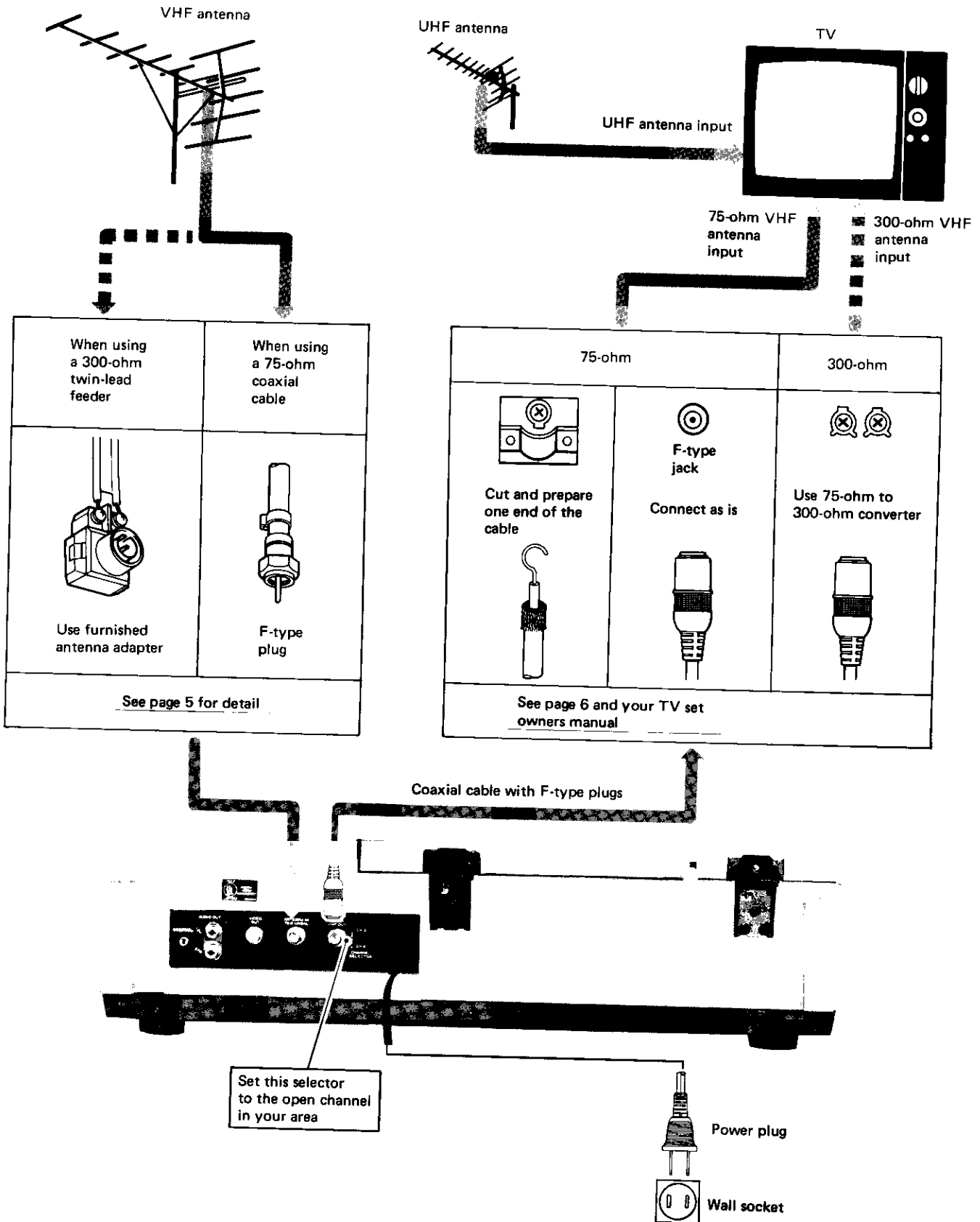

1. Connecting the VHF antenna

Disconnect the VHF antenna cable from your TV set and connect it to the rear panel ANTENNA IN terminal of the player. VHF signals from the antenna and the player are now automatically switched by the power switch of the player.

When using a 300-ohm twin-lead (flat) type cable:

1. Remove the cable from the VHF antenna input of your television set.
2. Connect the cable to the 300-ohm end of the furnished antenna adapter.
3. Then connect the antenna adapter (F-type plug) to the ANTENNA IN terminal on the player.

NOTES:

- Leave the UHF antenna cable connected to the TV set.
- If you are using a VCR with a built-in TV tuner, connect the output cable from the VCR VHF output jack to the ANTENNA IN jack of the player.

When using a 75-ohm coaxial (round) cable:

1. Remove the cable from the VHF antenna input of your television set.
If there is no F-type plug on the end of the cable, attach an F-type plug.
2. Connect the cable to the ANTENNA IN terminal on the player.

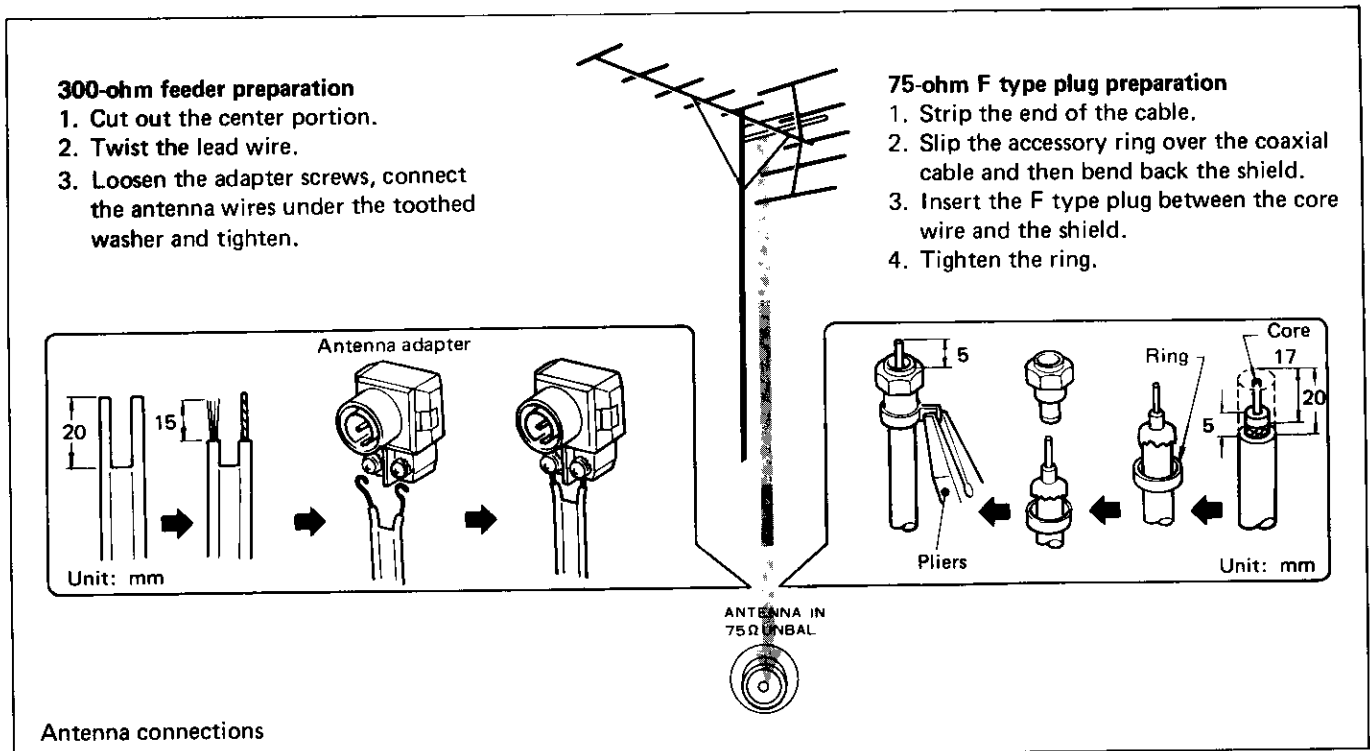

2. Television connections

A coaxial cable with F-type plugs on both ends is supplied with the player. Use it for connecting the player to the TV set.

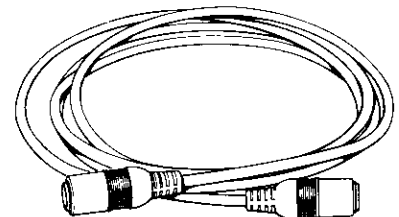

Using the 75-ohm VHF antenna input:

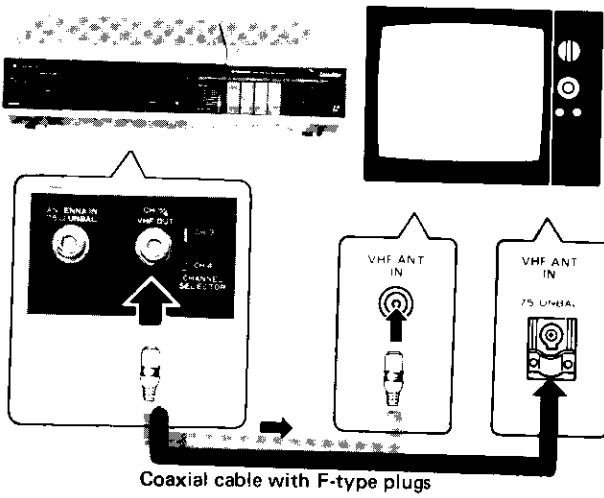

NOTE:

- If your TV set does not have an F-type VHF antenna input terminal, cut one end of the cable as shown below before connecting the player to the TV set.

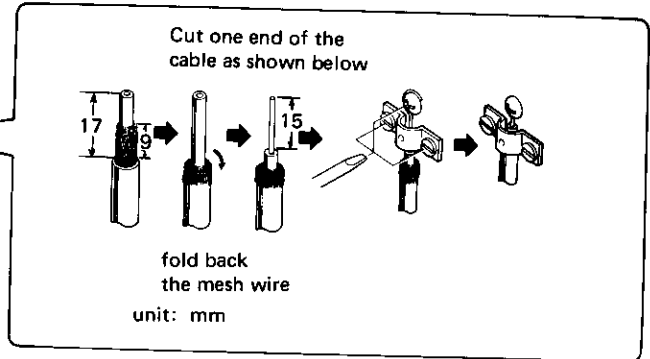

Using the 300-ohm VHF antenna input (when there is no 75-ohm VHF antenna terminal):

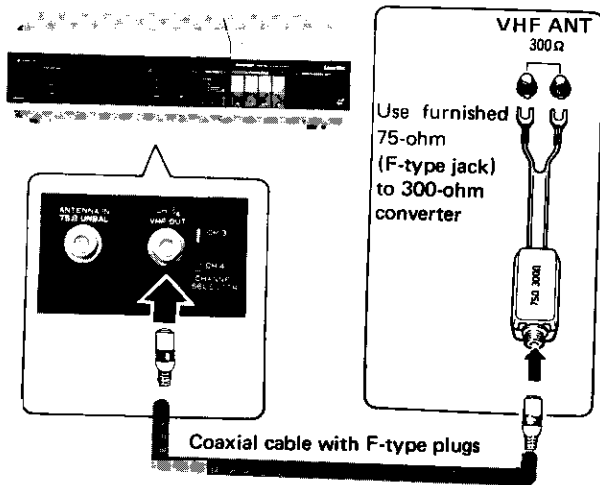

NOTE:

Since the exact manner of connecting the antenna cable differs for various manufactures, consult your TV owner's manual.

3. Setting the CHANNEL SELECTOR

Next set the CHANNEL SELECTOR on the player to channel 3 or 4, whichever is not used for commercial TV broadcasts in your area. Then set your TV to the same channel.

4. Plug in the power cord

The AC power cord of the player should be plugged into a wall socket (120V, 60Hz). This completes the basic connection procedure for videodisc playback through your TV.

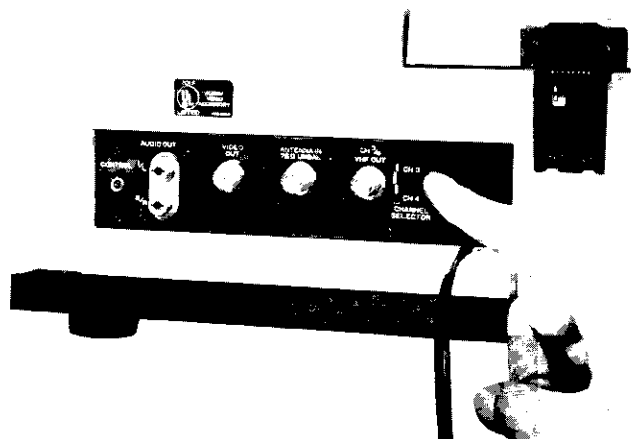

Channel selector

OPTIONAL CONNECTIONS

1. Stereo amplifier

The player can reproduce two channel stereo hi-fi signals from videodiscs. To take full advantage of this capability, use the two audio connection cords to connect AUDIO OUT jacks on the player to the left and right channel AUX input (or tuner input) jacks on your stereo amplifier or receiver.

Place the TV set (to which you have the cable connected) between the stereo speakers and shut off the TV set's volume control for best results.

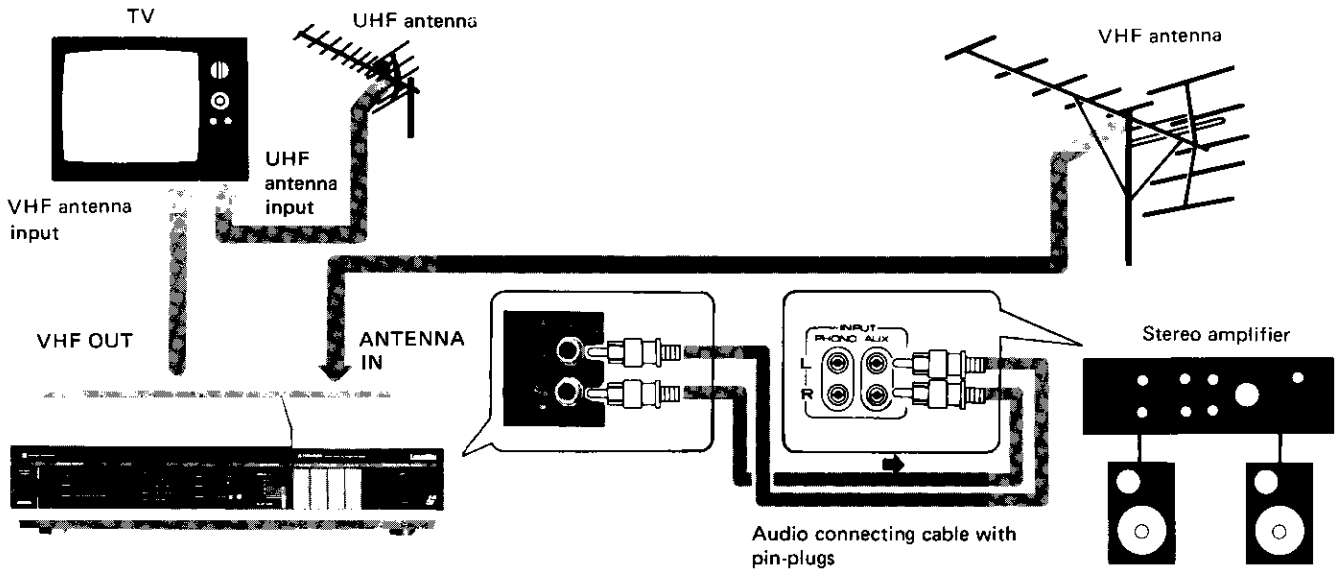

2. Video monitor TV

If you are using a video monitor TV (equipped with a video input terminal), use the accessory coaxial cable to connect the VIDEO OUT terminal on the player to the video input terminal on the monitor TV (terminated video input terminal). In this case, audio outputs on the player must be connected to audio inputs of the monitor TV or to a stereo system for audio reproduction.

NOTE:

The video input terminal on the monitor TV in use may differ from the F type jack. In this case, exchange the plug at one end of the coaxial cord for one that fits properly.

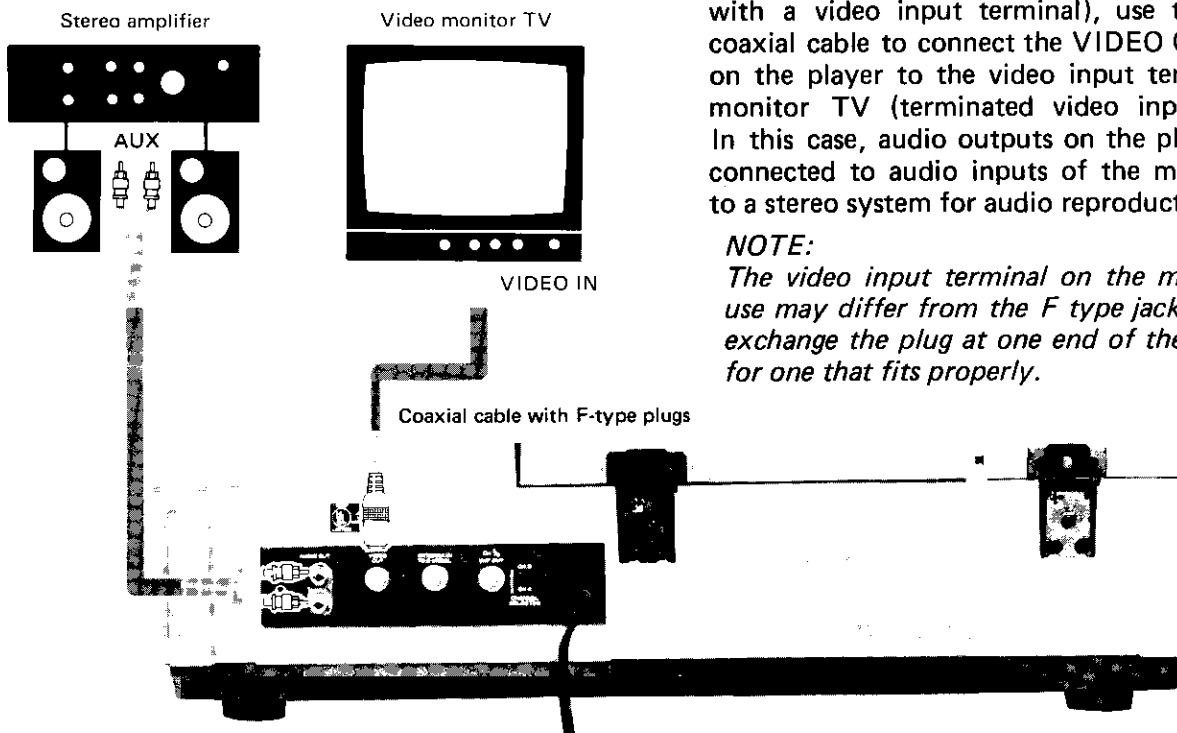

PARTS AND CONTROLS

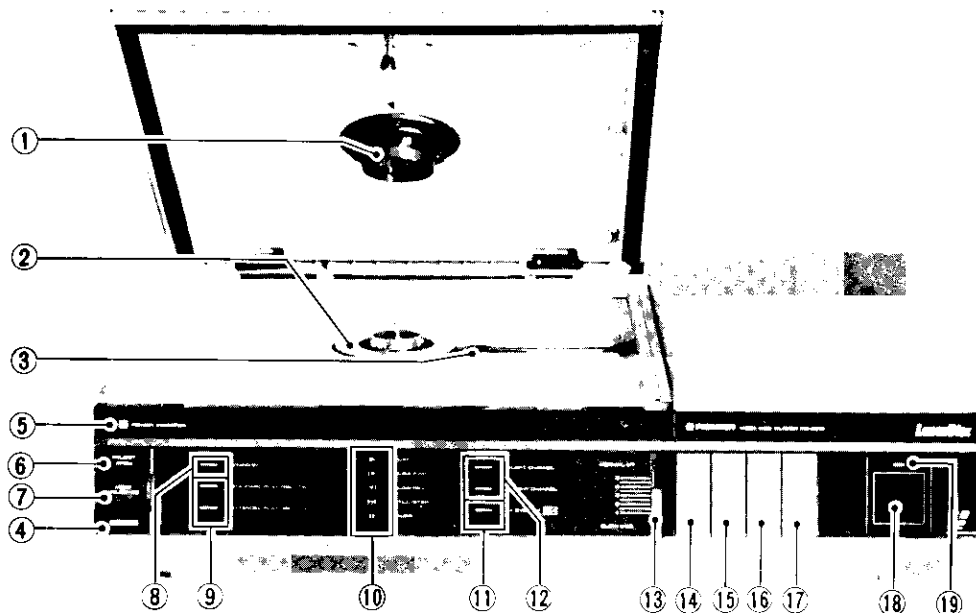

① DISC CLAMP

This holds the disc onto the turntable when the hood is closed to assure that the disc rotates smoothly.

② TURNTABLE

Place a disc on this platter so it fits over the raised center hub. The turntable is directly connected to the motor so the precise speed is maintained at all times.

③ OBJECTIVE LENS

This lens focuses the laser beam onto the disc and picks up the beam reflected back from the disc. Note that the lens surface must be kept clean in order to maintain optimum performance.

④ POWER

Press this switch to turn power on and off.

⑤ POWER INDICATOR

This lights up to show the power is on.

⑥ REJECT/OPEN

Press this key to cut off operation and to open the hood.

⑦ HOOD UNLOCKED INDICATOR

This indicator lights up when the hood is open and goes out when the hood is completely closed and locked. Note that the player can not be operated until this indicator goes out.

⑧ STAND BY INDICATOR

This indicator flashes on and off during those periods when some time is required for the player to switch to the next commanded function mode. For example: When the PLAY key (or ► marked end of the PLAY/PAUSE key) is pressed after REJECT, during search mode, during the return period.

⑨ DISC INDICATORS

A few moments after the PLAY key (or ► marked end of the PLAY/PAUSE key) has been pressed, one of these indicators shows whether a CAV or CLV disc is being played.

⑩ PLAYBACK MODE INDICATORS

One of these indicators shows the playback mode presently selected.

⑪ CX INDICATOR

This indicator lights when the CX noise reduction system is activated.

⑫ AUDIO INDICATORS

These indicators show whether only one or both audio channels are being heard.

⑬ SLOW SPEED CONTROL

Use this control to adjust the speed of slow motion playback.

14 PLAY/PAUSE

Pressing the ► mark on the upperside of the switch starts playback or returns to normal play mode from another mode. To temporarily stop playback, press the || mark on the lower side of the switch. This stops the pickup, turns off both picture and sound. Pressing the || mark again cancels the pause mode and returns the player to the mode it was in previously.

15 SCAN

Use this key to quickly locate a particular part of the disc program or skip a part of the program.

►► : press to scan quickly forward

◄◄ : press to scan quickly backward

16 AUDIO 1/L, 2/R

Use this key to turn sound off and on in the left or right channel. Pressing either end of the key turns off sound in that channel; press again to turn sound back on.

17 CX SYSTEM

This key turns the CX noise reduction system on and off. Turn the CX system on when playing a CX encoded disc.

18 REMOTE CONTROL RECEIVER

This is the reception point for the remote control unit infrared signal.

19 REMOTE CONTROL INDICATOR

This indicator lights when one of the control keys on the player or the remote control unit has been pressed. Watch this indicator carefully during remote control operations to be sure your command has been received.

20 PLAY

To begin playing a videodisc or resume normal play mode after another playback mode, press this key.

21 PAUSE

Press this key to temporarily halt videodisc operation. The pause mode is released by pressing the pause key again.

22 REJECT

Press this key to cut off operation.

23 AUDIO 1/L, 2/R

These are on/off keys for the two audio channels.

24 ◀X3 FAST 3X▶

Press the right end of this key for triple-speed forward play; press the left end for triple-speed reverse play.

25 ◀SLOW▶

This key is used for slow motion playback. Press the right end of the key for slow forward play; press the left end of the key for slow reverse play.

26 ◀STILL/STEP▶

This is used for single frame play and frame-by-frame play.

27 FRAME

This key is used to display or erase frame number (elapsed time) on the TV screen.

28 CHAPTER

This key is used to display or erase chapter number on the TV screen.

29 DIGIT KEYS

These keys are used to select the desired frame and chapter number for the search mode.

30 SEARCH

This is used to find specific frame or chapter on the videodisc.

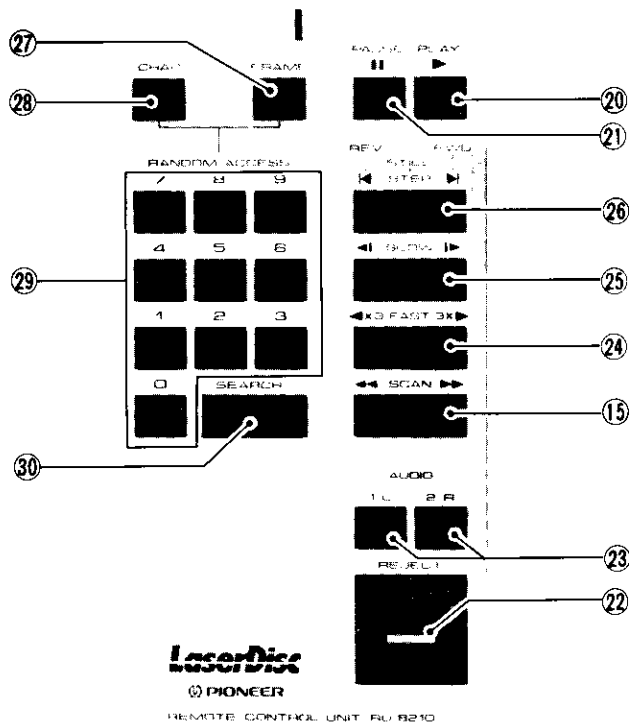

OPERATION

TO START PLAYING A VIDEODISC

1. Press the power switch to turn on the player.
2. Press the REJECT/OPEN key to unlock the hood.
3. Raise the hood. Be careful not to force the hood beyond its normal fully open position.

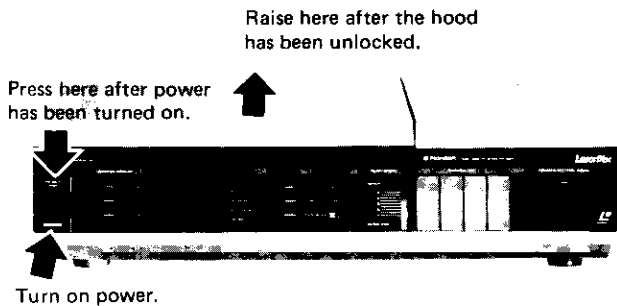

4. Turn on the TV set and set the channel to the same channel number (VHF channel 3 or 4) as the player's rear panel CHANNEL SELECTOR.
If a stereo system is being used, turn the TV set volume control all the way down.

NOTE:

- Adjust the fine tuning control on the TV set to obtain the sharpest picture possible. This is particularly important when using the player for the first time or when using the player with a different TV for the first time.
5. Insert a disc.
The label of the side to be played should be facing up.

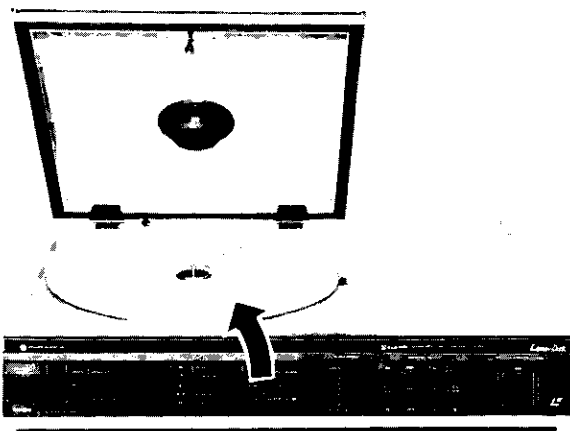

6. Close the hood so that it clicks shut.



7. Press the ► marked end of the PLAY/PAUSE key on the player (or the PLAY key on the remote control unit).
The disc will begin to rotate and the stand by indicator will begin to flash on and off. In a few seconds, the disc will reach its rated speed, a picture will appear on the TV screen and the stand by indicator will go out.

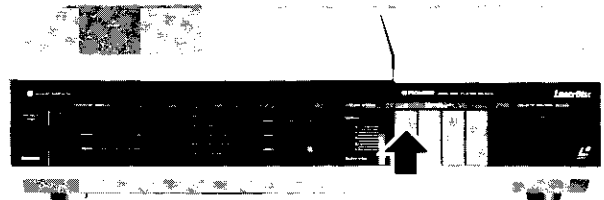

NOTES:

- If a single-side disc is adversely played on the side without a program, the player will not operate.
- The STILL/STEP, SLOW, FAST (three times normal speed) and FRAME NUMBER SEARCH functions do not operate for extended play discs.

TO STOP PLAYING A VIDEO DISC

1. Press the REJECT/OPEN key (on the player or REJECT key on the remote control unit).

The stand by indicator will begin flashing on and off, the disc will stop rotating and the pickup will return to its starting position.



2. Open the hood.
Once the stand by indicator has gone out, press the REJECT/OPEN key on the player to unlock the hood.

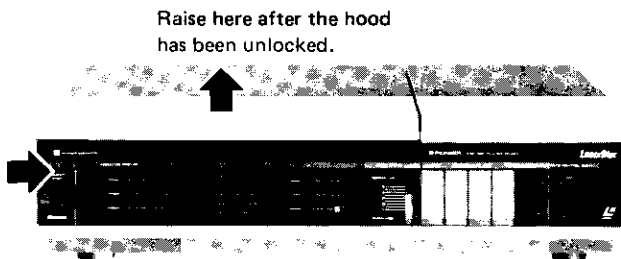

3. Remove the disc.
Raise the hood and take out the disc. Be sure to put the disc back in its protective jacket.

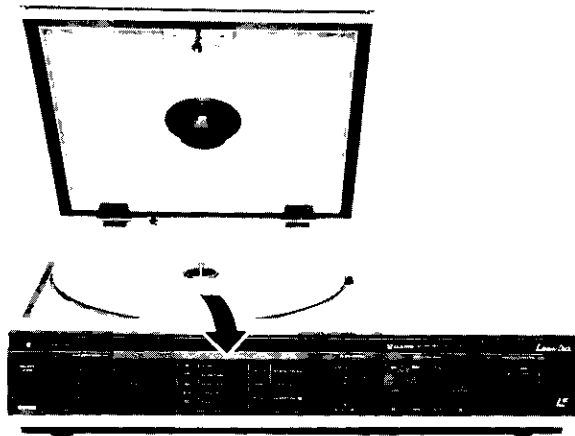

4. Close the hood and turn the power off.

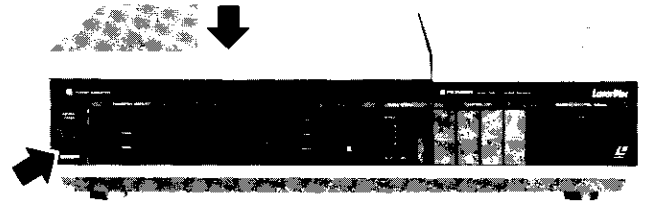

TO WATCH A TV BROADCAST

We suggest that you connect your VHF antenna lead directly to the ANTENNA IN terminal on the player. This will allow automatic switching between videodisc playback and regular TV reception. To watch television programs, turn off power to the player and use your TV set as you normally do. The signal from the VHF antenna will pass through the player and go on to the TV set. Channels 2 to 13 can not be seen when the player power switch on.

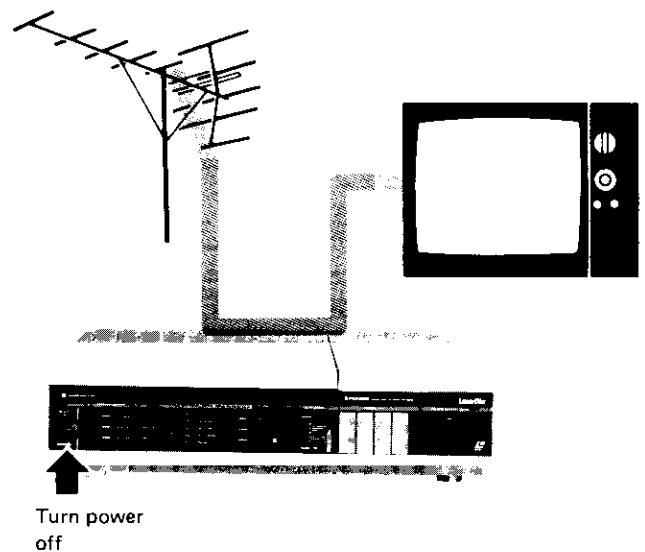

SCAN

This function is useful for locating a particular section of a program in a short time. Once playback has begun, press either end of the SCAN key on the player (or the remote control unit).

Scanning continues in the forward direction for as long as you keep the ►► marked end of the SCAN key depressed. Likewise, scanning continues in the reverse direction for as long as you keep the ◀◀ marked end of the SCAN key depressed. The player returns to the previous mode when you release the SCAN key.

AUDIO 1/L-2/R

Once playback has begun, the 1/L and 2/R audio indicators will light up to show that sound is being produced from both channels recorded on the disc. Press either end (1/L or 2/R) of the AUDIO key to turn off the sound from the channel you are not using. This will also turn off the indicator of the channel. Press the same end again to turn on the sound from that channel again, the indicator will also come back on.

NOTES:

- *Sound is only heard during normal playback mode. No sound is heard during any of the other playback modes. Also, no sound is heard when both channels have been turned off (neither audio indicator is lit).*
- *When one audio channel is in use, the sound is fed to both audio outputs.*

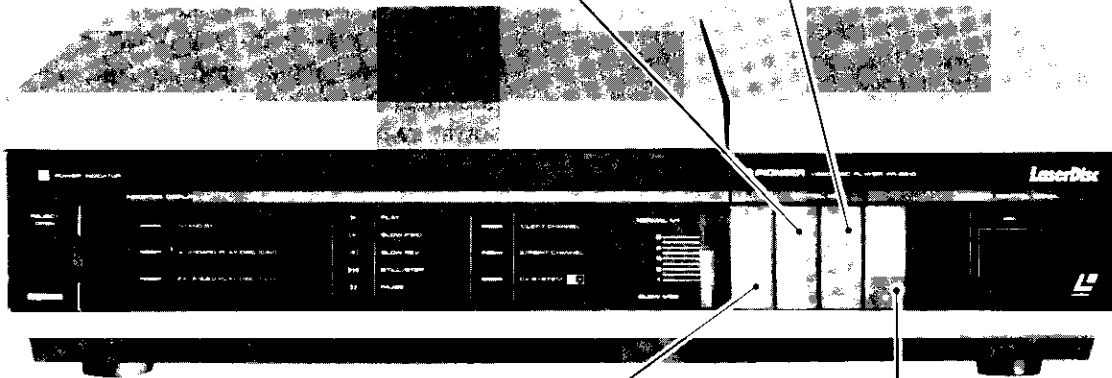

PAUSE

Playback is interrupted at the point where you press the || marked end of the PLAY/PAUSE key on the player (or the PAUSE key on the remote control unit). The picture will disappear and the pickup will halt at its location when the PAUSE key was pressed. The pause indicator light will show the player is in the pause mode. The pause mode is released by pressing either end of the PLAY/PAUSE key, the SCAN key, and the SEARCH key (on the remote control unit).

CX NOISE REDUCTION SYSTEM

The CX noise reduction system is used to reduce noise which may be caused during recording of the disc and thus it improves signal-to-noise ratio. When a disc marked with the CX symbol is to be played, press the CX key on the front panel. An indicator light will confirm that CX decoder is operational.

While the CX decoder will significantly improve the dynamic range of a CX disc, the disc can be played without decoding quite satisfactory. However, discs with no CX symbol should not be played with the CX control on. The function can be disabled by pressing the CX key making sure that the indicator lamp goes out.

AUTOMATIC PICTURE STOP

The player has a function called "automatic picture stop" which freezes the program automatically at the frame designated by a specially recorded code in the videodisc. The freeze frame occurs when the player is in either normal play or slow motion mode.

When the automatic picture stop has occurred, simply press the ► marked end of the PLAY/PAUSE key (or the PLAY key on the remote control unit) or the SLOW key to release the freeze frame.

OPERATION WITH THE REMOTE CONTROL UNIT

With the RU-8210 remote control unit, almost all operations described up to now and many others can be controlled from the comfort of your viewing position. The remote control can be used up to a distance of about twenty feet from the player. Always point the front of the remote control toward the reception point on the player before pressing one of the keys. Commands are transmitted by an infrared beam and the remote control indicator just above the remote control receiver lights to confirm that a command has been received.

NOTES:

- Remote control commands may not reach the player if there are obstacles between the remote control unit and the player or if the player is placed at an angle to the remote control unit.
- Do not place the appliances that project infrared light near the player or use other infrared type remote control units as these could be sensed as commands by the player. Also be sure other appliances controlled by infrared type remote controls are out of the effective range of the RU-8210 remote control unit.
- The battery life differs greatly depending on how often the RU-8210 remote control unit is used. As the batteries become weaker, the effective distance of the unit will become shorter. Replace the batteries when the player does not execute a command even though the indicator on the remote control unit lights when a key is pressed or when the effective distance becomes too short.
- The remote control unit will not activate when the CONTROL terminal on the rear panel is plugged in.

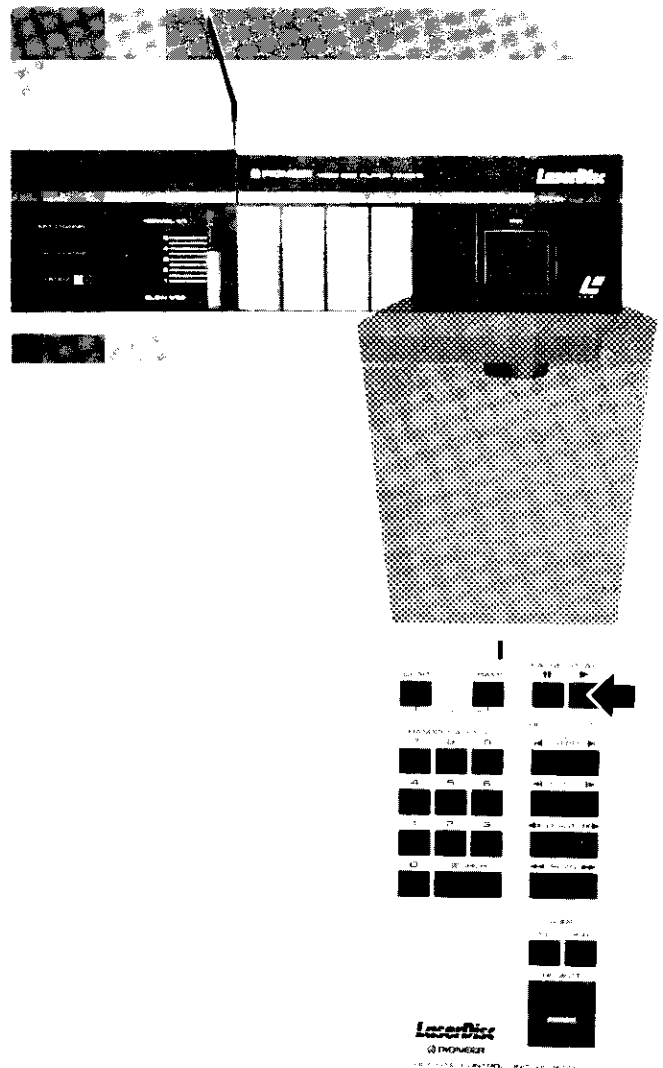

FRAME NUMBER DISPLAY

On standard play discs, the frames are numbered from "1" upward to the outermost track. The numbers of the frames being shown can be displayed by pressing the FRAME key. To turn the frame display off, press the FRAME key again. Frame numbers are not displayed for extended play discs. Instead, the time elapsed since the beginning of the program is displayed digitally by pressing the FRAME key. The two right digits show minutes and the left one shows hours.

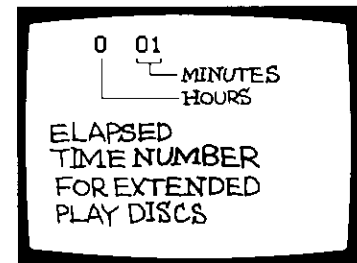
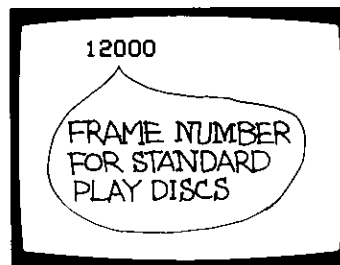

CHAPTER NUMBER DISPLAY

Some videodiscs are indexed with chapter numbers. The chapter number can be displayed by pressing the CHAPTER key. To turn the chapter display off, press the CHAPTER key again.

NOTE:

- On discs with no chapter numbers, nothing will happen when the CHAPTER key is pressed, and consequently, the chapter number search and chapter stop functions can not be performed.

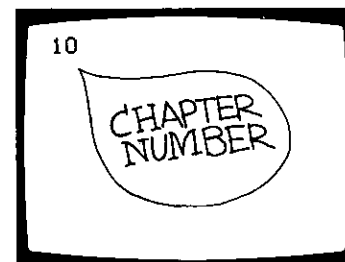

CHAPTER STOP

When playing a disc that has chapters, it is convenient to be able to skip to the beginning of the next chapter or the beginning of the chapter presently being played. This is done by pressing either end of the SCAN key while the player is in the chapter display mode. Hold the SCAN key (forward or reverse) down until the pickup automatically stops at the beginning of the next (or present) chapter.

At this point, playback will resume in the same mode that was being used when the SCAN key was pressed. Once the beginning of the next (or present) chapter has been reached, release the SCAN key; scanning will not continue even if you keep the SCAN key depressed. To continue to the next chapter in either direction, once release the SCAN key and begin the chapter stop procedure again.

◀STILL/STEP▶

Press either end of this key to stop the picture at the frame being shown at that instant. Next, press the right or left end of the key to advance or backtrack one frame at a time. Each time the right or left end is pressed, the picture will advance or backtrack to the adjacent frame.
To release the freeze frame, press the PLAY key.

NOTE:

- *STILL/STEP function is only possible with standard play discs; it does not operate with extended play discs.*

◀SLOW▶

The picture advances slowly by pressing the right end of the SLOW key and goes backward slowly by pressing the left end of the SLOW key. The slow motion play mode indicator will light during slow motion playback. The slow motion speed can be adjusted by sliding the slow speed control up or down. In the uppermost position, the speed is 30 frames per second, the same as normal play mode. In the lowest position, the speed is approximately one frame per second. Any speed from one to thirty can be set with this control.

To release the slow motion play mode, press the PLAY key.

NOTE:

- *Slow motion playback is only possible with standard play discs. This function will not operate when an extended play disc is being played.*

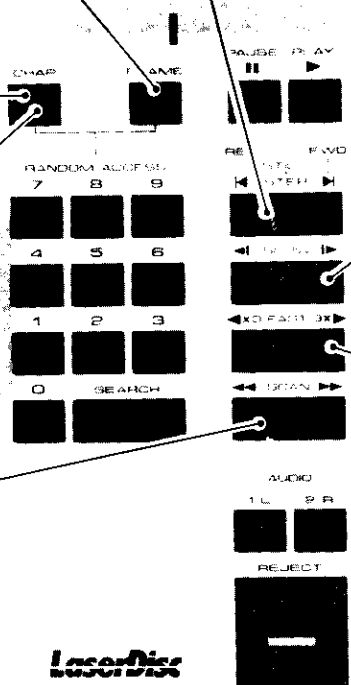
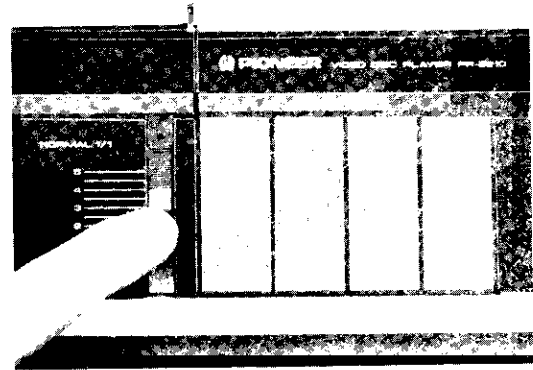

LaserDisc

PIONEER

REMOTE CONTROL UNIT BU-B210

◀X3 FAST 3X▶

The picture advances at three times normal speed while the right end of this key is held down and goes backward at three times normal speed while the left end of this key is held down.

NOTE:

- *Fast play is only possible with standard play discs. This function will not operate when an extended play disc is being played.*

FRAME NUMBER SEARCH (STANDARD PLAY DISC ONLY)

This function gives you access to a specified frame number. Frame number search can only be performed with standard play discs.

For example, to search for frame number 12340:

1. Press the SEARCH and FRAME keys.
Playback will stop and the player will wait for the frame number to be entered.
2. Enter the frame number using the DIGIT keys.
Press keys 1, 2, 3, 4, 0 in that order.
If you make a mistake pressing the DIGIT keys, press the FRAME key again and enter the correct frame number.
If a frame number higher than the highest frame on the disc is entered, the outermost track on the disc will be searched.
3. Press the SEARCH key.
The pickup will move to specified frame. During this time, there will be no picture and the stand by indicator will flash on and off. When the specified frame has been located, the frame will be played in the still frame mode.

NOTE:

- If you decide to cancel the search mode after beginning the input procedure, simply press the PLAY key.

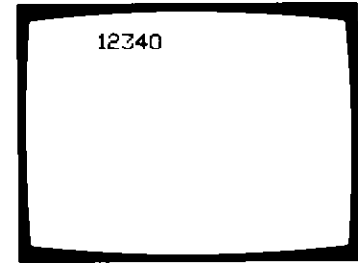
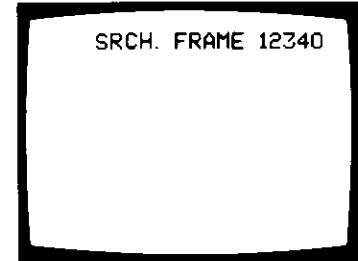
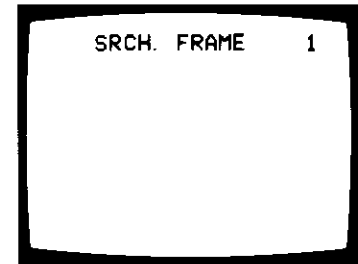
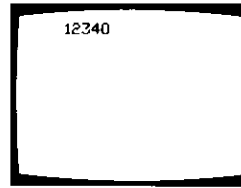

ELAPSED TIME NUMBER SEARCH (EXTENDED PLAY DISC ONLY)

This function gives you to access to the beginning of an elapsed time number.

For example, to search for 12 minutes:

1. Press the SEARCH and FRAME keys.
Playback will continue as before.
2. Enter the elapsed time using the DIGIT keys.
If you make a mistake pressing the DIGIT keys, press the FRAME key again and enter the correct elapsed time number. If a number higher than the last elapsed time on the disc is entered, the outermost track on the disc will be played.
3. Press the SEARCH key.
The pickup will move to the beginning of the specified elapsed time number. During this time, there will be no picture and the stand by indicator will flash on and off. When the beginning of the specified elapsed time number has been located, the player will then begin normal playback.

NOTE:

- If you decide to cancel the search mode after the input procedure, simply press the PLAY key.

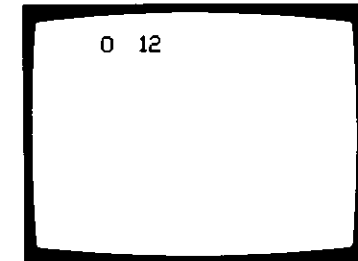
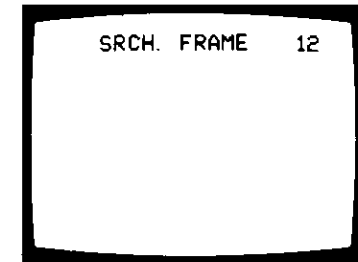
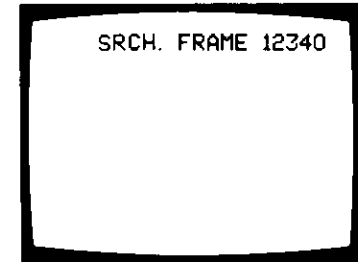
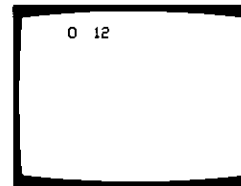

CHAPTER NUMBER SEARCH

This function gives you access to the very beginning of a specified chapter number.

For example, to search for chapter 3:

1. Press the SEARCH and CHAP. keys.
If a standard play disc is being played, playback will stop at that point and switch to the still frame mode. If an extended play disc is being played, playback will continue as before.
2. Enter the chapter number using the DIGIT key(s). If you make a mistake pressing the DIGIT key(s), press the CHAP. key again and enter the correct chapter number. If a chapter number higher than the last chapter on the disc is entered, the outermost track on the disc will be played.

3. Press the SEARCH key.

The pickup will move to the beginning of the specified chapter. During this time, there will be no picture and the stand by indicator will flash on and off. When the beginning of the specified chapter has been located, the first frame of the chapter will be played in the still frame mode on standard play discs and normal play will begin on extended play discs.

NOTES:

- Once frame (elapsed time) number or chapter number search has been performed, the PR-8210 will retain the specified frame (elapsed time) or chapter in its memory until the power is turned off or another frame (elapsed time) or chapter is entered. Consequently, if the SEARCH key is pressed twice in a row, the frame (elapsed time) or chapter previously set will be located and played again.
- If you decide to cancel the search mode after beginning the input procedure, simply press the PLAY key.

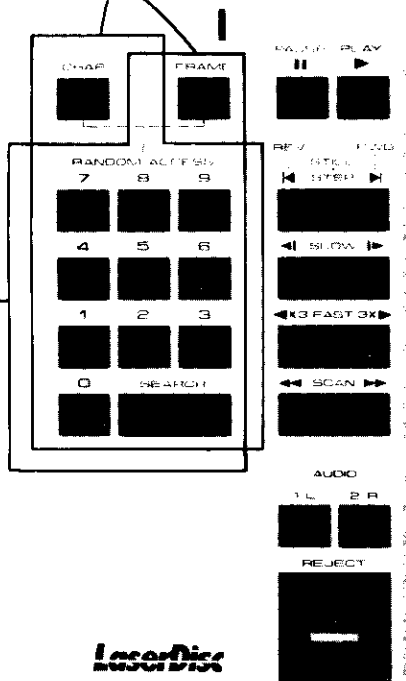

LaserDisc

PIONEER

REMOTE CONTROL UNIT PR-8210

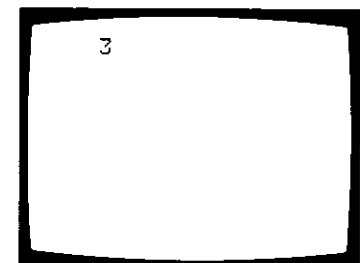
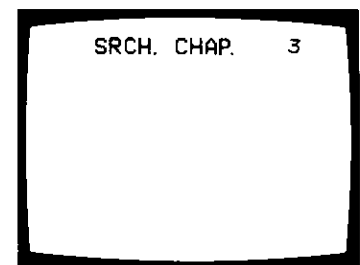
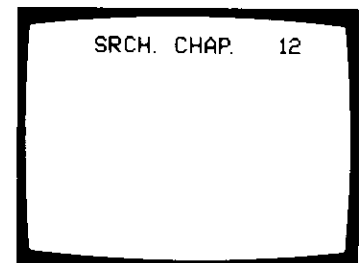
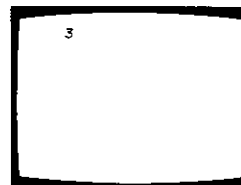

TROUBLESHOOTING

Before concluding that the player is out of order, please refer to this troubleshooting guide to make sure that there is not a simple remedy for the problem. The vast majority of performance problems have their source in set up errors

bad connections to other equipment, or malfunctions of other equipment (TV, stereo system).

Find the trouble symptom on the chart below, and try the suggested remedies.

SYMPTOM	CAUSE	REMEDY
Hood does not open.	<ul style="list-style-type: none"> • Power cord is not properly plugged into AC wall socket. • Power switch is not turned on. • Latch is not released. 	<ul style="list-style-type: none"> • Plug in power cord. • Turn on power switch. • Press REJECT/OPEN key.
Disc does not rotate.	<ul style="list-style-type: none"> • Power is not on. • Hood is not shut completely 	<ul style="list-style-type: none"> • Plug in power cord. • Turn on power switch. • Push hood and close it firmly so latch locks.
Disc stops rotating soon after starting.	<ul style="list-style-type: none"> • You are playing the unrecorded side of a disc. 	<ul style="list-style-type: none"> • Turn over disc.
Disc rotates but there is no picture.	<ul style="list-style-type: none"> • TV is not turned on. • Wrong connection from player to TV. • TV set is not tuned to channel 3 or 4. • Player VHF CHANNEL SELECTOR is at the wrong setting. • Player is in the PAUSE mode. 	<ul style="list-style-type: none"> • Turn on TV. • Make correct connections. • Set TV to the channel (3 or 4) that is not used for TV broadcasting in your area. • Set to same channel. • Press the PLAY key.
Picture quality is bad.	<ul style="list-style-type: none"> • Bad connections between player and TV set. • Player VHF out channel is different from TV channel. • TV fine tuning has not been adjusted. • Poor disc. 	<ul style="list-style-type: none"> • Check all connections, particularly F type plugs. • Both TV and player must be set to the same channel (3 or 4) which is not used for TV broadcasting in your area. • Adjust TV fine tuning knob for optimum picture quality. • Try playing a different disc. If other discs give good quality, the problem is with that particular disc.
TV no longer receives other channels after it has been connected to the player.	<ul style="list-style-type: none"> • Antenna cable has not been connected. • Power on the player is being turned on. 	<ul style="list-style-type: none"> • Connect VHF antenna cable to ANTENNA IN terminal on the player. • To view regular TV broadcasts, remember to turn off the power on the player.
A particular part of a particular disc is not reproduced properly.	<ul style="list-style-type: none"> • Damaged disc. 	<ul style="list-style-type: none"> • Press the SCAN key to skip over damaged portion.
Remote control does not work.	<ul style="list-style-type: none"> • Remote control unit batteries are weak. • An obstacle between the player and the remote control unit. • Remote control unit is not located in a good direction for transmission. 	<ul style="list-style-type: none"> • Replace batteries. • Remove the obstacle or shift the remote control. • Locate the remote control unit in front of the player.

SPECIFICATIONS

General

System and disc spec.
 Comply with MCA Philips specifications

*1 Maximum playing time

. Standard play videodisc: 30 minutes/side
 Extended play videodisc: 60 minutes/side

Spindle motor revolutions

. Standard play videodisc: 1800 RPM
 Extended play videodisc: 1800 RPM
 (inner circumference)
 to 600 RPM (outer circumference)

Laser 6328 angstrom, He-Ne 1mW

Video Characteristics

Video response NTSC specification

Video output

Level . . . 1Vp-p nominal, sync. negative, terminated
 Impedance 75 ohm unbalanced
 Terminal F type jack

Signal to noise ratio More than 42dB

VHF output

Channel Channel 3 or 4 (switchable)
 Level More than 60dBμ (comply with
 FCC specifications)
 Impedance 75 ohm unbalanced
 Terminal F type jack

Audio Characteristics

Audio output Two channels; stereo or two
 individual channels

Level 650mV nominal (1kHz 100% mod.
 50 kilohms terminated)

Impedance Less than 2.2 kilohms unbalanced
 Terminal Stereo pinjacks

Total harmonic distortion Less than 0.3%
 (1kHz 75% mod.)

Signal to noise ratio More than 70dB
 (CX encoded disc, CX NR ON, 1kHz 650mV
 output, using IHF A network)

Frequency response . . . 40Hz to 20kHz (±3dB reference
 to 1kHz 10% mod.)

Functions

	CAV	CLV
Play (Normal play mode with sounds) . . .	YES	YES
Pause (Pause mode without picture and sounds)	YES	YES
Scan forward/reverse	YES	YES
Fast forward/reverse (Three times normal speed)	YES	NO
Slow forward/reverse (Variable speed control)	YES	NO
Still; Step forward/reverse	YES	NO
Frame number display (ON/OFF)	YES	NO
Elapsed time display (ON/OFF)	NO	YES
Chapter number display (ON/OFF)	*2	*2
Frame number search	YES	NO
Chapter number search	*2	*2
Chapter stop (With chapter number display)	*2	*2
Automatic picture stop (Special disc only) .	*3	NO
Remote control (Infrared wireless control)	YES	YES

Others

Power requirements AC 120V, 60Hz
 Power consumptions 85-watts
 Dimensions 525(W) x 408(D) x 143(H) mm.
 20-21/32(W) x 15-13/16(D) x 5-5/8(H) in.
 Net weight (without package) 13.5kg (29.8 lbs)
 Gross weight (with package) 16.5kg (36.4 lbs)

Furnished Accessories

RU-8210 remote control unit	1
Size "AA" dry battery	3
VHF connecting cable with F type plugs	1
Audio connecting cords with pinplugs	1
Antenna adapter (300Ω-to-75Ω)	1
75Ω(F-type jack)-to-300Ω converter	1
Operating instructions	1

NOTES:

Specifications and the design subject to possible modification without notice, due to improvements.

*1 Actual playback time differs for each disc.

*2 Only for discs recorded with chapter codes.

*3 Only for discs recorded with picture stop codes.

MAINTENANCE

Cleaning the player

- Use a soft, clean cloth to wipe off dust and dirt accumulated on the player. If necessary, moisten a soft cloth with diluted neutral detergent to remove heavy dirt.
- Never use paint-thinner, benzene or other solvents. They react with the surface and cause color changes and melting.

Objective lens care

- The objective lens is a key part of the player. Note that the lens surface must be clean in order to maintain the best performance. Never try to touch the lens surface. Keep the hood closed to keep out dust and dirt unless it is necessary to open for inserting and removing the disc. If too much dust or dirt accumulates, it may degrade the picture quality. Dust can be removed from the lens with an air blower for a camera lens.

Care and storage of videodiscs

- The videodisc, like an audio disc, is made of plastic and can be cared for in a similar fashion. The disc may be dusted with a clean soft cloth and safely cleaned using a mild plastic cleaner.
- While fingerprints on the disc will not affect the information stored on it, they may cut down on the amount of light reflected back from the information layer and thus detract from the quality of the picture. Consequently, handle the disc by its edges or between one edge and the large center hole to avoid touching the playing surface.
- Videodiscs should be stored in their jackets and in a vertical position, thus lessening the possibility of warpage. Discs should not be stacked one atop another. If a disc becomes excessively warped, the player will not be able to track it.