

JUNE 14, 1983

VIDEO DISC PLAYER

PR-7820

GENERAL ADJUSTMENT PROCEDURES

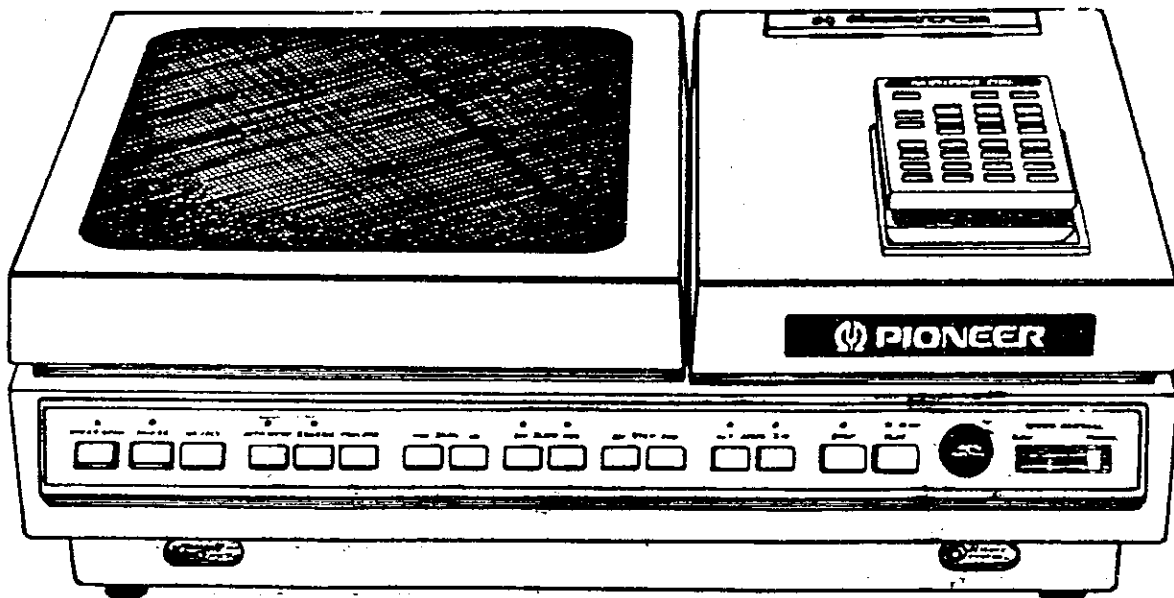

 PIONEER

DISC TO BE USED: B1 (A2)



NOTE: When viewing disc related signals (RF, FOCUS ERROR, TRKG ERROR, VIDEO, etc.), the scope may be triggered externally from SPDL TP 4.

This test point is accessible when VTBC/SPDL cardcage cover is removed.

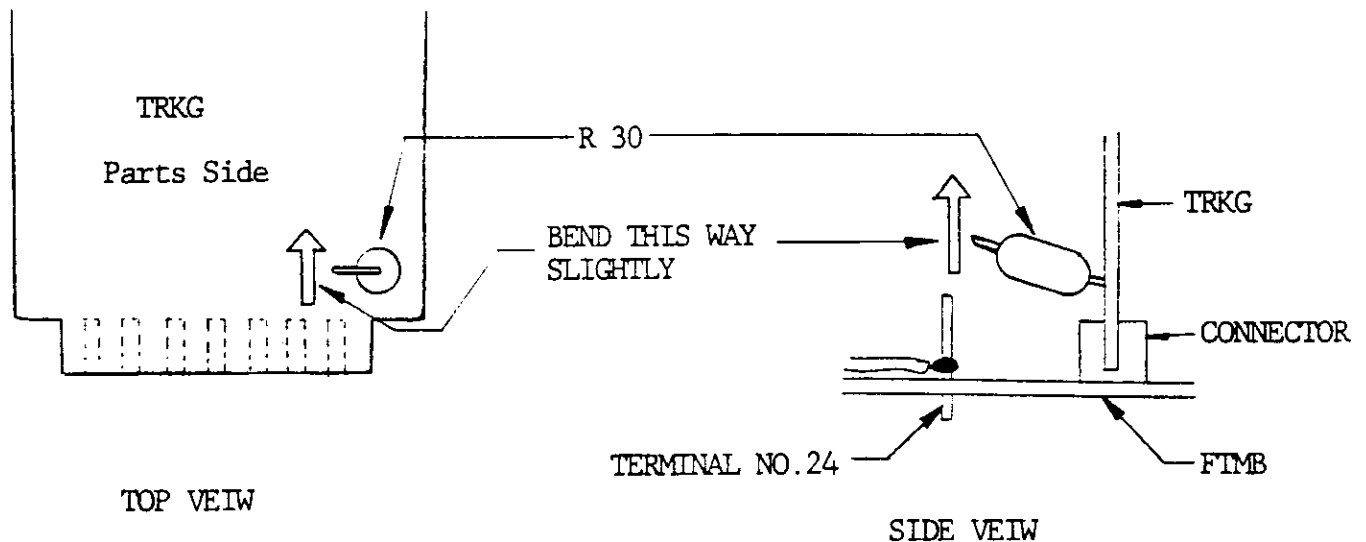
CAUTION: When the TRKG board is pulled out, be sure to bend R 30 (shown below) upward slightly to prevent an accidental touching of R 30 to the terminal No. 24 (shown below) on the FIMB when the TRKG board is reinstalled.

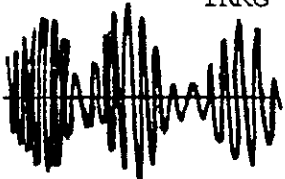
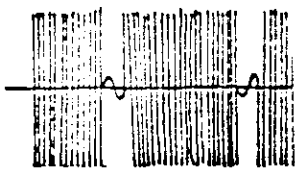

Use the small size extender board for TRKG, the medium size board for SPDL, and the large size board for VTBC adjustments.

STEP NO.	MODE	SCOPE RANGE	TEST POINT NO.	SERVO LOOP	ADJ. POINT	CHECK and ADJUSTMENT DETAILS
1	SET UP	0.05v/div	TRKG PIN 13	TRKG O/L	TRKG VR 3	<p><u>TRKG MIRROR BIAS CHECK/ADJUSTMENT</u></p> <p>Check that the voltage of TRKG mirror drive (PIN 13) is at 0V + 0.03V (Readjusting VR 3 on TRKG if necessary)</p>
2-0						<p><u>PLATFORM POSITION/GRATING ADJUSTMENT</u></p>
2-1	PLAY #20,000	5V/div 5msec/div	TRKG TP.1	TRKG O/L	PLATFORM	<p><u>INITIAL PLATFORM POSITION</u></p> <p>Adjust the platform position to obtain a maximum O/L TRKG signal near the center of the disc (approx. #20,000).</p> <p>The signal should be maximum and have a smooth (flat) envelop.</p> <p style="text-align: center;">TRKG O/L SIGNAL</p> <div style="display: flex; justify-content: space-around;">   </div> <div style="display: flex; justify-content: space-around; margin-top: 5px;"> INCORRECT CORRECT </div>
2-2	PLAY #20,000	5V/div 5msec/div	TRKG TP.1	TRKG O/L	FOCS VR 1	<p><u>OPTIMIZE FOCUS</u></p> <p>Adjust FOCS OFFSET VR 1 to obtain a maximum O/L TRKG signal.</p>
2-3	PLAY #40,000	5V/div 5msec/div	TRKG TP.1	TRKG O/L	GRATING	<p><u>GRATING ADJUSTMENT</u></p> <p>Scan to Fr. #40,000 and use a 1.5 mm hex driver to unlock the GRATING set screw. Using a philips screw driver, adjust until a smooth "null" appears in the O/L TRKG signal.</p> <p>Then adjust the GRATING screw CCW to the next maximum O/L TRKG signal. Relock the set screw observing the waveform.</p> <p>If the O/L TRKG signal is reduced when securing the set screw, readjust until the signal is maximized when the set screw is secured.</p> <p>NOTE: There are several "null" points; however, only smallest S/N "null" point is correct.</p> <div style="display: flex; justify-content: space-around; margin-top: 20px;">   </div> <div style="display: flex; justify-content: space-around; margin-top: 5px;"> CORRECT INCORRECT </div>

STEP NO.	MODE	SCOPE RANGE	TEST POINT NO.	SERVO LOOP	ADJ. POINT	CHECK and ADJUSTMENT DETAILS
----------	------	-------------	----------------	------------	------------	------------------------------

2-4

PLAY #100

5V/div
5msec/div

TRKG TP.1

TRKG O/L

PLATFORM

PLATFORM POSITIONING

Scan to Fr. #100 and fine adjust the platform to obtain the maximum O/L TRKG signal.

TRKG O/L SIGNAL

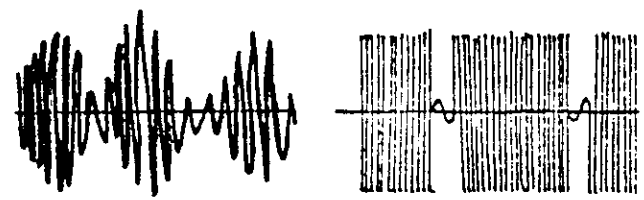

INCORRECT

CORRECT

2-5

PLAY #100 #40,000

5V/div
5msec/div

TRKG TP.1

TRKG O/L

PLATFORM POSITION/GRATING CHECK

While monitoring TP.1, verify that the value of the O/L TRKG signal at the outer radius (#40,000) should be at least 60% of the value of the signal at the inner radius (#100).

It may be necessary to repeat step 2-3, 2-4 to meet this requirement.

NOTE: The envelop of the O/L TRKG signal should be smooth (flat) throughout the disc.

3-0

PLAY #20,000 #40,000

2v/div
5msec/div

TRKG TP.1

TRKG O/L

TRKG VRI

TRKG SIGNAL OFFSET ADJ/DARK LEVEL CHECK

Adjust VRI so that the O/L TRKG signal is centered at GROUND.

(The positive and negative peak values should be equal with respect to OVDC.)

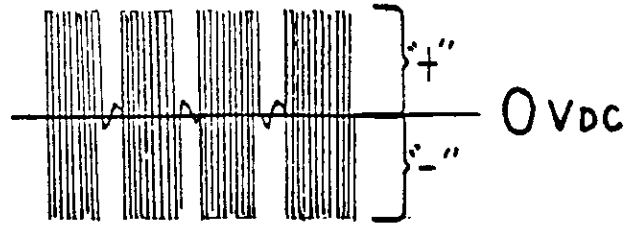

"+" = "-"

(Continued)

STEP NO.	MODE	SCOPE RANGE	TEST POINT NO.	SERVO LOOP	ADJ. POINT	CHECK and ADJUSTMENT DETAILS
4-0						<p>After the adjustment, reject the disc and check that the DC Level (E1) lies within the range below at TP.1.</p> $-0.7 \text{ V} < E1 < +0.7 \text{ V}$ <p>If (E1) is out of the range, then an optical alignment is necessary.</p> <p><u>FOCS OFFSET CHECKS AND ADJUSTMENTS</u></p>
4-1	PLAY #14,000	5v/div 5msec/div	TRKG TP.1	TRKG O/L	FOCS VRL	<p><u>FOCS OFFSET-MAXIMUM TRKG</u></p> <p>Adjust FOCS OFFSET VRL to obtain the maximum O/L TRKG signal. Note this FOCS OFFSET voltage (FOCS TP.1) as V_T. The FOCS OFFSET voltage is the average D.C. component of the FOCS ERROR signal at FOCS TP.1.</p>
4-2	STILL #100	0.5v/div 5msec/div	FMTP FOCS TP.1	TRKG C/L	FOCS VRL	<p><u>FOCS OFFSET -- MAXIMUM FM CHECK, CLOSE THE TRKG LOOP!</u></p> <p>The FM test point (FMTP) is located on the platform connector board.</p> <p>The left extended pin is the signal connector. The right is GND.</p> <p>Adjust FOCS OFFSET VRL to obtain maximum RF (FM) at FMTP.</p> <p>Note this FOCS OFFSET voltage (FOCS TP.1) as V_{FM}.</p> <p>V_T and V_{FM} should meet the following requirement:</p> $ V_T - V_{FM} \leq 0.7 \text{ V}$
4-3	STILL #100	0.5v/div (1v/div) 5msec/div	SCREEN FOCS TP.1	TRKG C/L	FOCS VRL	<p><u>DROP OUT TEST AND FINAL SETTING</u></p> <p>Set FOCS OFFSET VRL to the V_T Value</p> <p>While observing for drop outs on the screen, adjust the FOCS offset voltage (VRL) to $V_T+1.5\text{V}$ and $V_T-1.5\text{V}$.</p>

(Continued)

STEP NO.	MODE	SCOPE RANGE	TEST POINT NO.	SERVO LOOP	ADJ. POINT	CHECK and ADJUSTMENT DETAILS
						<p>A large number of drop outs should not appear on the screen at either the VT+1.5V or the VT-1.5V settings.</p> <p>If a large number of D.O.'s appear at either of the 1.5V extremes, set the FOCUS OFFSET back to VT value and perform step No. 7 (DOS sensitivity). Repeat step 4-C after the D.O.'s sensitivity has been completed.</p> <p>If a large number of DOS are still present at either of the 1.5V extremes, optical alignment is necessary.</p>

STEP NO.	MODE	SCOPE RANGE	TEST POINT NO.	SERVO LOOP	ADJ. POINT	CHECK and ADJUSTMENT DETAILS
4-0						<p align="center"><u>OPTIONAL FOCUS OFFSET ADJUSTMENT</u></p>
4-1	STILL #100	0.5/div 5msec/div	PLATFORM FMTP	TRKG C/L	FOCS VRI	<p align="center"><u>FOCUS OFFSET CHECK/ADJUSTMENT</u></p> <p>Adjust FOCS VRI to obtain maximum FM(RF). Measure and record average FOCS offset voltage at FOCS TP.1(E1) at Fr. #100.</p>
4-2	STILL #40,000	5v/div 5msec/div	TRKG TP.1	TRKG O/L	FOCS VRI	<p>Adjust FOCS VRI to obtain maximum FM(RF). Measure and record average FOCS offset voltage at FOCS TP.1(E2) at Fr. #40,000.</p>
4-2	#40,000	5v/div 5msec/div	TRKG TP.1	TRKG O/L	FOCS VRI	<p>Adjust FOCS VRI to obtain maximum O/L TRKG signal at TRKG TP.1. Measure and record average FOCS offset voltage at FOCS TP.1(E3) at Fr. #40,000.</p>
4-2	#100		FOCS TP.1			<p>Adjust FOCS VRI to obtain maximum O/L TRKG signal at TRKG TP.1. Measure and record average FOCS offset voltage at TP.1(E4) at Fr. #100.</p>
4-3	STILL #100	5v/div 5msec/div	FOCS TP.1	TRKG C/L	FOCS VRI	<p>E1, E2, E3 and E4 should meet the following requirements.</p> $\left \frac{E1 + E2}{2} - \frac{E3 + E4}{2} \right \leq 0.7V$ <p>If otherwise, optical alignment is necessary.</p> $E(\text{FOCS OFFSET}) = \frac{(E1+E2) + (E3+E4)}{4}$ <p>Adjust FOCS VRI to "E" (FOCS OFFSET) Voltage.</p>

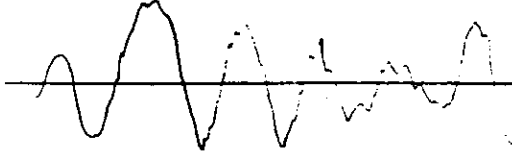
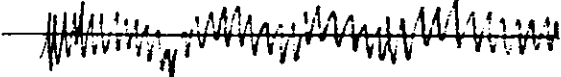
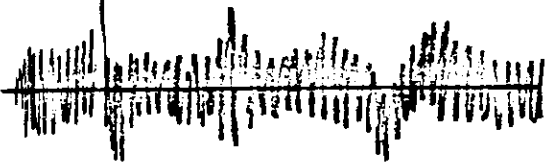
STEP NO.	MODE	SCOPE RANGE	TEST POINT NO.	SERVO LOOP	ADJ. POINT	CHECK and ADJUSTMENT DETAILS
5-1	STILL #40,000	1v/div 5msec/div	FOCS TP.1		FOCS VR2	<p data-bbox="862 268 1308 300"><u>FOCS GAIN COARSE ADJUSTMENT</u></p> <p data-bbox="862 331 1516 489">Observe the FOCS ERROR signal at TP.1 and adjust VR2 to minimize the low frequency FOCS ERROR as much as possible without producing a high frequency oscillation.</p>  <p data-bbox="964 789 1422 821">INCORRECT (Gain is too low)</p>  <p data-bbox="951 1178 1068 1209">CORRECT</p>  <p data-bbox="938 1566 1414 1598">INCORRECT (Gain is too high)</p>

STEP NO.	MODE	SCOPE RANGE	TEST POINT NO.	SERVO LOOP	ADJ. POINT	CHECK and ADJUSTMENT DETAILS
5-2	STILL #20,000	X-Y	FOCS TP.1 Z 5 PIN 9		FOCS VR2	<p><u>FOCS GAIN FINE ADJUSTMENT</u></p> <p>Set the oscilloscope into X-Y mode, and also set the SG output to:</p> <p>1.55kHz for B1 test disc, 2V_{p-p} (1.7 kHz for A2 test disc), 2V_{p-p}</p> <p>Connect the CH-X of the scope and the SG, then apply the SG output to PIN 9 of Z 5 (FOCS) thru the resistor (100 kohm). Connect the CH-Y to FOCS TP.1, then adjust the VR 2 to make the lissajoue's figure into a horizontal ellipse. (It means the phase shift between CH-X and CH-Y is adjusted to 90 degrees.)</p> <p>1.55kHz for B1 (1.7 kHz for A2)</p>

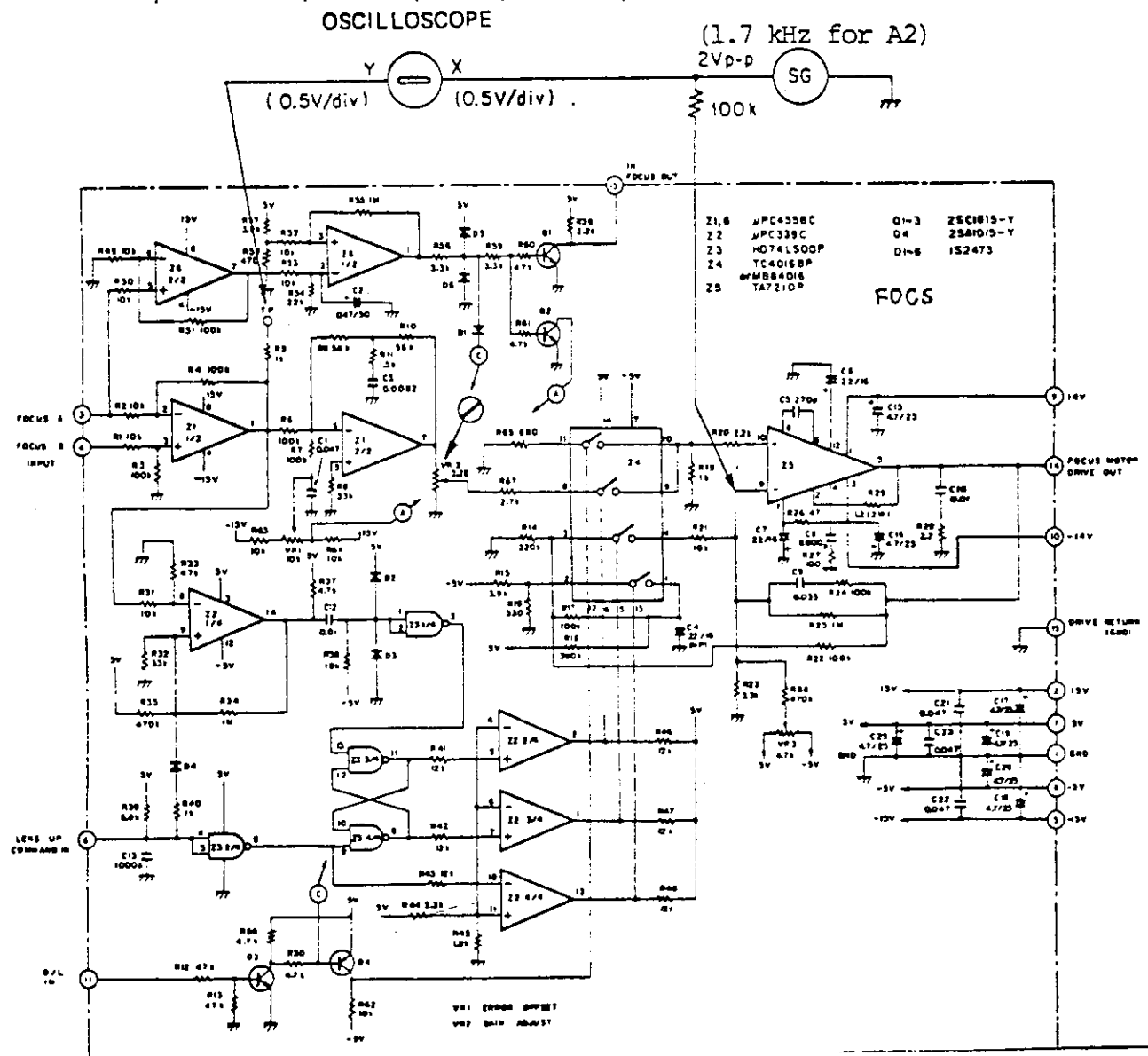

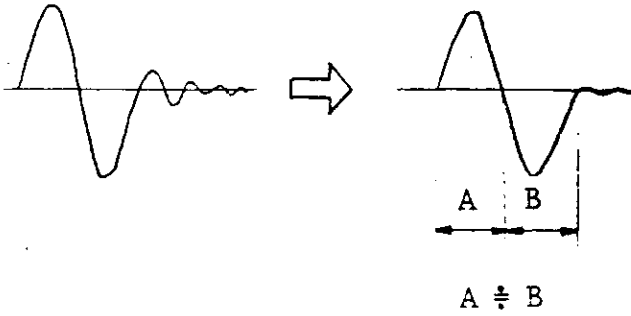
STEP NO.	MODE	SCOPE RANGE	TEST POINT NO.	SERVO LOOP	ADJ. POINT	CHECK and ADJUSTMENT DETAILS
6-1	STILL #20,000	2V/div (5V/div) 50µsec/div	TRKG TP.1	TRKG C/L	TRKG VR 2	<p data-bbox="873 279 1317 310"><u>TRKG GAIN COARSE ADJUSTMENT</u></p> <p data-bbox="873 373 1498 443">Use delayed time base to view expanded Jump pulse.</p> <p data-bbox="873 474 1498 604">Adjust VR 2 to minimize any overshoot or ringing immediately following the primary jump pulse and to equalize the width of positive and negative pulse.</p> <div data-bbox="878 751 1507 1066">  <p data-bbox="1328 1035 1422 1066">$A \approx B$</p> </div>

STEP NO.	MODE	SCOPE RANGE	TEST POINT NO.	SERVO LOOP	ADJ. POINT	CHECK and ADJUSTMENT DETAILS
6-2	STILL #20,000	X-Y	TRKG TP.1 Z 3 PIN 10		TRKG VR 2	<p><u>TRKG GAIN FINE ADJUSTMENT</u></p> <p>Set the oscilloscope into X-Y mode, and also set the SG output to:</p> <p>3.35 kHz for B1 test disc, $2V_{p-p}$ (3.2 kHz for A2 test disc), $2V_{p-p}$</p> <p>Connect the CH-X of the scope and the SG, then apply the SG output to PIN 10 of Z 3 (TRKG) thru the resistor (100 kohm).</p> <p>Connect the CH-Y to TRKG TP.1, then adjust the VR 2 to make the lissajoue's figure into a horizontal ellipse.</p> <p>(It means the phase shift between CH-X and CH-Y is adjusted to 90 degrees.)</p>

3.35kHz for B1
(3.2 kHz for A2)

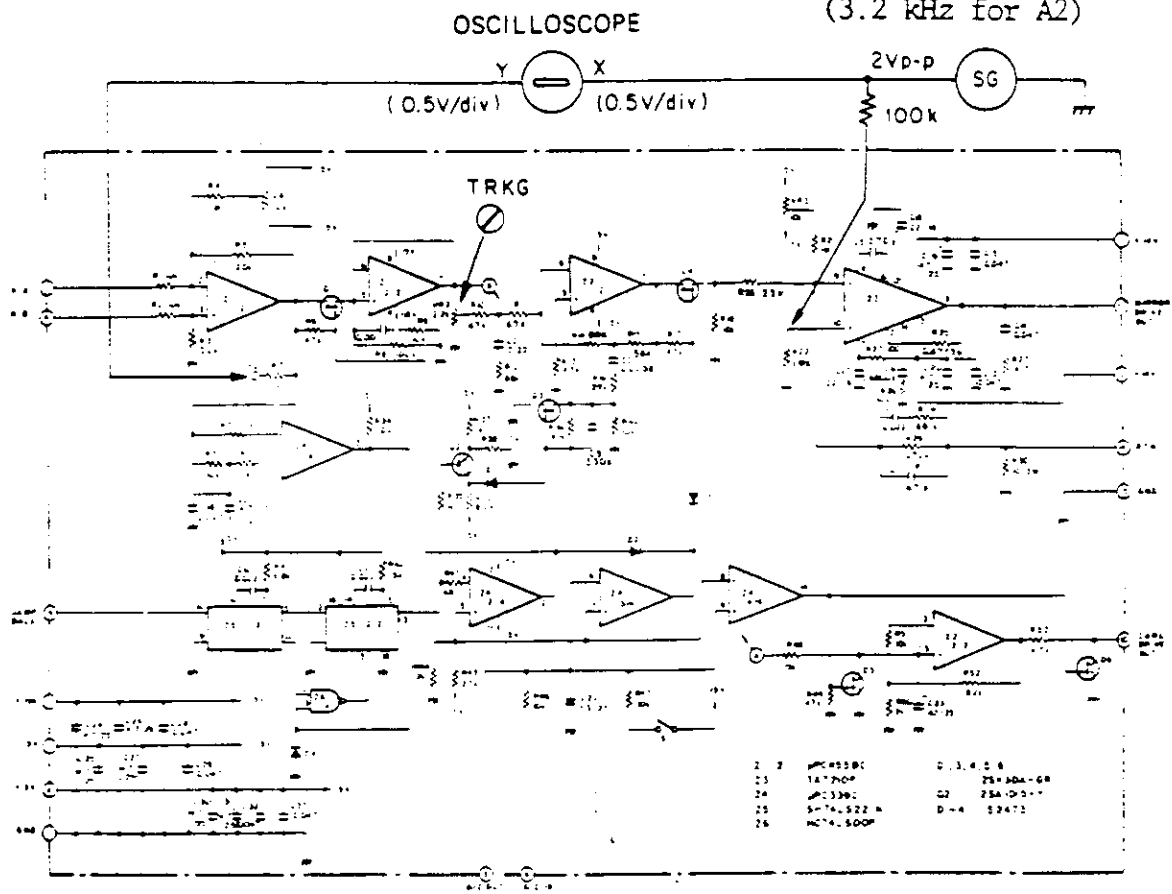

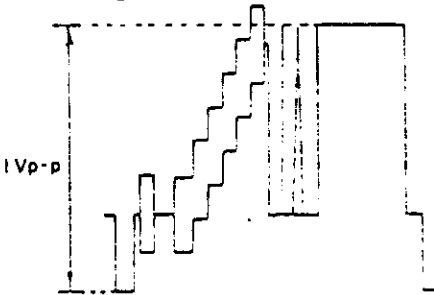
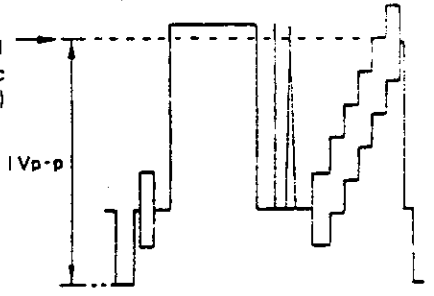
STEP NO.	MODE	SCOPE RANGE	TEST POINT NO.	SERVO LOOP	ADJ. POINT	CHECK and ADJUSTMENT DETAILS
7-0	STILL #100		TV SCREEN		VDEM VR 1 VR 5	<p><u>DOS SENSITIVITY ADJUSTMENT</u></p> <p>Slowly turn VR 1 CCW until many DROP OUTs appear on the screen.</p> <p>Adjust VR 5 to minimize the number of D.O.'s.</p> <p>Turn VR 1 fully CW.</p>
8-0	STILL #100	0.2V/div 10µsec/div	VDEM Negative leg of C73		VDEM VR 3	<p><u>VDEM VIDEO LEVEL ADJUSTMENT</u></p> <p>Adjust VR 3 to obtain 1Vp-p video level.</p> <p>Level setting for B1 test disc</p>  <p>Use this level (test disc B1)</p> <p>Level setting for A2 test disc</p>  <p>Use this level (test disc A2 only)</p>
9-0	STILL #100	0.2V/div 0.2V/div 10µsec/div	VDEM TP.7 TP.8		VDEM VR 4	<p><u>DELAY VIDEO LEVEL ADJUSTMENT</u></p> <p>AC couple input to channel 1 & 2 on the scope. Expand time scale to view 1 TV line.</p> <p>Overlay TP.7 with TP.8 on the scope. Adjust VR 4 to obtain equal video levels.</p>

ELECT

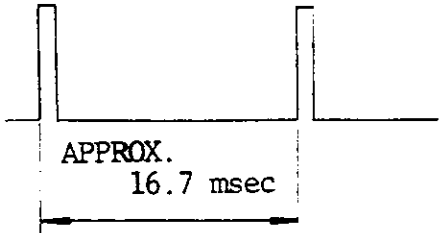
STEP NO.	MODE	SCOPE RANGE	TEST POINT NO.	SERVO LOOP	ADJ. POINT	CHECK and ADJUSTMENT DETAILS
10-0 10-1	STILL #100	1V/div 2msec/div	SPDL Z 9 PIN 1 Z 14 PIN 7 Jumpered to GND		SPDL VR 5	<p><u>SPDL SERVO ADJUSTMENT</u> <u>SPDL FREE RUN SPEED</u> Observe the waveform at Z9, PIN 1</p> <p>Adjust VR 5 to obtain 16.7 msec with PIN 7 jumpered to GND.</p>  <p>TP (Z9, PIN 1) = 16.7 msec ÷ 1800 rpm. If a frequency counter is available, adjust Z9, PIN 1 to 30Hz.</p> <p>Note: For PR-7820 players with PM 23B SPDL INTERLOCK option, the FREE RUN SPEED should be adjusted following procedure: See SI-830101.</p>
10-2	PLAY #100	1.0v/div (0.5v/div)	SPDL TP.8		SPDL VR 2	<p><u>REFERENCE PRESET ADJUSTMENT</u> This is a preset adjustment. Adjust VR2 (reference delay) to middle of mechanical range.</p>
10-3			SPDL TP.8		SPDL VR 4	<p><u>SPDL PRESET H. ERROR OFFSET</u> Monitor the H.error. and adjust VR 4 to center the 30Hz AC component to 0V (approximate adjustment). Ensure that SPDL LOCK is maintained.</p>
10-4		0.5v/div 0.5v/div 5msec/div	SPDL TP.8 TP.11		SPDL VR 4 VR 3	<p><u>SPDL TACHO RANGE & H.ERROR OFFSET</u></p> <p>Adjust the tachoeerror offset VR 3 slowly to the average D.C. value of -0.5v. Press REJECT & PLAY and ensure that SPDL LOCK is quickly achieved. If SPDL LOCK is not obtained, adjust H.error offset VR 4 until SPDL LOCK is obtained.</p> <p>When SPDL LOCK is obtained at -0.5v of tachoeerror offset voltage, adjust VR 3 to +1.25v and confirm SPDL LOCK is same as above. Then readjust VR 3 to obtain average D.C. value of 0V at TP11.</p>

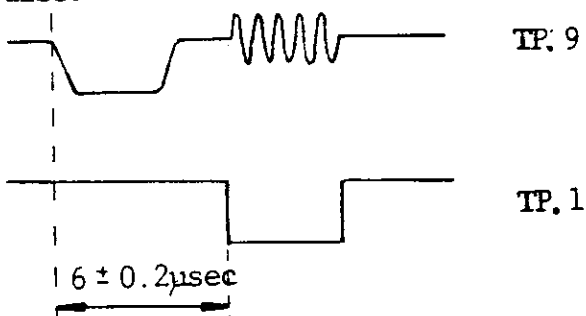
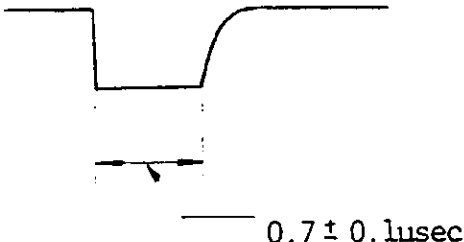
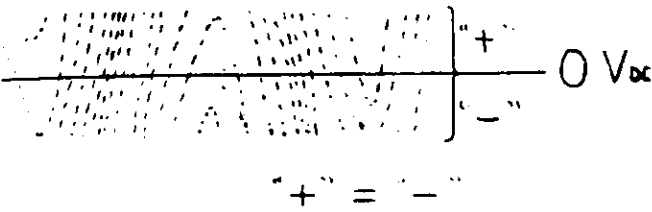
STEP NO.	MODE	SCOPE RANGE	TEST POINT NO.	SERVO LOOP	ADJ. POINT	CHECK and ADJUSTMENT DETAILS
11-0						<p><u>VIDEO TIMEBASE CORRECTOR (VTBC) ADJUSTMENT</u></p> <p>NOTE: There are two types of VTBC printed circuit boards.</p> <p>(a) Type VW-003 provides a switch to open & close the time base corrector servo loop.</p> <p>(b) Type VW-005 provides two test points (TP.11 & TP.12) which must be shorted together to open the time base corrector servo loop.</p>
11-1	PLAY #100	CH.1 0.5V/div (TP.9) CH.2 2V/div (TP.1) 2μsec/div Trigger on negative edge of sync tip (CH.1)	VTBC TP.9 TP.1	VTBC O/L	VTBC VR 1	<p><u>BURST GATE TIMING</u></p> <p>Adjust VR 1 to position the negative edge of the burst gate $6 \pm .2\mu\text{sec}$ after the negative edge of the sync pulse.</p>  <p>TP. 9</p> <p>TP. 1</p> <p>$6 \pm 0.2\mu\text{sec}$</p>
11-2		2V/div 0.5μsec/div	VTBC TP.2	VTBC O/L	VTBC VR 2	<p><u>SAMPLE PULSE WIDTH ADJUSTMENT</u></p> <p>Trigger on negative edge. Adjust VR 2 to obtain pulse width of $0.7 \pm 0.1\mu\text{sec}$.</p>  <p>$0.7 \pm 0.1\mu\text{sec}$</p>
11-3		2V/div 5msec/div	VTBC TP.4	VTBC O/L	VTBC VR 4	<p><u>ERROR OFFSET ADJUSTMENT</u></p> <p>Adjust VR 4 to center the wave form around 0V.</p>  <p>0 V_{dc}</p> <p>"+" = "-"</p>

STEP NO.	MODE	SCOPE RANGE	TEST POINT NO.	SERVO LOOP	ADJ. POINT	CHECK and ADJUSTMENT DETAILS
----------	------	-------------	----------------	------------	------------	------------------------------

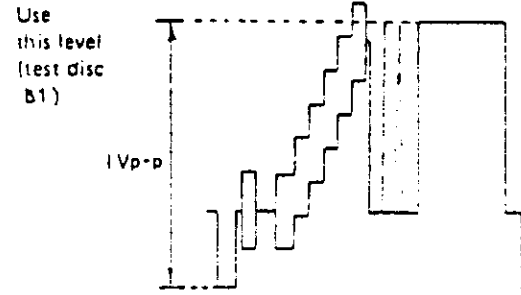
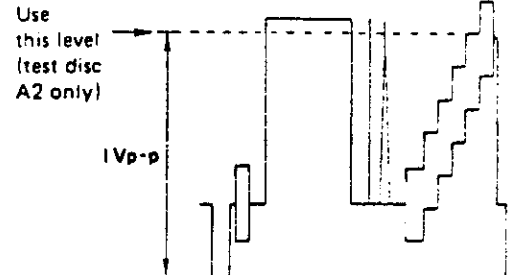
11-4	STILL #100	0.2V/div 10µsec/div	LINE-OUT with 75ohm termination	VTBC C/L	VTBC VR 10	<p><u>CLOSE THE VTBC LOOP!</u></p> <p>NOTE: Ensure that the VIDEO LINE OUTPUT is terminated</p> <p>Adjust VR 10 to obtain $1V \pm 0.1V_{pp}$ Video level at the LINE OUTPUT shown below.</p> <p>Level setting for B1 test disc</p>  <p>Level setting for A2 test disc</p> 
------	------------	------------------------	---------------------------------	----------	------------	--

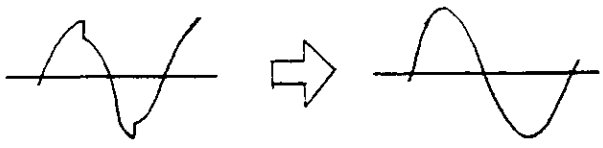
11-5	PLAY #100	1V/div 5msec/div	VTBC TP.6		VTBC VR 5	<p><u>H.ERROR INJECTION LEVEL</u></p> <p>Adjust VR 5 to minimize the step component and produce a smooth 30Hz waveform at TP.6 (TP.6 is a terminal on the shield case).</p> 
------	-----------	---------------------	-----------	--	-----------	--

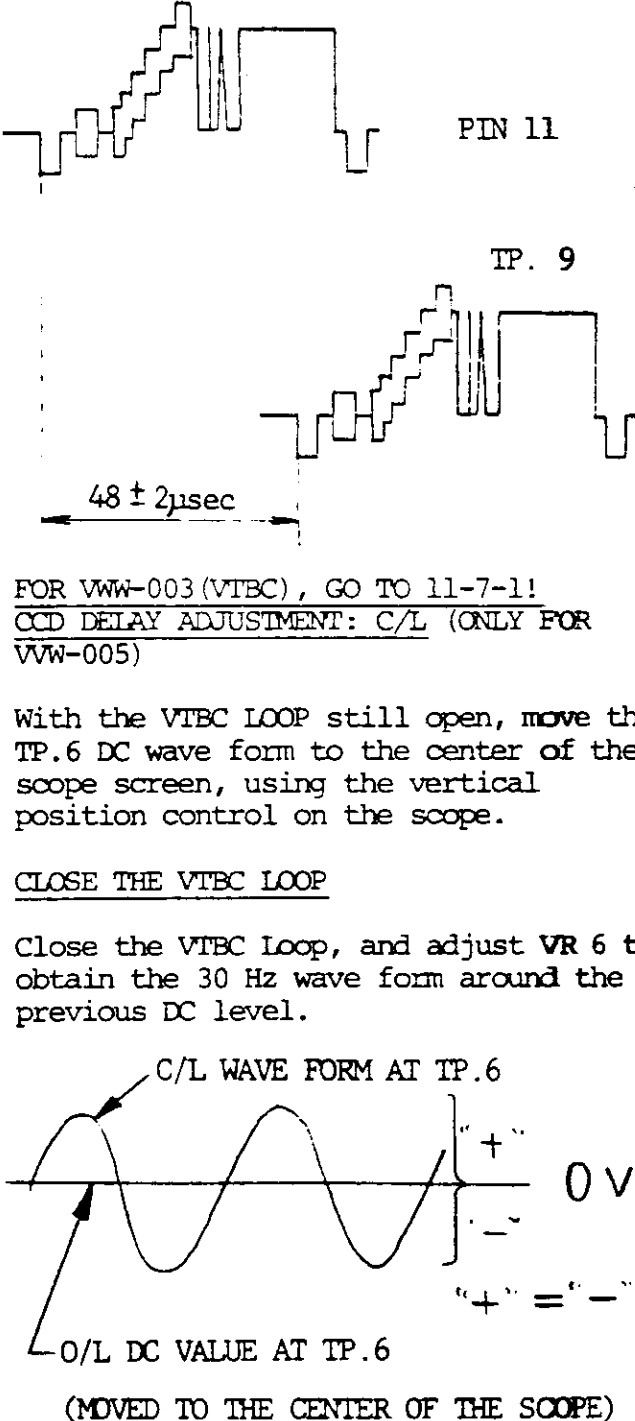
STEP NO.	MODE	SCOPE RANGE	TEST POINT NO.	SERVO LOOP	ADJ. POINT	CHECK and ADJUSTMENT DETAILS
11-6	PLAY #100	CH.1 0.5V/div (PIN 11) CH.2 1V/div (TP.9) 10μsec/div	VTBC PIN 11 (TERMINAL) TP.9	VTBC O/L	VTBC VR 7	<p><u>OCD DELAY ADJUSTMENT: O/L</u></p> <p><u>OPEN THE VTBC LOOP</u></p> <p>Trigger on CH.1 (PIN 11) negative edge of sync. tip.</p> <p>Adjust VR 7 so that the TP.9 waveform is delayed 48 + 2μsec from PIN 11 waveform (See figure below).</p>
11-7	PLAY #100	0.5v/div 5msec/div DC-coupled	VTBC TP.6	VTBC O/L & C/L	VTBC VR 6	<p><u>FOR VVW-003 (VTBC), GO TO 11-7-1!</u></p> <p><u>OCD DELAY ADJUSTMENT: C/L (ONLY FOR VVW-005)</u></p> <p>With the VTBC LOOP still open, move the TP.6 DC wave form to the center of the scope screen, using the vertical position control on the scope.</p>
ONLY FOR VVW-005						<p><u>CLOSE THE VTBC LOOP</u></p> <p>Close the VTBC Loop, and adjust VR 6 to obtain the 30 Hz wave form around the previous DC level.</p>  <p>(MOVED TO THE CENTER OF THE SCOPE)</p>

15

STEP NO.	MODE	SCOPE RANGE	TEST POINT NO.	SERVO LOOP	ADJ. POINT	CHECK and ADJUSTMENT DETAILS
----------	------	-------------	----------------	------------	------------	------------------------------

11-7 -1	PLAY #100	CH.1 0.5V/div (PIN 11) CH.2 1V/div (TP.9) 10µsec/div	VTBC PIN 11 (TERMINAL) TP. 9	VTBC C/L	VTBC VR 6
------------	--------------	--	---	-------------	--------------

ONLY FOR VWW-003

CCD DELAY ADJUSTMENT: C/L (ONLY FOR VWW-003)

Adjust VR 6 so that the TP.9 waveform is delayed 48 + 2µsec from PIN 11 waveform (See Figure below).

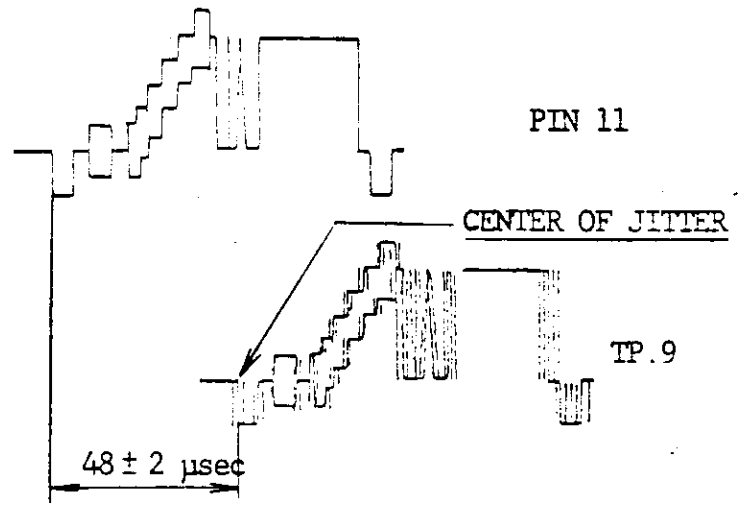

A2 TEST DISC

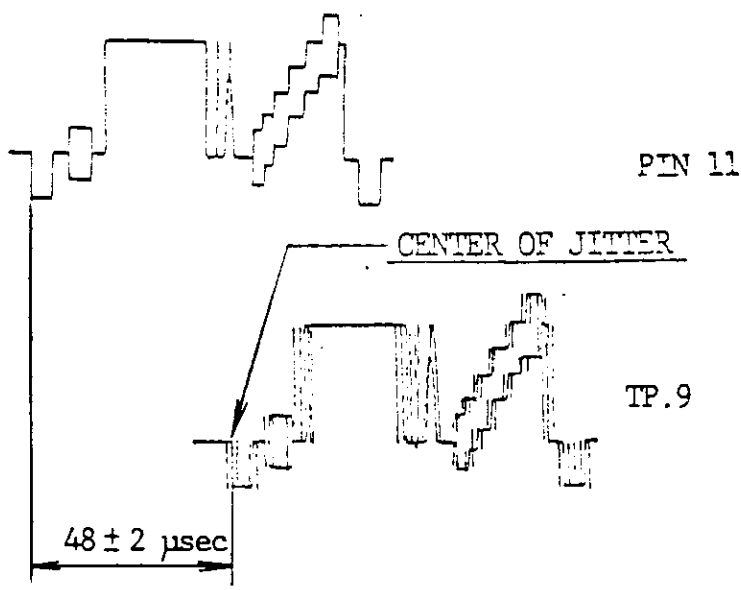

STEP NO.	MODE	SCOPE RANGE	TEST POINT NO.	SERVO LOOP	ADJ. POINT	CHECK and ADJUSTMENT DETAILS
----------	------	-------------	----------------	------------	------------	------------------------------

11-8	STILL #100	0.5V/div 5nsec/div	VTBC TP.8	VTBC C/L	VTBC VR 3
------	------------	-----------------------	-----------	----------	-----------

DC DRIFT CANCELLATION

(VWV-005 Only)
Adjust VR 3 to minimize the 30 Hz component in the TP.8 video signal.

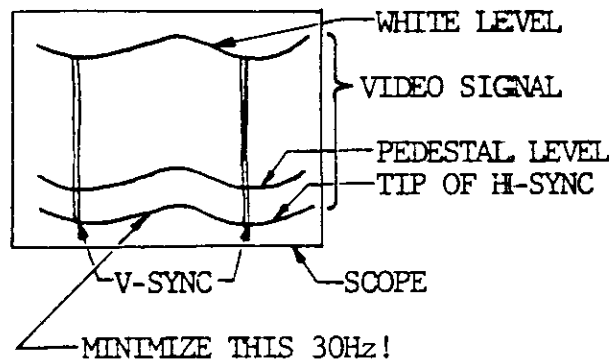

11-9	STILL #100	1V/div (TP.9) 2V/div (TP.1) 10µsec/div	VTBC TP.9 SPDL TP.1	VTBC C/L	VTBC VR 2
------	------------	--	------------------------	----------	-----------

SPDL REFERENCE DELAY
Trigger on TP.1.

Adjust VR 2 on the SPDL to align the positive going edge of the SPDL TP.1 square wave with the negative going edge of the VTBC TP.9 playback video H-sync. (Specification rating: ± 1µsec)

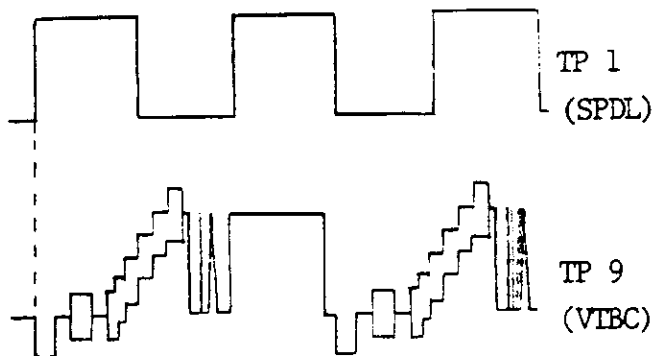

STEP NO.	MODE	SCOPE RANGE	TEST POINT NO.	SERVO LOOP	ADJ. POINT	CHECK and ADJUSTMENT DETAILS
12-0	PLAY #2701 ~ #3600 for B1 ----- #2701 ~ #4500 for A2 -----	50mV/div 5msec/div	AUDIO LINEOUT CH1 CH2		ACOM VR 1 (CH 1) VR 2 (CH2)	<u>ACOM ERROR CANCELLATION</u> a) With Ch.1 on, Ch.2 off, adjust VR 1 (inside pot) to minimize the 30 Hz component. b) With CH.1 off, Ch.2 on, adjust VR 2 (outside pot) to minimize the 30 Hz component.
13.0	PLAY		TV SCREEN		D & CR VR 1	<u>VALID DATA ADJUSTMENT</u> Display the Frame number on the TV screen. Adjust VR 1 CCW until frame number stops counting and note the position of VR 1. Then, adjust VR 1 CW until frame number stops counting again and note the position of VR 1. Set VR 1 midway between these two positions.
14.0	PLAY		TV SCREEN		DSPL VR2	<u>INSIDE ANTICIPATION ADJUSTMENT</u> Display the Frame number on the TV screen. With the unit in PLAY mode, SCAN FORWARD to a point on the disc above frame #3000. Then SCAN REVERSE towards inside while observing the frame display's rate of change. Adjust VR 2 until a visually noticeable reduction in the frame display's rate of change occurs at frame number 600 (+200, -100). (This change of the SCAN rate can be audibly detected.)
15.0	PLAY		TV SCREEN		DSPL VR 1	<u>OUTSIDE LIMIT ADJUSTMENT</u>
15.1						<u>COARSE ADJUSTMENT</u> SCAN FORWARD toward the outer radius. Adjust VR 1 until a visually noticeable reduction in the frame display's rate of change occurs at frame number: For B1, at #49600 ("100, -100). For A2, at #49300 ("300, -200).

STEP NO.	MODE	SCOPE RANGE	TEST POINT NO.	SERVO LOOP	ADJ. POINT	CHECK and ADJUSTMENT DETAILS
15-2						<p><u>FINE ADJUSTMENT</u> With the player in the PLAY mode at the outside diameter (about 49,000), adjust VR1 so that . . .</p> <p>a) For Model I & II: For A2: Reject automatically occurs 7-13 seconds after the character "19" appears on the screen. For B1: Reject automatically occurs between the character "10" and "17".</p> <p>b) For Model III: For both B1 and A2: Kick back instead of reject occurs at above description.</p>

16-0

This adjustment is necessary only if problem is encountered with "loading," "Program dump" or "external computer communication."

MICROPROCESSOR CLOCK FREQUENCY ADJUSTMENT

NOTE: Requires frequency counter and non-metallic/plastic screwdriver for adjustment.

Adjust microprocessor clock frequency, VC1 on MCPR, to 2.040 ± 0.010 MHz when the player is cold. The clock signal is most easily read at Z11 pin 2. (Caution: Pin 1 is +12 volts.) Adjustment should be made with no disc on the machine. CARG board may be removed for easier access to VC1. The piggyback RAM board will have to be moved if the microprocessor is so equipped.

If the machine has been operating more than 15 minutes, player has to be cooled down.

Refer to Service Manual pages 42 & 145.